

The **Whole** Mac[®]

SOLUTIONS

for the

creative

professional



The **Whole** Mac®

Daniel Giordan

Kelley Boylan

Brendan Donohoe

Michelle Szabo

Dave Teich

Kate Binder

Kathy Kozel

Bill Parsons

Carla Rose

Beverly Scherf

Tim Webster

Mike Zender

Stella Gassaway



The Whole Mac: Solutions for the Creative Professional

©1996

All rights reserved. Printed in the United States of America. No part of this book may be used or reproduced in any form or by any means, or stored in a database or retrieval system, without prior written permission of the publisher except in the case of brief quotations embodied in critical articles and reviews. Making copies of any part of this book for any purpose other than your own personal use is a violation of United States copyright laws. For information, address Hayden Books, 201 W. 103rd Street, Indianapolis, Indiana 46290.

Library of Congress Catalog Number: 96-77063

ISBN: 1-56830-298-3

Copyright © 1996 Hayden Books

Printed in the United States of America 1 2 3 4 5 6 7 8 9 0

Warning and Disclaimer

This book is sold as is, without warranty of any kind, either express or implied. While every precaution has been taken in the preparation of this book, the authors and Hayden Books assume no responsibility for errors or omissions. Neither is any liability assumed for damages resulting from the use of the information or instructions contained herein. It is further stated that the publisher and authors are not responsible for any damage or loss to your data or your equipment that results directly or indirectly from your use of this book.

Publisher

Lyn Blake

Publishing Manager

Laurie Petrycki

Managing Editor

Lisa Wilson

Development Editor

Steve Mulder

Project Editor

Dennis Hamilton

Copy/Production Editor

Bront Davis

Publishing Coordinator

RoseMary Lewis

Cover Designer

Aren Howell

Book Designer

Gary Adair

Manufacturing Coordinator

Brook Farling

Production Team Supervisor

Laurie Casey

Proofreaders

Heather Butler

Pamela Volk

Page Layout

Terrie Deemer

Joe Millay

Indexer

Erika Millen

About the Authors

Daniel Giordan is an artist and author based in Southbury, CT. His paintings and images have been exhibited in major galleries and museums throughout the northeast, and his design and consulting clients are among the top print and advertising clients in the nation.

His first book, *Kai's Magic Toolbox*, explores the innovative creations of Kai Krause and MetaTools, profiling Live Picture, KPT 3.0, KPT Convolver, and KPT Bryce. It provides a unique insight into the programs, as well as the process of how they should be applied. *Kai's Magic Toolbox* is also published by Hayden Books.

"*The Whole Mac* is destined to be a valuable industry resource for years to come, and I'm happy to be included among its authors."

Kelley Boylan has co-authored three other books—*Upgrading and Repairing Macs*, *Office 4.2 and the Mac*, and *Internet with Your Mac*—and has written for *MacWeek* and *MacUser*. He is a freelance system administrator and technical writer, writing for companies including IBM (PowerPC ABI), Motorola (6800-series microprocessor), and Andersen Consulting (Foundation Install/1), among others. As an administrator he has installed, upgraded, and maintained systems, including AIX on RS/6000s, DOS, OS/2 Windows, and Windows on PCs and, of course, Macs of all kinds. A confirmed Macaholic, he owns no other platforms.

Brendan Donohoe has been creating graphics on the Macintosh since 1984. Armed with MacPaint and a Macintosh 128k, he has been painting, drawing, modeling, and animating ever since. Currently living in Amherst, Massachusetts, Brendan is employed by Specular International, makers of standard-setting graphics software for the Macintosh. Brendan is also the co-author of *Infini-D Revealed*, a book about Specular's award-winning flagship product, Infini-D. In his off-time, Brendan writes, produces graphics, and sometimes even shuts off the computer to get some fresh air. He is glad to have contributed to *The Whole Mac*, the first everything-Macintosh book to concentrate on the people who first recognized the power of the Macintosh, graphics artists.

Michelle Szabo/New Media Designs creates 2D and 3D graphics for video, CD-ROM, the World Wide Web, and print. Their digital repertoire includes: Infini-D, form•Z, Premiere, Photoshop, Illustrator, and Director. Michelle teaches 3D design at the School of Visual Arts and Apple Computer and privately trains corporate clients to use digital tools for design and production.

<http://www.newmediadesigns.com>

mszabo@newmediadesigns.com

Dave Teich/Mind of the Machine is a digital studio creating 2D and 3D graphics for multimedia, video, and print. Specializing in 3D modeling and animation, Photoshop, form•Z, Electric Image, and After Effects, Dave is a Macintosh consultant and trainer and teaches at the School of Visual Arts and Apple Computer, New York City.

<http://bird.taponline.com/mindmachine/mom.html>

mindmachine@marketsource.com

Kate Binder is a production artist and writer living on the north shore of Massachusetts. She has written about desktop publishing for magazines, including the *National Association of Desktop Publishers Journal*. She also contributed to *Maclopedia*. She can be reached at UrsaDesign@aol.com. Kate is acknowledged as the Queen of Desktop Publishing by several people, including her cats.

Kathy Koziel is a freelance multimedia developer. She has been designing and programming interactive software since 1987.

Her most recent project was the *TerraTopia* CD-ROM title for Virgin Sound & Vision. Kathy teaches multimedia authoring and Macromedia Director for UCLA Extension, and she founded the Los Angeles Lingo User Group. She is currently a contributing editor for *CD-ROM Professional* magazine.

At home, she has four frequently used Macs and one dusty IBM. Kathy was thrilled to work on a Macintosh book for creative professionals, and knows, for a fact, that people who work on Macs are more productive, inspired, and attractive.

Bill Parsons is a teacher, writer, freelance graphics designer, and electronic publishing consultant. He holds an MFA from the University of Texas at Austin and a BFA from the University of North Texas. Mr. Parsons was also a contributor to *Maclopedia* by Hayden Books.

Carla Rose, after graduating from the School of the Museum of Fine Arts in Boston, discovered that she could write better than she could draw. She gave up a promising career in art (it promised to go nowhere), and became an advertising copywriter. Years later she discovered the Mac, and found that computer art was fun and less messy. Her fondness for computers led to a monthly column in *Portable Computing* magazine and a dozen books that she has authored/co-authored, including *Maclopedia*. About *The Whole Mac* she says, "If I'd had this book and a Mac 20 years ago, I'd never have wasted all that time writing."

Beverly Scherf, president of möbius communications, has edited and designed for Simon & Schuster and Macmillan for over six years. She has been involved in the publication of Macintosh computer books since their inception in the '80s.

Beverly's commitment to quality and excellence in communication and presentation has led her to work on multiple publications as a developmental editor, cowriter, author, and designer in books that range from political risk to high-tech computer applications. Living in Santa Rosa, California, some of her other interests include Latin, the Celtic harp, and birding.

Tim Webster is *still* employed (to everyone's continued surprise) in the demilitarized zone between design and prepress. He enjoys food and noise, and lives with his wife Chris Corcoran, on the south side of Chicago—the baddest part of town. Tim climbed on the Mac wagon 10 years ago to make posters for his band, the late, great, Angry Young Men. He has been riding it for fun and profit ever since.

Tim is the co-author of *Mastering Netscape 2.0 for Macintosh*, and a contributor to both *Teach Yourself Java in 21 Days for Macintosh* and *Maclopedia*.

Mike Zender is a third-generation designer/typesetter, following in the footsteps of his father and grandfather. Mike has been the beneficiary of an excellent education, first attending the University of Cincinnati, then completing graduate studies at Yale University under many of this century's best designers. He founded Zender + Associates, Inc., one month after completing school and began part-time teaching one year later. Mike's work and that of the associates in his firm have been published regularly since 1980.

Mike co-authored *Designer's Guide to the Internet*, published by Hayden Books.

Mike lives in southwestern Ohio with his high school sweetheart and three amazing children. Designing, writing, and teaching are outward expressions of his introspective and thoughtful personality.

Stella Gassaway Over her 20 years of professional experience as a graphics designer, Stella has been consistently at the bleeding edge in the use of digital tools. Trained in graphics design at Parsons School of Design and SVA in New York City, her early years were primarily in book and publication design being unconventional with conventional tools.

For the past 10 years she has had her own graphics design studio: STELLARViSIONs. The Macintosh computer was introduced at the nascence of the firm with a MacPlus and a 20 meg external drive the size of a breadbox. Far in advance of most studios, STELLARViSIONs was exploring the avenues opened by the use of the Macintosh as a design and production tool.

Stella was also the technical editor of *Designer's Guide to the Internet* written by Zender + Associates and published by Hayden Books.

Trademark Acknowledgments

All terms mentioned in this book that are known to be trademarks or service marks have been appropriately capitalized. Hayden Books cannot attest to the accuracy of this information. Use of a term in this book should not be regarded as affecting the validity of any trademark or service mark. Macintosh is a trademark of Apple Computers, Inc.

Hayden Books

The staff of Hayden Books is committed to bringing you the best computer books. What our readers think of Hayden is important to our ability to serve our customers. If you have any comments, no matter how great or how small, we'd appreciate your taking the time to send us a note.

You can reach Hayden Books at the following:

Hayden Books
201 West 103rd Street
Indianapolis, IN 46290
(800) 428-5331 voice
(800) 448-3804 fax

Email addresses:

America Online: Hayden Bks
Internet: hayden@hayden.com

Visit the Hayden Books Web site at <http://www.hayden.com>

About The Ratings

How do we creative professionals really feel about the tools we use?

Well, I set out to get some answers.

With some help from Steve Mulder at Hayden Books and the other contributors to *The Whole Mac*, we developed a list of software and hardware. You'll find the results sprinkled through the book including some very opinionated comments from the participants.

The survey was constructed as HTML pages that were hung at designOnline (www.do1.com), an online service for designers of all disciplines. This ensured exposure to designers from all over the world who would be willing to speak out about the state of the Macintosh. I announced the survey via email to my colleagues, including those in the American Institute for Graphic Arts, American Center for Design, and posted a notice about it to various lists including the MacWay list.

The opening page at the Web site was a list of links to survey pages, each representing a category of products (e.g. monitors). Participants were asked to choose the categories they knew best (they did not have to answer the entire survey).

The participants were asked to rate only those products with which they were familiar. The instructions were simple: answer honestly and ruthlessly using a scale of 1 [worst] to 5 [best].

Four attributes were rated:

- ease of use
- great features
- coolness [gotta have it]
- value [bang per buck]

The participants also gave an overall rating for the product. These scores are not statistical combinations of the first four scores. In other words, we did not weigh the four aspects of the product to produce the overall rating. If "ease of use" was most important to a participant, he or she might have given a product a high overall score despite low scores for "coolness" or whatever.

I also asked participants to let me know if there was some terrific tool I had overlooked. There was an enthusiastic response to this invitation—we creative professionals are an opinionated bunch!

I want to thank everyone that participated, taking time out of trying to make deadlines (and trying to make a living) to answer thoughtfully and share their insights with their colleagues, and most of all, I would like to thank those who were willing to share tips, tricks, and stories—taking valuable time to give us invaluable information. I hope you get as much out of this book as I did from the process of reaching out to others in the profession and getting such a warm response. I strongly believe that the more we share the stronger we are as a profession.

Stella Gassaway, AIGA, ACD
STELLARVISIONS | bYte a tree
www.vizbyte.com

Contents at a Glance

Chapter 1: Making The Desktop Your Own	1
Chapter 2: Organizing Your Files And Stuff	31
Chapter 3: Managing Memory	49
Chapter 4: Taming Your Fonts	69
Chapter 5: Life in the System Folder	83
Chapter 6: Optimizing Your Mac	103
Chapter 7: Choosing A Macintosh Model	135
Chapter 8: Buying, Connecting, And Using Monitors	149
Chapter 9: Keyboards, Mice, and Peripherals	173
Chapter 10: Storage	189
Chapter 11: Scanners	209
Chapter 12: Printers	221
Chapter 13: Networking and File Sharing	243
Chapter 14: Using The Internet	259
Chapter 15: Image Processing	293
Chapter 16: The Tools Of Illustration	323
Chapter 17: Desktop Publishing and Page Layout	351
Chapter 18: 3D and Animation	399
Chapter 19: Multimedia	445
Chapter 20: Business Applications	475
Chapter 21: Living In A Non-Mac World	511
Appendix: Product Guide	523
Index	535

Table of Contents

1	Making The Desktop Your Own	1
	The Desktop: More Than Meets The Eye.....	2
	Let's Define the Terms.....	3
	How the System and Finder Work Together	4
	Customizing What You See.....	7
	Setting Desktop Patterns.....	7
	Options and Ideas for Creating Desktop Patterns.....	10
	Painting and Using Filters	11
	Using Photos as Desktop Patterns.....	11
	The Impact of Changing the Desktop Pattern	11
	Changing the Appearance of Windows.....	13
	Working with the View Menu.....	13
	The Views Control Panel	14
	Working with Labels.....	15
	Creating Custom Icons.....	16
	Customizing Your Access to Data.....	20
	Launching Applications	21
	The Launcher.....	21
	Apple Menu Items.....	22
	Easy Access to Information.....	22
	The Best Organizational Tip I Know	22
	The "Recent" Apple Menu Items.....	23
	Parking Places for Information.....	24
	Customizing the Handling of Images	25
	Using the Scrapbook.....	26
	Image Viewers.....	26
	Screen Captures.....	27
	Automated Tasks and AppleScript	28
2	Organizing Your Files And Stuff	31
	Data Management in the Creative Environment.....	32
	Avoid Missing Deadlines.....	32
	Avoid Wasting Time.....	32
	Avoid a Fatal Crash.....	33

Organization.....33

- Loading Files.....33
 - Making a Disk Image.....34
 - Reading the Read Me Files.....34
 - Getting Ready to Install.....34
 - Installing.....35
- Avoiding Conflicts.....35
 - INIT and Control Panel Conflicts.....35
 - Corrupted Files and Viruses.....36
 - Outdated Applications.....37
- Finding and Making Space38
 - Storage Methods.....38
- Data Management Strategies—Setting Priorities43
 - Options for Finding and Organizing.....43
 - Putting It All Together.....45
- Summation.....47

3 Managing Memory 49

- Acronyms Abound50
- How RAM Works.....51
- RAM Basics51
 - Allocating Memory to an Application.....53
 - How Does RAM Impact Performance?56
 - Avoiding Crashes.....56
 - How Much RAM Do I Need for Specific Applications?.....57
- Types of Memory58
 - VRAM.....58
 - Cache Memory.....59
 - How Much Speed Will a Cache Card Give Me?.....60
 - PC Cards.....60
- How to Purchase Memory62
 - Begin with the Manufacturers.....63
 - What Is a Memory Broker?63
 - Catalog Houses...The Hybrids.....64
 - Finding a Good Price65
 - Basic Memory Questions to Ask66
 - Is It Composite or Non-Composite?.....66
 - What is the Refresh Rate?.....67
 - What is the Board Thickness?.....67
 - What is the Warranty and Guarantee?.....67

4	Taming Your Fonts	69
	Installing Fonts.....	70
	System 7.0 Font Installation.....	70
	System 7.1 Font Installation.....	70
	Styling Type.....	71
	Type Styles or Styled Type?.....	71
	Kerning Text.....	72
	Adjustable Fonts.....	73
	Organizing Fonts.....	74
	Font Suitcases.....	75
	Font Management Utilities	75
	Indispensable Font Utilities.....	79
	Organizing the Fonts Menu.....	79
	Printing Font Samples.....	80
	Collecting Fonts.....	80
	Fontographer.....	81
5	Life in the System Folder	83
	Extending the System.....	84
	Extensions	84
	Control Panels.....	84
	Extension Overload.....	85
	Stripping Down the System.....	86
	Isolating Extension Conflicts.....	93
	Hidden System Files—The System as a Suitcase.....	96
	Organizing System Files	99
6	Optimizing Your Mac	103
	Hardware Optimization.....	104
	Disk Performance.....	104
	Cleaning Up.....	104
	Rebuilding the Desktop.....	106
	Optimizing Existing Disks.....	107
	Hard Drive Limitations	109
	Disk Arrays	110
	RAM Performance.....	110
	RAM Speed	112
	RAM Type and Interleaving.....	114

Cleaning Up Corruption in RAM.....	115
Zapping PRAM.....	116
Hardware Accelerators.....	117
System-Wide Acceleration.....	118
Application-Specific Acceleration.....	120
Software Optimization.....	121
Faster Software	121
Native Software	121
Bloated Software, Bloated Systems.....	122
Connectix Speed Doubler.....	122
Viruses: Fact or Fiction?.....	123
Working Faster.....	125
Automating Your Work	125
Optimizing Your Work	127
Organizing Your Workspace.....	130
7 Choosing A Macintosh Model	135
Determining Need.....	136
Finding a Balance of Features	136
Microprocessor Speed.....	136
Memory Size	137
Expanding your Mac's Capabilities.....	139
Storage Space.....	139
Many Makers of Macintosh.....	142
Power Computing.....	143
DayStar's Multiprocessing Macs.....	144
Additional Considerations	147
Adding Peripherals.....	147
Built-in Features.....	147
Internal Expansion.....	148
8 Buying, Connecting, And Using Monitors	149
Sizing Advantages and Disadvantages.....	150
Secondary Monitor Considerations.....	153
Specifications.....	154
Flat-Screen Monitors.....	154
Secondary vs. Primary	155

Pitching Dots.....	155
Primary vs. Secondary Monitor	157
Refreshing Images.....	157
Primary vs. Secondary Monitor.....	157
How Big <i>is</i> That Display?	158
Primary vs. Secondary Monitor	159
Etchings and Coatings.....	160
Resolutions and PPI.....	161
Colors and Color Depth.....	163
Magnetism, Color Distortion, and Controls.....	164
Controlling the Image.....	164
Hardware	165
Colorimeters.....	167
Cards and Adapters.....	168
Cards.....	168
Adapters.....	168
Troubleshooting.....	169
Shimmies and Wiggles.....	169
Sync-on-Green.....	169
Monitor Manufacturers	170

9 Keyboards, Mice, and Peripherals 173

Communicating with Your Mac	173
Keyboards	174
Apple Standard Keyboard	175
MacAlly.....	175
Trackball Keyboards	175
Trackpad Keyboards.....	176
Curved and Ergonomic Keyboards.....	176
Variations on Keyboards.....	177
Keyboards for Fun	178
Mice.....	178
Apple and Other One-Button Mice.....	179
Optical Mice.....	179
Cordless Mice.....	179
Multi-Button Mice.....	180
Kensington.....	180
Microspeed.....	181
Logitech	181

Trackballs.....	181
Kensington	182
CH Products.....	183
Itac	183
Microspeed MacTRAC.....	183
Logitech.....	183
Trackpads.....	184
Alps, Cirque, MicroQue, and Touché Trackpads.....	184
Tablets.....	185
Wacom.....	186
Calcomp.....	186
Hitachi StudioPad.....	187
Software and Summation	188
10 Storage	189
Progress.....	189
How Big is Big Enough?.....	190
Issues to Consider.....	191
The Technology	192
Cabling.....	192
Access and Transfer Rates.....	193
Winchester.....	193
Optical Hard Drive (CD-R and MO).....	194
Tape.....	196
Removable Storage Solutions.....	196
Diskettes.....	196
Smaller Removables.....	197
Iomega Zip.....	197
SyQuest.....	199
LaCie Joule.....	200
Magneto-Optical.....	200
CD-Recordable.....	201
Jaz and SyJet	202
Iomega Jaz.....	202
SyQuest SyJet.....	203
DAT, DLT, and 8mm.....	203
DAT Tape.....	203
DLT Tape.....	204
8mm Tape	204

Fixed Storage Solutions.....	204
RAIDs.....	205
Backup Strategies.....	206
Technical Tips.....	206
Setting Internal SCSI IDs.....	206
Disk Tools.....	207
Summation	208
For More Information.....	208
11 Scanners	209
The Technology	210
Resolution.....	210
Color Depth.....	211
Dynamic Range	212
RAM	212
Slide Scanners	212
Drum Scanners.....	213
Alternative to Scanning.....	213
Market Offerings.....	214
Flatbed Scanners.....	214
Agfa.....	214
Apple	215
Epson.....	216
Hewlett-Packard.....	216
LaCie	217
Primax.....	217
Relisys	217
ScanView	217
Umax.....	218
Slide Scanners.....	218
Kodak.....	218
Minolta.....	218
Nikon Super Coolscan	219
Polaroid SprintScan.....	219
Drum Scanners.....	219
Eurocore Hi Scan.....	219
Optronics.....	220
ScanMate.....	220
Technical Issues.....	220

12 Printers	221
The Revolution.....	221
How Printers Work.....	222
Inkjet Printers	222
Laser Printers.....	223
Thermal-Wax Printers.....	223
Dye-Sublimation Printers.....	223
Imagesetters—DPI vs. LPI.....	224
Interpolation.....	224
Assessing Your Needs.....	225
Black-and-White or Low-Color Solutions.....	225
Basic Color Solutions.....	226
Professional Color Solutions.....	226
PostScript.....	226
Print Speed.....	227
Fonts	227
Connectivity.....	228
Drivers.....	228
Printers on the Market	232
Inkjets and Hot Wax.....	232
Apple StyleWriters	232
Epson Stylus Series.....	233
Hewlett-Packard.....	233
Tektronix.....	234
Lasers.....	234
Apple LaserWriter.....	234
GCC.....	235
Hewlett Packard.....	235
QMS.....	237
Tektronix.....	237
Xerox.....	237
Thermal-Wax/Dye-Sublimation Combinations.....	238
Tektronix.....	238
Fargo.....	238
Kodak.....	239
Seiko.....	240
High-End Color.....	240
Kodak.....	240
Optronics.....	240
Summation	241

13	Networking and File Sharing	243
	Networking Options.....	243
	Chooser.....	245
	Sharing Files.....	246
	Creating Users.....	249
	Creating Groups.....	250
	Restricting Access.....	251
	Macs and PCs	252
	Servers.....	253
	File Servers	253
	Email Servers.....	254
	Printer Servers.....	254
	Remote Servers Access.....	255
	Modem Servers	255
	Network Topologies.....	256
	Bus Topology.....	256
	STAR Configuration.....	256
	Network Rendering.....	258
14	Using The Internet	259
	What Is the Internet?.....	259
	What is the Web?.....	260
	What is Usenet?.....	261
	How to Surf the Net.....	263
	Hardware	263
	Choosing an ISP.....	266
	Configuring the TCP/IP and SLIP/PPP Software	267
	Using Netscape Navigator.....	267
	Plug-ins.....	270
	Search Engines and Tools.....	271
	Free Stuff for Creative Professionals.....	273
	Check Out These Fonts.....	274
	And There's Software, Too?.....	274
	Professional Development.....	275
	Drumming up Business.....	276
	Find New Clients.....	276
	Research Clients	277
	Doing Market Research.....	277
	How to Build a Web Page.....	278
	Using PageMill.....	280

Marketing Your Pages.....	281
Registering with Catalogs.....	282
Registering with What's New Lists.....	282
Other Methods	282
Converting Existing Documents to Web Format.....	282
Adobe Acrobat.....	283
Conversion Utilities.....	283
Graphics File Format Issues	284
Resolution.....	284
GIF Files.....	284
Special Flavors of GIF.....	285
JPEG Files.....	286
Transferring Files via Email and FTP.....	286
Transferring Files.....	288
15 Image Processing	293
Bitmap Basics.....	294
Resolution and File Size.....	294
The Impact of Resolution on File Size.....	295
Monitors and Resolution.....	296
Color Models Used in the Imaging Process.....	297
Other Color Models.....	297
What are the File Formats Used?.....	298
What Imaging Programs are Available.....	300
Color-It!: The Low Cost Leader.....	301
Painter: Textures and Brush Strokes.....	302
xRES: The All-Purpose Entry.....	303
Live Picture: Image Processing Powerhouse.....	305
Photoshop: Hail to the Chief.....	306
Optimizing Photoshop	308
Making Photoshop go Faster	308
RAM.....	308
Hard Drives.....	310
Exporting to the Clipboard	310
Accelerator Boards and Cache Cards.....	311
Filter and Plug-In Enhancements.....	311
Kai and Company.....	311
Convolver	312
KPT Bryce and KPT Vector.....	313
Xaos Tools.....	313

	Creative Plug-Ins From Adobe.....	314
	Utilitarian Filters.....	314
	Automating Photoshop	317
	AppleScript	317
	Photomatic.....	318
	Batch-It!.....	318
	Calibrating Color in Photoshop	319
	Gamma Control Panels.....	319
	Monitor Prefs.....	320
	Printing Inks Set-Up.....	320
16	The Tools Of Illustration	323
	Introduction: The Vector Image.....	323
	Do I Need to Know How to Draw?	325
	Dedicated Autotracing Software	325
	The Big Two: Adobe Illustrator and Macromedia FreeHand.....	328
	Let's Be Objective.....	330
	Drawing with a Bar of Soap (the Mouse and the Bézier Curve).....	331
	Adobe Illustrator: The First on the Scene	334
	Drawing Tools.....	334
	Selection Tools.....	336
	Transformation Tools.....	337
	The Paint Style Palette	338
	Plug-In Filters.....	338
	Typographic Features.....	340
	Special Type Effects.....	340
	Macromedia FreeHand: Robust Features	342
	Forget the Pen Tool—FreeHand's Better Way.....	342
	The Inspector Palette.....	344
	Drag-and-Drop Color and Other Goodies.....	346
	Great Alternatives: Deneba Canvas and CorelDRAW!.....	347
	DrawTools' Plug-Ins Add More Functionality.....	349
17	Desktop Publishing and Page Layout	351
	The Software.....	352
	The Right Package for the Job.....	356
	Books and Long Documentation	356
	"Pretty" Books.....	356
	FrameMaker for Technical Titles.....	358

Magazines and Journals.....	359
Design-Intensive Magazines.....	359
Page Layout for Journals.....	360
Newsletters and Newspapers.....	364
Marketing Materials.....	365
Making Page Layout Packages Work for You.....	367
Turbocharged Keyboard Shortcuts	367
Getting Around in Your Documents.....	374
Keeping Your Documents Consistent.....	374
Style Sheets.....	375
Master Pages.....	378
Kern and Track Your Way to Professional-Looking Type.....	378
Wrestling with Graphics	380
Graphics File Formats.....	381
Living in a Colorful World.....	382
Spot Color Systems.....	382
Color Matching and Management.....	383
Electronic Imposition.....	384
What is Imposition?.....	385
Electronic Imposition on Your Mac.....	385
Setting Up Your Files.....	386
Dealing with Foreign File Formats.....	387
Page Layout in Many Languages.....	388
Preflight: Getting Ready for Takeoff.....	390
When Bad Things Happen	393
Save, Save, Save.....	394
Overcoming Printing Problems.....	397
18 3D and Animation	399
The Software.....	400
Other Support Software	401
The “Gotta Have It” List.....	401
The “Nice To Have” List	401
Minimum Hardware Configurations.....	402
So, What is 3D?.....	403
LogoMotion.....	404
Interface.....	404
Infini-D.....	405
Interface.....	405
The World	405

Velocity Controls.....	408
Surface Composition.....	409
Boolean Functions (Operators)	410
ShadowCatchers™.....	410
Infini-D's Workshop.....	411
Using Infini-D.....	414
Depository Trust Company.....	414
Dream World Productions.....	414
Packaging and Product Design.....	415
Zima.....	415
Monster Truck	415
3D On The Mac—High End.....	416
form•Z.....	417
Why form•Z?.....	417
Interface.....	417
Surface vs. Solid Modeling.....	421
Modeling in form•Z.....	421
If You Need Help.....	427
Import/Export.....	427
ElectricImage Animation System.....	428
Features.....	429
Import, Hierarchy and Linking.....	432
Extensibility.....	433
Using form•Z and ElectricImage.....	434
The Health Rider.....	434
HORDE Concert Tour CD.....	436
Summation.....	439
Features Comparison.....	440
19 Multimedia	445
Introduction: Media on the Desktop.....	445
How Many Hats Will You Wear?	446
The Multimedia Production Process.....	448
Planning the Program.....	448
Media Creation	449
Integration and Programming.....	450
Testing and Final Delivery	451

Creating Graphics.....	451
Resolution: What You See Is All There Is	451
Color Depth: Living With a Smaller Box of Crayons.....	452
Converting a Graphic to 8 Bits.....	454
Creating Sounds.....	455
MIDI: Your Personal Orchestra	456
CD Audio.....	458
Synthesized Speech.....	458
Digital Audio: The Ultimate Tape Recorder	459
Using Video.....	464
Video Compression.....	465
Spatial Compression.....	467
Temporal Compression.....	467
Creating Animation.....	469
Integration: Putting it Together.....	469
Special Deliveries: CD-ROM, Disk, Web.....	471
Summation.....	474
20 Business Applications	475
Business Basics.....	476
Word Processors.....	477
Word	477
Nisus Writer.....	478
WordPerfect.....	478
ClarisWorks	481
WriteNow 4.0.....	482
Letters and Other Good Words.....	482
The Envelope, Please... ..	483
Merge Right... ..	484
Whatever Works... ..	487
Microsoft Office.....	488
The Fax of Life.....	489
Accounting for the Mathematically Challenged.....	492
Things to Consider When You Choose an Accounting Program.....	493
Keeping Time.....	494
Paperwork Made Simple.....	496
Bank by Modem?	498

Getting Organized	500
Putting on a Good Show	503
Other Helpers.....	507
When Your Shipping Comes In... ..	508
Number, Please... ..	508
Paper Goods and Goodies.....	509
Ergonomics	509
Summation.....	510
21 Living In A Non-Mac World	511
Getting There Is Half the Fun?.....	512
Crossing Platforms Without Getting Clobbered	515
Can a Mac Do Windows?.....	517
Into the Great Unknown.....	519
Sharing Our Toys.....	521
Summation	522
Appendix Product Guide	523
Index	535

1

Making The Desktop Your Own

Customizing your Macintosh for the way you work may be one of the most overlooked tasks in Macintosh computing. It seems that some people lose interest in learning what the Mac OS can do, after they know how to point the mouse and double-click. In their rush to pick out what they think is more important information, many people will pass over this chapter in their first pass at this book. Hopefully, they will stumble back to it at some point, and gain an appreciation of how important it is to customize their Macintosh for the way they work.

Many people ignore the subtle power of the Mac's System/Finder, because they are in a rush to get things done, and wrongfully assume that the applications are the only things they should be spending time learning in detail. Applications, such as Photoshop and Quark, are indeed the powertools in the graphics workshop, but it is just as important to give at least a little thought to how you, quickly and efficiently, sweep the floor and clean the mess caused by all the other tools.

Other people may have learned some Mac customization back in the System 6.8 or 7.0 days, and assume that they are up-to-date with things. They are

If you want to know... Go to...

How can I add to my desktop patterns collection?	8
What are aliases?	21
How do I add items to my Apple menu?	22
Can I change the color of labels?	16
How do I calculate folder sizes in windows?	15
Can I use photographs as desktop patterns?	11
How can I create more visually interesting icons?	16

experienced Mac users who have a good foundation in basic Macintosh operation. The reality, however, may be that they are unfamiliar with many of the new features in the most recent System revisions, some of which could make their life a lot easier. Some of them may even equate customization with cosmetic indulgence, saying they are too busy to worry about their desktop pattern, or whether their system font is 10 or 12 point.

This chapter asks everyone to take a few minutes to focus on the Macintosh System itself and seriously consider how it impacts workflow, productivity, and general state of mind. Take and apply what's relevant to the way you work, and leave the rest behind.

"I've always felt like I've started this job too late. Reading has helped allay my fears and inform my decisions."

Benno Schmidt, AIGA
Design And Research
Washington, DC

The Desktop: More Than Meets The Eye

When the Macintosh was released in 1984, the thing that made it significantly different from any other computer on the market was its Operating System, along with its Graphical User Interface (also called a GUI, or "Gooney"). These components manifested themselves most clearly in what the Apple people called the desktop. In addition to it being graphical and image-based, the desktop also was customizable. This meant that the desktop wasn't just Apple's, but that it belonged to all of us; that you could tweak it to your own liking. At a time when computers were perceived as formidable opponents rather than digital allies, the fact that users had even a little control in the process went a long way toward Apple's success.

Looking back over the past 12 years, it appears that the rest of the computing world has recognized the importance of a customizable desktop and interface. Windows, HP, SGI, and many others have released their own versions of the Macintosh Operating System, in an effort to give the public what it wants. Considering that you're reading a book called *The Whole Mac*, I will assume that you feel as I do, that the Mac still has the most intuitive and responsive interface available today. This chapter looks at the many ways users can control their interaction with the computer, making the Mac experience more productive, intuitive, and yes, more fun.

The Mac OS: Compliments Of Xerox

The Mac OS is unique. It's superior to other operating systems, and it was revolutionary when it was released in 1984, but what many people don't know is that much of the technology behind Apple's OS revolution did not originate inside Apple. Instead, it was developed inside one of the most advanced technological think tanks of its day.

The Xerox Palo Alto Research Center, also known as Xerox PARC, was founded in 1970 in Palo Alto, California. It was set up as a progressive technology center where the most creative minds of their day could work on new technologies unencumbered by the commercial restraints and timelines involved in bringing a product to market. Xerox wanted to be at the forefront of technology, and although their engineers achieved an impressive array of computer industry firsts, most of these were marketed by companies other than Xerox.

One result of this environment was a computer system called the Xerox Alto, arguably the first personal computer. The Alto was the first machine to use bit-mapped graphics that controlled screen items at the pixel level, rather than through preformatted characters. The Xerox PARC people created a little networking protocol called Ethernet, which enabled multiple Altos to share data, as well as printing functions. For printing, the Alto utilized another PARC creation: the laser printer. (Keep in mind, the time is 1973, and the world is full of mainframe propeller heads and a host of designers cutting rubyliths at drafting tables.) The Alto had a graphically based programming language called SmallTalk that ran reusable scripts of code to perform functions. Check out the definition of the Macintosh ROM in the next section and see if this rings any bells.

The Alto was well known in most computing circles in the Silicon Valley, and it was certainly known to the engineering people at Apple. In one of his most significant acts as Apple's CEO, Steve Jobs was able to gain access for himself and some of his engineers to take a firsthand look at this breakthrough technology. The Xerox Alto served as the inspiration for what the Apple engineers were to create; first as the ill-fated Lisa, and ultimately in 1984 as the very customizable Apple Macintosh.

Let's Define the Terms

The way I'm throwing terms around like desktop, operating system, GUI, and the like, you might get the impression that they are interchangeable, and that they all mean the same thing. This is not exactly true. Each is a component that defines how you interact with the data in your system, often playing its own individual role. Listed below is a short definition of the components to be mentioned in this chapter.

- Control Panel—Also known as a Desk Accessory, or DA. Used to control certain system parameters, such as the System Clock, Monitor Colors, and Networking options.
- Desktop—The on-screen work area of a computer, where icons and symbols represent features of an actual desktop.
- Extensions—An extension is a file that adds functionality to the Macintosh Operating System. Extensions often facilitate the addition of third-party products, such as modems or printers, letting the

system know their characteristics. Optional Apple features, such as AppleScript and QuickTime, are supported through extensions.

- Finder—Unique to the Macintosh, the Finder is a separate file that interprets the Apple Operating System in graphical terms. It is the Finder that gives the Apple Desktop its graphical appearance and separates it from text-based interfaces, such as DOS.
- Graphical User Interface (GUI)—A type of display format that enables the user to view data and execute commands in graphical terms. The Macintosh Finder is a specific type of GUI.
- Macintosh ROM—A small integrated circuit chip that contains the core set of instructions and routines that make the Macintosh act like a Macintosh. The system and Finder software act only to support and enhance the ROM's functionality.
- Macintosh Toolbox—A specific portion of the Macintosh ROM that contains scripts or routines, called Managers. These Managers control specific functionality in the OS, such as pulling down menus, or saving and opening files.
- Operating System (System or OS)—The Operating System is command central for the computer, controlling the allocation of CPU resources, such as memory and drive usage, processor activity, and peripheral device control. When the Mac OS is mentioned here, it refers to the combination of ROM, Toolbox, Finder, and other elements that work together to orchestrate how the Mac stores and accesses data.
- System File—The file in the Macintosh that controls various resources and characteristics of the Mac OS. These resources include fonts, sounds, and language characteristics.
- System Folder—The System Folder is a general storage folder, containing most items that affect the functionality of the Macintosh. It includes such items as: control panels, Apple Menu Items, extensions, and preferences.

How the System and Finder Work Together

The Macintosh is unique in that the tasks performed by the operating system do not originate in the System File itself. There is no point in the CPU that can be singled out as the “Operating System.” Instead, the functionality is an orchestrated effort involving the Macintosh ROM, the Macintosh Toolbox, the system, Finder, and a host of extensions and control panels.

At the heart of the system is the Macintosh ROM, a portion of which is called the Toolbox. The Macintosh Toolbox contains individual scripts, called Managers, that determine how the Macintosh responds to specific tasks. Pull down a menu, and the Menu Manager script says, “make it so.” The QuickDraw script determines how all graphics are rendered on the

Mac, and the Font Manager controls the various behaviors of type. Other Managers control the behaviors of windows, Events updates, and resources.

The engine that coordinates the various Toolbox Managers also resides in ROM. This engine is what most people think of when they refer to the Mac OS. The Toolbox Managers make calls to the OS, telling it to interact with the Mac in various ways, such as saving a file, or printing a letter. All Macintosh applications use the exact same Toolbox Managers to design their interfaces and execute commands. This is why the Mac has maintained a consistent look and feel regardless of what version of what program you are using.

If most of the hard stuff is being done in the Macintosh ROM, what is the System File actually doing? Residing in your System Folder, the System File controls various resources, such as sounds, system fonts, icons, and cursors. It interacts with the Resource Manager in the Mac ROM to execute these various functions. The System File acts as a conduit to the core functionality of the ROM, enabling certain modifications within a very tightly controlled set of parameters. Control panels and extensions make modifications to the functionality of the Mac through the System File, directly to the ROM.

All of which brings us to the Finder. The Finder is perhaps the most misunderstood component of the Mac OS, especially considering that it is not part of the OS at all. The Finder is actually an application that is launched at startup, from which the user cannot quit. If there were no Finder, the Mac would look like a DOS machine, displaying an antiseptic, blinking cursor to the right of a sterile C prompt.

It originally was called the Finder because its job was to go out and find files. In addition to finding files, the Finder's tasks include launching applications, renaming files, and creating aliases. The Finder accomplishes most of its tasks with the help of an invisible file called the Desktop file. The Desktop file tells the Finder where every single file is on every disk, diskette, or cartridge. It does this via a table that tracks the file's name as well as its location. The Finder then reports the information back to the user through the icons and information on the desktop.

Everyone is talking about the role that intelligent agents are going to play in helping us navigate the Internet. These set top boxes/programs/PDAs are going to go out over the Net and sift through miles of information, presenting us with the results in an accessible, convenient format. In many ways, the Apple's Finder has been performing a similar role since 1984. The difference is that instead of monitoring the Internet as an agent would, the Macintosh Finder monitors the Mac OS elements. It does not control anything directly. It doesn't control the file lookup table like the Desktop file, or the opening of a menu like the Menu Manager in the Mac ROM. Instead, it merely monitors all these functions, and reports everything back to you in a convenient, easy-to-understand format.

I have been a graphic designer for 10 years now and have really watched the computer industry grow. I just hope I'm keeping up.

Carolyn Cobb
Office of the V.P. of Research
and Assoc. Provost Grad.
Studies
Texas A&M University

Copland Is Coming...Eventually

The next major revision to the Macintosh Operating System is System 8, which Apple has christened with the development name Copland. Copland promises to take Apple's core philosophy of making computers more intuitive and easier to navigate to a higher level. Their goal is to make a person using Copland more productive than is possible with any other system.

Copland will deliver system enhancements on three levels:

- It will enhance the human interface in the system.
- It will deliver faster performance on Power Macs by fully exploiting the power of RISC processing.
- It will deliver new technologies to make document interchange and Internet access even easier.

From a customization point of view, Copland will enable users to scale the interface to match their skill levels and requirements. This means certain menus and options can be added or deleted in order to streamline or enhance the desktop's functionality. It also will include a new set of metaphors for searching for files, making it even easier to access information.

Rounding out Copland's customization features will be enhanced built-in assistance, where the computer does more of the work in performing more tedious or difficult tasks. In addition to Copland's capability to automate certain functions, it will offer enhanced user support, building on the capabilities first introduced in the Apple Guide component of the system.

Because it is still in development, it is impossible to give more specifics on exactly what features will be in the shipping product. Apple has expressed its desire to have it work on a standard 8MB Macintosh, requiring at least 50MB of free disk space. Given most designers' propensity for cramming fonts, clip art, and other necessities onto their machines, the 50MB disk space requirement could be a killer for some people.



Figure 1.1
Mac OS

Ratings



Customizing What You See

This section outlines the various ways you can control the size, shape, and color of the backgrounds, folders, and icons on the screen. Because the Macintosh has always been embraced by designers as a graphically based machine, the capability to customize it has always been important. Creative people choose the Mac because it mimicks the visual way their brains process information. Although the Mac gives us a great many options as to how you visually organize information, it is up to you to implement a system that works for you. What follows are not rules or requirements, merely options and suggestions.

Setting Desktop Patterns

Inside the Control Panels folder in the System Folder you will find a control panel called Desktop Patterns (see Figure 1.2). This is an easy-to-use panel that lets you change the background pattern on the desktop. Double-click to open it and click the right/left scrollbar arrows on the bottom to select the pattern options. When you find one you like, click the Set Desktop Pattern button, or double-click the pattern itself, to change the pattern on your desktop.

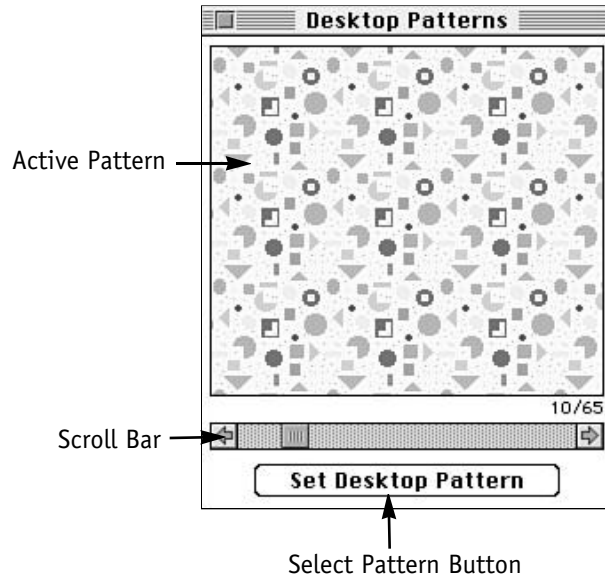

Figure 1.2
The Desktop Patterns control panel.

The Desktop Patterns control panel actually stores tiles that are repeated over a grid to make up the pattern on your screen. Most of these tiles are 64 pixels square, although it does accommodate grids up to 128 pixels.

The following shows you how to access the grids used by the Desktop Patterns control panel to create your own custom desktop designs.

- 1 With the Desktop Patterns control panel open, use the left/right scroll bar arrows to select the Teddy Bears pattern (number 61) (see Figure 1.3). This is the only 128 pixel tile in the library, giving us the biggest canvas possible.

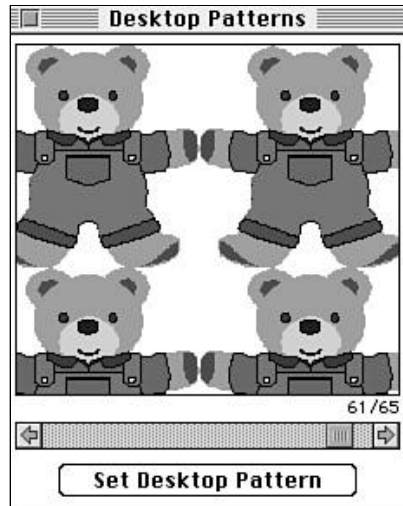
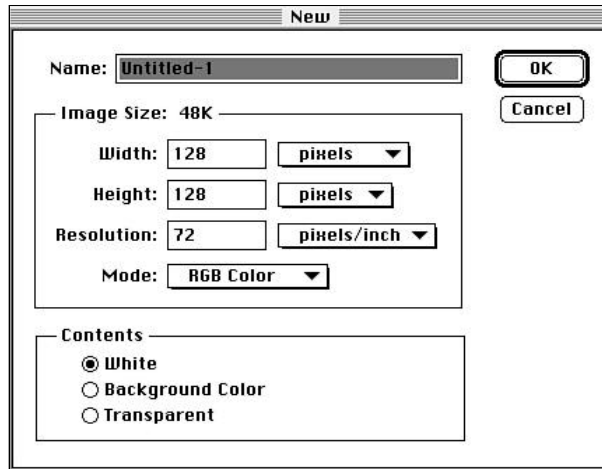
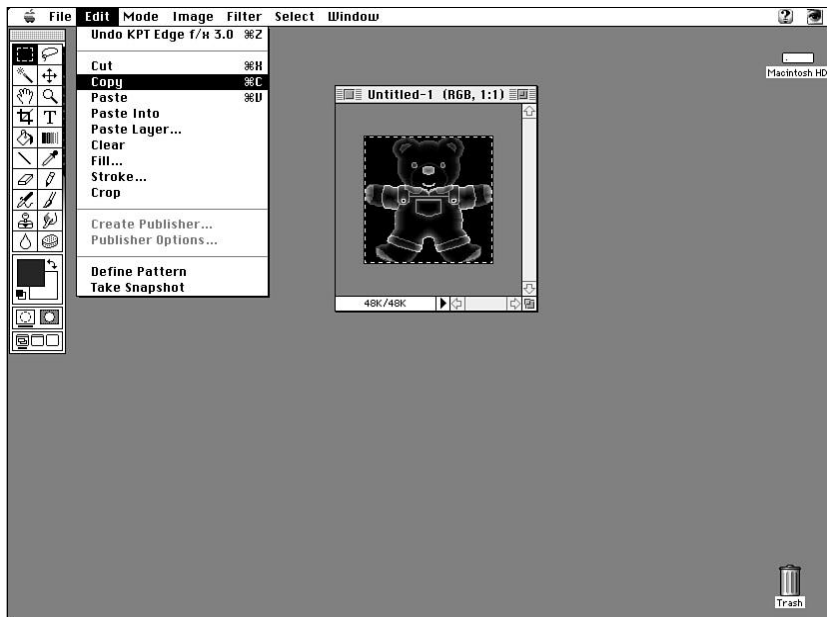

Figure 1.3
Select the Teddy Bear pattern.

- 2 Choose Copy from the Edit menu.
- 3 Open Adobe Photoshop, or some other image-editing application.
- 4 Select New from the File menu. In Photoshop, the size and resolution for the new file are displayed in a window called New. When you create a new Photoshop file while there is an image in the Clipboard, Photoshop automatically sets the size of the new file to match the Clipboard contents. You can see from the results that the New window is displaying the size and resolution of the Desktop Patterns image you copied from the Clipboard, and that is 128×128 pixels, at 72 dots per inch (see Figure 1.4).
- 5 Click OK to create a new file.
- 6 Paste the Desktop Patterns file you copied from the control panel into the Photoshop file.
- 7 Use Photoshop's paint and draw tools to modify or completely redesign the pattern (see Figure 1.5). When you are finished, select the entire tile, and choose Copy from the Edit menu.
- 8 Reactivate the Desktop Patterns control panel and select Paste from the Edit menu to paste the Photoshop file you just copied.

**Figure 1.4**

The new Photoshop window shows the dimensions of the image copied to the Clipboard.

**Figure 1.5**

Redesign the pattern in Photoshop.

- 9 Click the Set Desktop Pattern button in the Desktop Pattern control panel to view your results (see Figure 1.6).

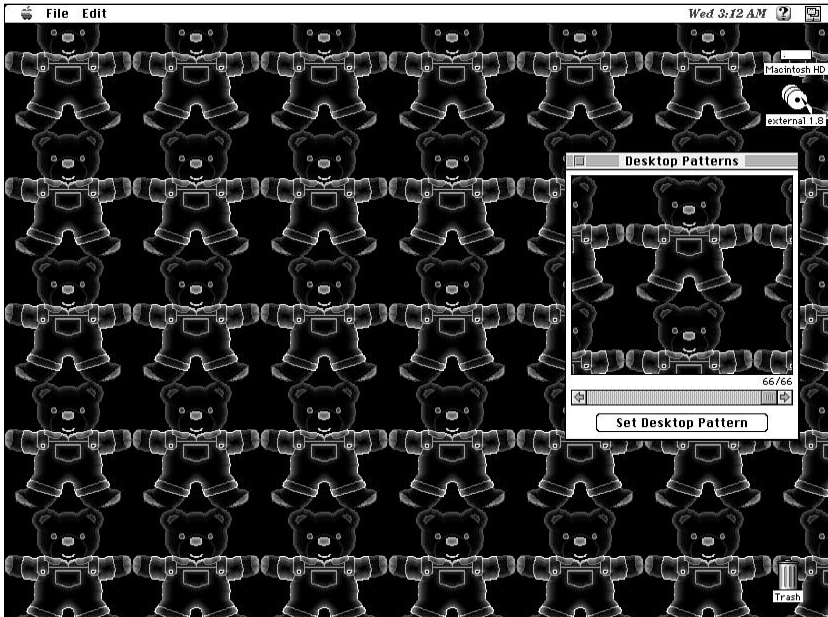

Figure 1.6
The new desktop image

Each time a tile is pasted into the tile library, it is inserted at the end of the library. If you change your mind about tiles you've pasted, scroll to that tile, and select Cut (⌘-X) from the Edit menu to remove it. Delete the Desktop Pattern tiles you will never use in order to save space and make your tile library more concise. For example, if you're just not the teddy bear and kitty type, or have added your own tiles of which you are now tired, simply select Cut (⌘-X) from the Edit menu to remove them. Not only is it easier to manage the tiles you want, you free around 12KB of disk space for each tile removed.

If you decide to make your own tiles from scratch, be sure to make the design perfectly square. The Desktop Patterns control panel automatically scales a design into a square regardless of its proportions, stretching a rectangle up to fill the space.

TIP

Selecting a pattern from the Desktop Patterns control panel while holding down the Option key applies that pattern to the Mac utilities, such as the Find File window and the Calculator.

Options and Ideas for Creating Desktop Patterns

Following the basic procedure outlined previously, a wide variety of desktop tiles can be created. Following, are listed some ideas for you to explore on your own, should you be so inclined. The results can be impressive and uniquely yours.

Painting and Using Filters

Use gradient or paint tools in Photoshop to create fills and strokes to be copied. Try adding texture to the tile using Photoshop's Noise filters, or a third-party filter, such as KPT's hue protected noise. Other filters produce impressive results as they smear, smudge, and twirl the tile image.

An alternative to starting from scratch is simply modifying the tile using a texture generator, such as KPT Texture Explorer, Adobe's Texture Maker, or Xaos Tool's Terrazzo. In this way, you can simply scroll through or generate a wide variety of examples and choose the ones you like.

After a tile is starting to look good, you can make it seamless by using the KPT Seamless Welder Filter. This is less effective for photographic images and recognizable shapes, but it works wonders on textures and patterns.

Using Photos as Desktop Patterns

The first inclination most people have when modifying a desktop pattern is trying to turn images into tiles. The biggest problem here is that many images do not translate down to a 128 pixel grid very well. The following suggestions will help make your image much more readable, and perhaps a bit more interesting:

Before you reduce the photo to 128 pixels (or smaller):

- Create stark contrasts between lights and darks using Photoshop's Curves or Levels command. This makes it easier for Photoshop to interpolate the image as the number of pixels shrinks. The result is an image that is less muddy, with more form and definition.
- Run an Unsharp Mask or a Sharpen Edges filter. This also helps retain image definition as the image is reduced.
- Convert the image to Indexed Color.

After you've reduced the image:

- Try converting the image to a duo-tone or tri-tone for some interesting effects.
- Try running the image in grayscale, while stretching the tonal values even further.
- Blur the image, while compressing the values, making for a subtle, less intrusive pattern.

The Impact of Changing the Desktop Pattern

In the movie "Jurassic Park," Jeff Goldblum's character, a physicist specializing in Chaos theory, has a line that seems appropriate about now. In trying to convey that the scientists might have opened some sort of Pandora's box by cloning the dinosaurs, he states something to the effect that the scientists spent so much time trying to see if they *could* clone the dinosaurs, that they didn't stop to think about whether they *should*. So it

goes with desktop patterns. Although it is nice to have your own personal image gallery beaming from your monitor each day, you really need to think about whether it interferes with the work you are doing. As an example, if you put up a busy, distracting pattern like the teddy bears or the computer circuit board, and then open a Word document that describes a complex issue, chances are that you will have a hard time following the text. Desktop patterns can be distracting and hinder concentration, so be careful how you use them.

Complex patterns are not the only things that distract. Although kinetic distractions are quite obvious, the distortions caused by color are equally if not more problematic. With his paintings and writings, Yale Art Professor Josef Albers generated widespread awareness of how adjacent colors affect each other. The same red swatch of color can appear different depending on the background color against which it is viewed. This creates problems in color correcting images. The problems compound themselves given that you are working in an additive color model, and the color calibration between programs, monitors, and printers is tenuous at best.

Because of this, you should keep the following points in mind as you set up your desktop patterns:

- When high concentration is required, the desktop should be unobtrusive, fading into the background.
- When viewing photographs, set your screen to a 50 percent neutral gray.
- If the images or photos you are viewing are to be printed against a specific color background, create a background tile that emulates the printed background color. (A Colortron color calibrator is great for this.)
- If the images are to be printed on a specific texture or stock, try scanning it and using that as a desktop pattern.
- When doing layout, you might find it helpful to create a tile with a crosshairs line drawn through it in a similar color. When loaded into the Desktop Patterns control panel, it will produce a soft grid that some find helpful in aligning objects, as well as organizing windows and icons.

There is no single background tile that fits every situation. If you have a library of a few backgrounds you like, you can access them at any time, changing on the fly as the situation calls for it.

TIP

You also can change the image in the Jigsaw Puzzle by simply activating the puzzle, and pasting from the Clipboard. If you use a large image, be sure to boost the memory allocated to the Jigsaw Puzzle application.

Changing the Appearance of Windows

Everything you look at on your Macintosh is in a window. Whether it is a word processing document, a Photoshop image, or the main window of your hard drive, windows are the constant container for the data on the Mac. Given this fact, some thought should be taken as to how data is viewed in the windows. There are few options in the application windows themselves, so I will focus here on how the Finder manages views.

Working with the View Menu

The Mac offers six options, all of which are displayed in the View menu of the Finder. Each Finder window has its own view setting, which allows you to customize each window based on its contents. The View options are briefly described as follows:

- By Small Icon**—This Icon-based view shows a small icon of the file or folder, including its name and label color. This is effective when you want to view several items in a small window, although it is not much help when searching for specific files.
- By Icon**—This Icon-based view shows a large icon of the file or folder, including its name and label color. Disk information, including available space is shown at the top of the window. This is effective when you want to quickly view and select from a few icons.
- By Name**—This text-based view gives the most detailed general information, listing files alphabetically, showing the size, kind, label, and date (see Figure 1.7). When looking in a cluttered window, such as the Control Panels folder or the Extensions folder, the Names view can be very helpful in locating a specific file.
- By Size**—By default, this text-based view lists each item from the largest to the smallest. When your drive is too full, and you need to remove something, this view helps you decide what items are hogging your disk space.
- By Kind**—If you're looking for a file, and you can't think of the name, but you know it was done in Word, this text-based view might help. It lists all files alphabetically, grouped by the application that created them. This is not the most popular view in the world, but hey, if it helps you, use it.
- By Label**—This text-based view groups files based on their label assignments, in alphabetical order. (Labels are explained on the following pages, and in the next chapter.)
- By Date**—You just created a file 10 minutes ago and now you can't find it, because you've forgotten its name. This text-based view helps in that situation, because it lists files and folders chronologically, with the most recent at the top of the window.

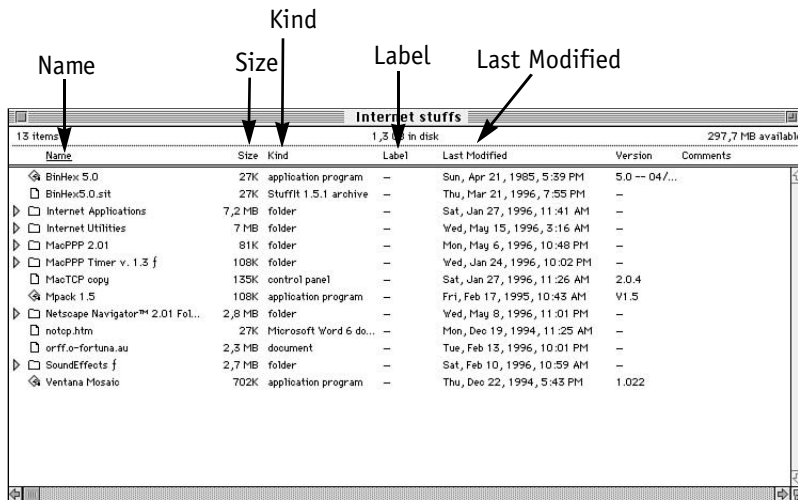

Figure 1.7

Text-based View options provide detailed file information.

The Views Control Panel

The Views control panel further controls how information is displayed in windows. Using it you can control your display font, how icons align in windows, and various information in the names type listings.

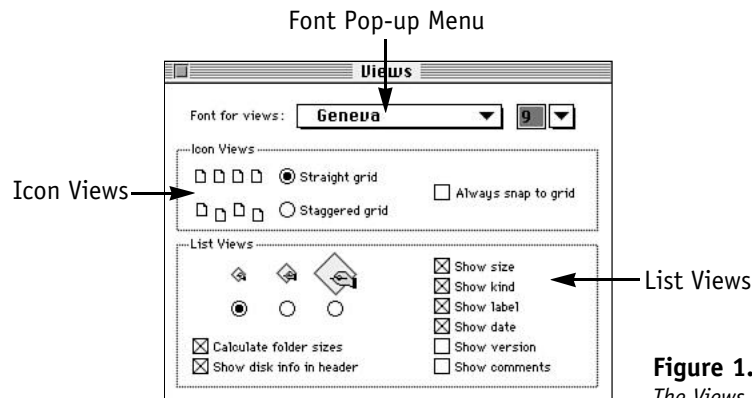

Figure 1.8

The Views control panel

The first thing you notice is that you can select a font for your windows. This selection is applied to all your windows. It changes the font used in naming files and in window headings. Although it is interesting to change the font and see something different, some general rules of thumb apply. Place readability above aesthetics. Select one that you can stand to look at for 8+ hours a day.

The Icon Views section determines whether icons align to a staggered or straight grid. This decision is most often noticed when the Clean Up Window command is selected from the Finder's Special menu.

The List Views section enables the most significant customization. There are three parts to this section.

The Icon Size Radio Buttons

If you like the large icon sizes in the By Icon View in the Views menu, but wish you could see the information shown in the By Names View, the Icon Size radio buttons will solve your dilemma. Selecting the small, medium, or large buttons will increase icon sizes in any of the text-based view options. This means that you can locate visually the file you want, and then view its size or date created.

The right setting is determined by the number of objects in a window, as large icons and lots of files tend to require excessive scrolling. When using custom icons, the large view is almost a requisite. The medium view is good for labels, but it is hard to see much custom icon detail in the medium view. Small is best if color and visuals are not being used, and you are just reading text.

Two Size Options Worth Considering

There are two small check boxes in the lower left corner of the Views control panel. One is called Calculate Folder Sizes and the other Show Disk Info In Header. I always was frustrated when I selected By Size from the View menu, because it didn't show the cumulative size of folders. Checking Calculate Folder Sizes forces the Mac to calculate the size of each folder in the window. Given that this view is used most often when trying to free disk space, checking this option enables greater control over disk and file management.

In a similar vein, disk info refers to the number of items, available disk space, and disk space used on the hard drive as a whole. It always has been helpful to see this in the Icon-based views, and I always wished I could see it in the By Names or By Size views. Clicking the Show Disk Info In Header check box displays all the disk info, even in the text-based views.

Text-Based Detail Options

The six check boxes at the far right of the Views control panel define which file and folder details are displayed in windows. If, for example, you don't use labels, shut this option off. Most of this information is pretty helpful, but use your discretion as to what is important to you.

You also should think about how you might use the Show Comments check box. Checking this box displays the comments from the Get Info comments section. You could create a system wherein you might make notes on a particular file, and view the notes at any time from any window. Remember that you can make comments for folders as well.

Working with Labels

The basic idea behind using labels is that you can highlight an icon and apply a colored label to it. The problem is that Apple also assigns a comment to each color. The words Essential, Cool, or Project 1 don't mean much to most people. But whenever you assign a label, the word "Hot,"

“Personal,” or whichever label you choose appears in the comments section of the file window. Also, Apple’s colorblind selection of ugly colors, such as hot magenta and lifeless orange, create problems for anyone with even a remote sense of color.

You can use labels to make a file stand out in a crowd of uncolored labels or to signify types of files, such as applications, job types, and other classifiable things. The only problem is the ugly colors and the dopey text. If ever an Apple option called out for customization, it’s the Labels option, and it comes with all the customization you could want (see Figure 1.9).

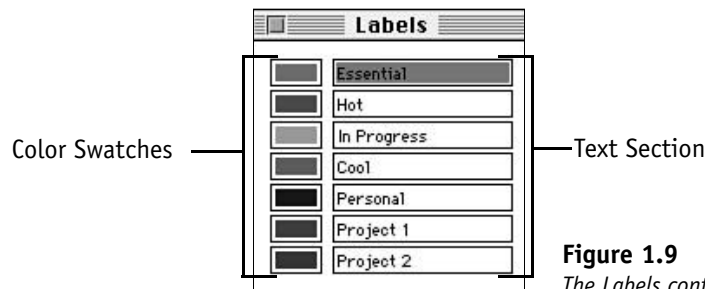

Figure 1.9

The Labels control panel

The Labels control panel is quite a simple one, with a basic table displaying the text and adjoining color. Click the text to highlight it, and type whatever text label you want. In addition, if you click the color swatch, a color picker appears enabling you to change the color.

Creating Custom Icons

One of the biggest problems with finding things on the Mac is that all the icons look the same. The same gray folder could contain the prefs file for an old version of Photoshop 1.0, or it could hold a client’s presentation. Labels change that to some extent, but they only offer six levels of variation, which isn’t much considering today’s big drives. Sure the names will be different, but when you’re looking through your multi-gigabyte haystack of a hard drive, that needle of a file name can be pretty hard to find. Given that most designers are visual people, it stands to reason that they should be able to create icons that give more visual clues as to a file or folder’s contents.

A simple and practical solution is to create custom icons for a folder or file. This procedure is similar to the one you used to create a custom background.

- 1 Open a window containing a folder, and select the By Icon View from the View menu in the Finder.
- 2 Highlight a folder icon, and select Get Info from the File menu (or press ⌘-I).
- 3 In the Get Info box, click the folder icon in the upper left corner. A box appears around it to tell you it is selected (see Figure 1.10).



Figure 1.10
Selecting a file's icon in
the Get Info window.

- 4 Select Copy from the Edit menu in the Finder.
- 5 Open Photoshop and select New from the File menu.
- 6 Click OK in the Photoshop new file dialog without changing any settings.
- 7 Paste the image into the new Photoshop file and modify as desired (see Figure 1.11).

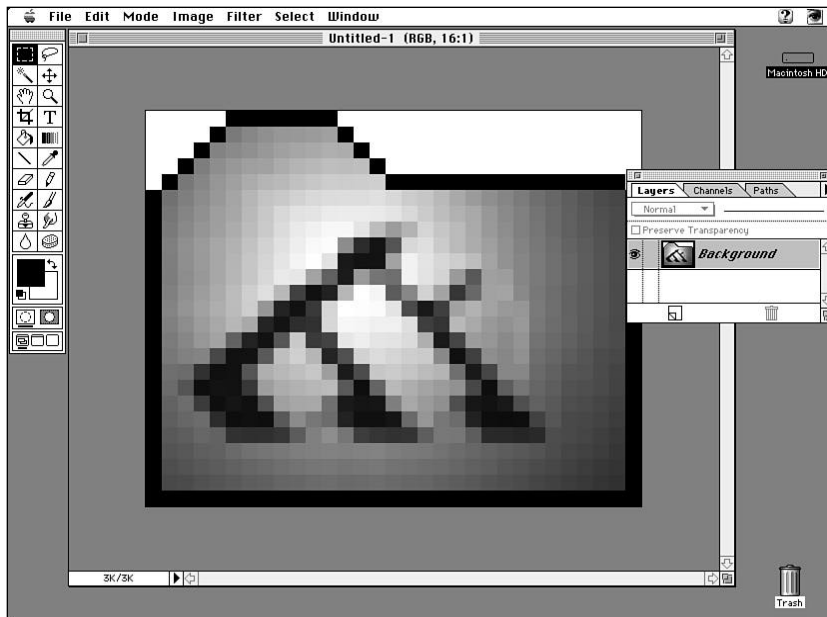

Figure 1.11
Modifying the icon in Photoshop.

- 8 When the icon looks the way you want, select the whole image by dragging a marquee around it and copy it.
- 9 Return to the Finder, select the icon that you want to change, and hit $\text{⌘}+\text{I}$ to activate the Get Info box.

- 10 In the Get Info box, click the icon in the upper left corner, and paste in the new image (see Figure 1.12).



Figure 1.12
Paste the new icon back into the Get Info box.

This procedure specifically deals with modifying an existing folder, but you can just as easily start with any image, or just go from scratch. Although the Mac will scale any image to fit the window, the actual image size is 32 pixels square. For best results, you should design with that dimension in mind.

There are, of course, other ways you can create icons. Folder Icon Maker by Gregory Robbins and iContraption by imMedia are just a couple of shareware programs that enable you to customize icons.

You also can customize icons (as well as a whole lot more that is beyond the scope of this book) with ResEdit.

- 1 Open ResEdit.
- 2 Chose New from the File menu.
- 3 Name your new file.
- 4 Under the Resource menu choose Create New Resource (⌘+K).
- 5 In the Select New Type box, choose cicon as shown in the figure.
- 6 Create the icon.
- 7 While you are still in the cicon ID box, choose Select All from the Edit menu and then choose Copy from the Edit menu.
- 8 From here, follow the ordinary procedure for changing a file's or folder's icon. Choose Get Info and paste your new icon into the old one's place.

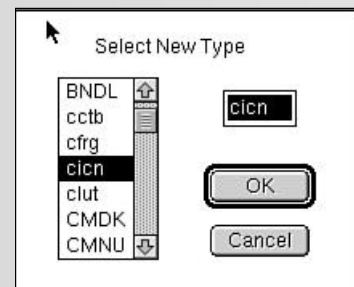

Figure 1.13

Ideas for Icon Designs

Listed below are various approaches to designing custom icons. You'll have to excuse the last few...I got onto a bit of a roll.

- Add a logo or image to a folder icon.
- Add some perspective to the folder using Photoshop's Distort command (Image/Effects/Distort).
- Create a folder icon that's open, revealing an image that reflects its contents.
- Apply a texture to a folder using various filters and plug-ins.
- Make a clouds folder using the Photoshop Clouds filter.
- Apply the KPT page curl filter to the icon, revealing a design inside.
- Lens flares on solid color backgrounds are very nice.
- Work with lighting effects, perhaps on a larger image, and then scale it down.
- Use a client's photograph in place of a folder.
- Use an image or component of a job on its folder.
- Apply the same pattern to an icon that is on the desktop, then drag the icon onto the desktop, losing the image.
- Create an icon that is a hole of some sort filled with the desktop color. Set it up so that it appears that there is a hole in your window, letting the desktop show through from underneath.

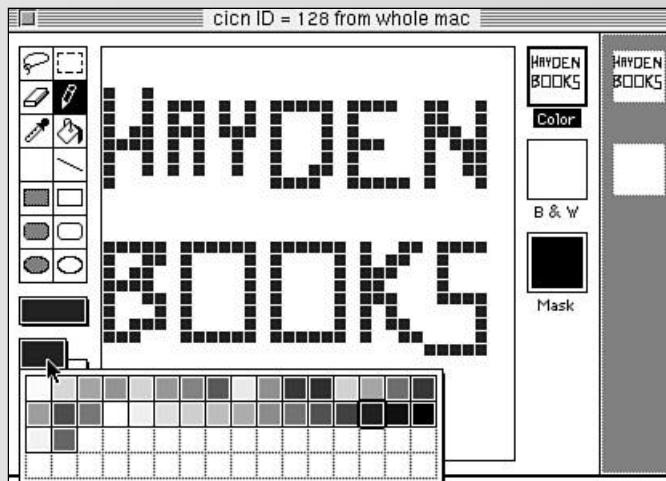

Figure 1.14

For more information on ResEdit, check out *Zen and the Art of Resource Editing* published by Hayden Books.

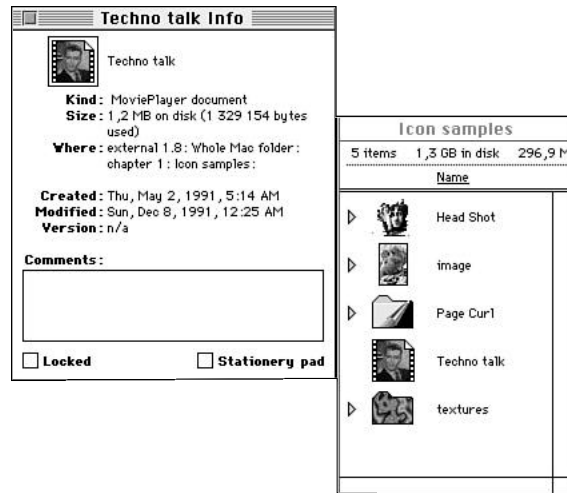

Figure 1.15
Examples of custom icon designs

Customizing Your Access to Data

Navigating through folders and windows on the Mac to locate a particular file, control panel, or buried folder can be time-consuming and confusing. Say you are in Photoshop and you want to launch the Monitors control panel to reset your screen depth. You normally would have to click back to the Finder, double-click the hard drive icon, go to the System Folder, open the Control Panels folder, and then open the Monitors control panel. After you make the change, you then are faced with four open windows cluttering the screen, which you then have to close. Wouldn't it be great to just snap your fingers and have the Monitors panel appear on-screen without all the stuff in between? That's what this section will show you...shortcuts.

All that's required is that you know where the file is, and these tips can help you get there quicker. This is significant considering the various tips outlined in this chapter, because not all modifications apply to all situations and should be chosen based on the task at hand. If you are forced to wade through loads of folders and windows to change between one option and another, you're most likely going to choose the least obtrusive combination of settings and leave it at that.

The tips in this section show you how to slip easily from one part of your system to another, without going through all the stuff in between. Some are the equivalent of taking the bus, some are like driving your own car, and others emulate the transporter on the Starship Enterprise.

As "traditional" graphics designers, we were dragged into the computer age kicking and screaming, skeptical of the value of the Mac to our business. Now, years later, we are firmly convinced of the choices it presents us, and the fabulous new tools at our disposal, and we wouldn't do without it.

That said, we're amazed and impressed with the degree of CONTROL it affords us over even the most complicated of tasks, and disappointed when we see the Mac used as a crutch to hide a basic lack of design sense. A canvas does not a Picasso make; it is the hand that holds the brush. And, as much as we enjoy, appreciate, and depend on the Mac, we regret that fact is lost on many people outside our profession.

Bill Wilson
Wilson-Lewis-Wilson Design
Palm Harbor, Florida

An Alias By Any Other Name...

An easy and basic shortcut for getting to a file is by using an alias to launch a folder or file. An alias is like a remote activator that goes straight to the original object, and opens it. Think of it as a digital garage door opener. While you sit in your car and click a button, the remote device opens the car door, tromps through the snow, and lifts open that heavy door for you...(or at least opens Live Picture).

The cool thing about aliases is that you can have an unlimited number of them. This means that you could create ten aliases for Quark and place one in each of your job folders. An alias for the Monitors control panel would save you from weeding through several folders to get where you need to go.

Aliases are controlled by a Manager within the Toolbox whose only job is to correlate between an alias and an original file. Although the alias can be placed anywhere, the original does need to stay where it is. If you move it, the Alias Manager gets confused and refuses to work any longer.

Launching Applications

You update an image in Photoshop, and you want to see how it looks with the PostScript Illustrator graphics you've put around it. You need to go to Illustrator and view it there, and then launch Quark to view the entire spread with the changes. Design work necessitates bouncing back and forth between multiple applications, without losing focus on the task at hand. There are various ways to launch an application from a distance. Some are more practical than others, depending on the way you work.

The Launcher

The Launcher is a special type of window with big icon buttons. It usually is set to appear automatically at startup, offering a direct choice for what to do next. The Launcher works pretty well at startup, but I find that the window gets in my way as I try to work and I always end up closing it. This defeats the purpose, because then I have to dig back into a folder to open the Launcher window. I might as well just dig into a folder and launch the application. If you don't mind the window on your desktop, however, the Launcher can be convenient (see Figure 1.16). To add an item to the Launcher window, create an alias of the item and drag it to the Launcher Items folder, which is in your System Folder.

NOTE

A very excellent utility for dealing with aliases (among many other things) is File Buddy by Laurence Harris. It enables you to create aliases at standard size, half-size, or just the name of the application or folder. This is really useful for maximizing desktop space.

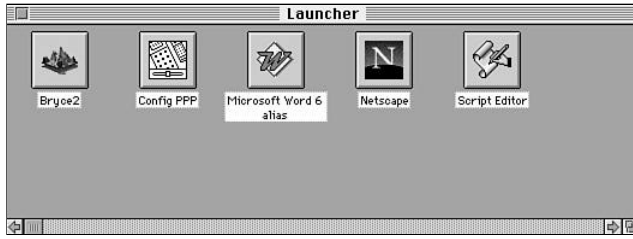
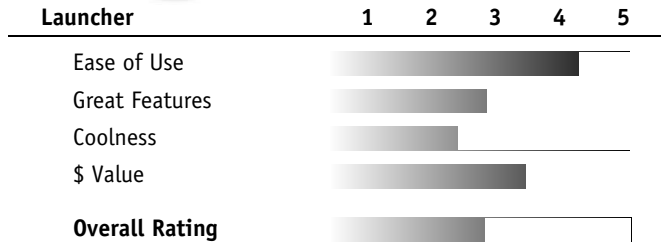

Figure 1.16
The Apple Launcher.

Ratings



Apple Menu Items

Using Apple Menu Items is the second best technique I know for navigating the desktop. (The best is coming in the next section.) In case you hadn't noticed, the stuff under the Apple menu is always available to you. This means that an alias placed in the Apple Menu Items folder (within your System Folder), gives you access to that alias from anywhere. Just drag an alias into the Apple Menu Items folder, and it automatically appears without rebooting or even closing any applications.

All your applications can be placed in that one spot, and opened instantly. This is one of the easiest ways to launch all your applications from the same place.

NOTE

The Apple menu is arranged alphabetically, which sometimes can cause difficulties, requiring you to scroll down to find an application. Add a space or other punctuation to the file's or program's alias to make an item appear at the top of the menu, getting around the alphabetical hierarchy.

Easy Access to Information

There are many forms of information that you juggle on your Mac. Whether it's creative jobs, a client's phone number, notes on hours worked, or dollars spent organizing and accessing that information the computer helps you work faster and smarter.

The Best Organizational Tip I Know

In some ways, I'm setting myself up in starting this way. Those of you who know the tip might think that I lack access to some of the more esoteric

Mac knowledge, and those who don't know it just might not find it helpful. I call it the best tip I know because I say a quiet prayer of thanks each time I use it, and can't imagine having ever lived without it. Sure, the TV remote is a basic idea, but I'll bet you wouldn't want me taking yours.

The logical extension to using aliases and the Apple menu is to create an alias of your entire hard drive, and place it in the Apple menu. The result is that you will never open your hard drive again. From any point in your system, you have point and click access to any file, application, control panel, or Sticky Note (see Figure 1.17). It's all there. Add an asterisk to the name so that it shows up first, and you're in business.

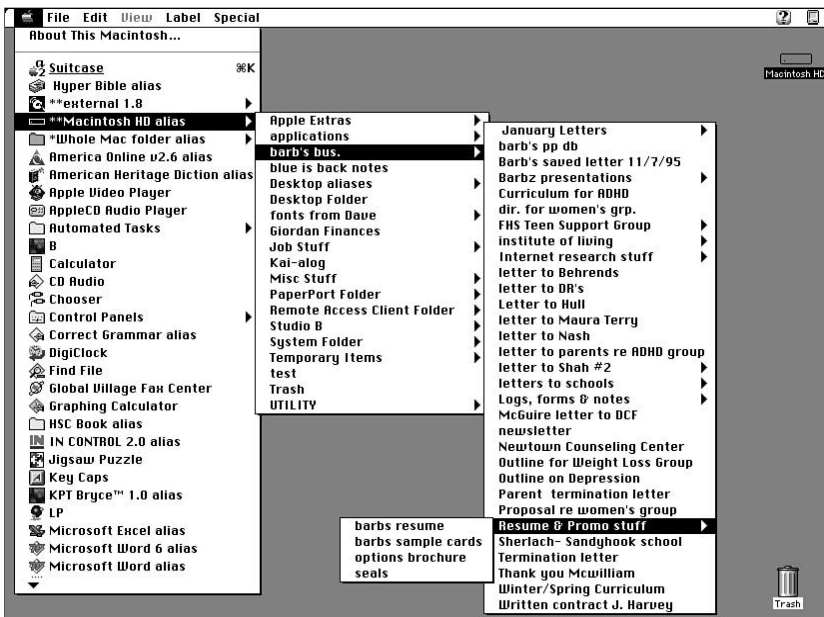

Figure 1.17
Accessing an entire drive through the Apple menu.

The “Recent” Apple Menu Items

Apple has placed other navigational tools in the Apple menu, with which you should become familiar. They're not the sorts of things that most people use every day, but from time to time they can be of help.

They enable you to access the most recent items you have used. Click the Apple menu and scroll down to the Recent Applications name. It shows you the list of your most recently opened applications. The same goes for recent files or servers. This enables you to go back to that file you were working on at 1:00am, even if you can't quite remember what it was called.

DigiClock

With companies like Apple and Adobe spending millions of dollars perfecting the mega-applications, the small, independent software writer is often left to polish the small details. They do this by publishing small applications, applets, and control panels that perform specific tasks very well. They usually exist as shareware, so for ten or twenty bucks, you can have some real handy items.

One such item is DigiClock (see Figure 1.18). It is a small clock that floats on your desktop. Although it does give you various display options and other cosmetic niceties, the thing I like about it is the stopwatch feature. For those of us who bill clients by the hour, it's nice to click a button on the desktop and forget about it until we're finished with a particular project.

DigiClock also gives full system data, such as version, installed RAM, and monitor depth, all from the small floating clock. It includes a menu that gives full access to the control panels for monitors, sound, and time set, so that you can change those parameters from the desktop. This

is less helpful given some of the other techniques I've described so far, but the fact that I have an on-screen stopwatch is reason enough for me to pay the ten bucks.



Figure 1.18

The DigiClock in the stopwatch mode.

Parking Places for Information

Say that someone emails you their mailing address. It seems silly to write down the address on a piece of atom-based paper, yet you don't want to put it in your electronic address book, since you might only use it once.

The most accessible and most transient place to copy data to is the Clipboard. Because that only holds one piece of information at a time, and cannot be referenced easily by itself, it tends to serve only as the transportation medium for information. Copy the address from the email to the Clipboard, and then paste it somewhere else.

Two good places to paste it are the Sticky Notes, and the Note Pad (see Figures 1.19 and 1.20). Some people like Sticky Notes because they look just like the real ones, and they can be moved around the desktop. I don't know why I don't like Stickies. Maybe it's just my desire to keep my screen as uncluttered as possible, or perhaps it's that Stickies are just an example of metaphor for the sake of metaphor. They just don't work for me.

NOTE

The Stickies and the Note Pad can access a rather interesting, and in my opinion, the most fun Easter Egg in the Mac OS. Simply type the words, "secret about box" in either desk accessory, highlight the phrase, and drag it to the desktop. I won't tell you what it is. Just give it a try.



Figure 1.19
Stickies

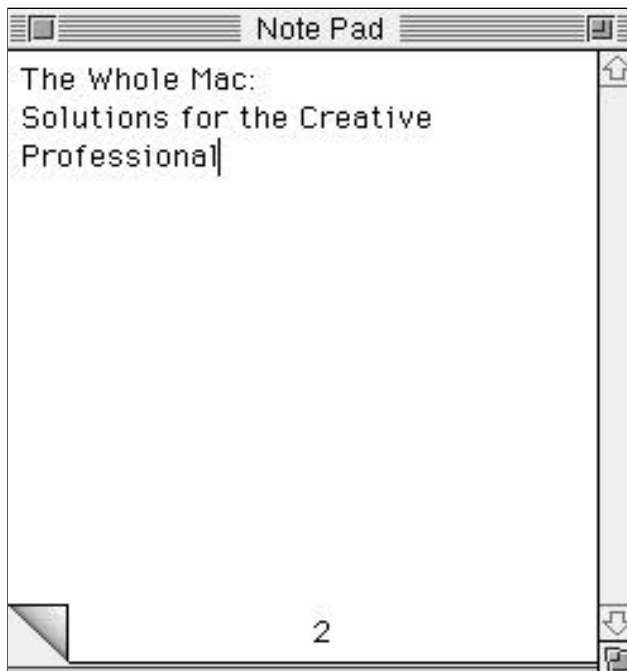

Figure 1.20
Note Pad

I find the Note Pad much more versatile. It stays in the Apple menu where it belongs, and the window can be as small or as large as you want it to be. The Note Pad offers plenty of space, and I never lose information that I put there, which is more than I can say for the pieces of paper around my desk.

Customizing the Handling of Images

In the same way that you sometimes need parking places and transient spots for text, if you work with images, you sometimes need a temporary place for them too. Maybe you just want to look quickly at a file, without waiting through Photoshop's entire startup routine. Or perhaps you use an image frequently (such as your logo), and you would like it at your fingertips. This section contains some practical ways for you to customize your system to handle these types of image requirements.

Using the Scrapbook

Apple has been telling people since 1984 to use the Scrapbook for frequently used images. People nod their heads and say it's a good idea, but not enough people use it. Because it's not my intention to preach, however, I'll just give this friendly reminder and move on.

For those of you who might be new to the Mac, the Scrapbook is a place for storing images that can be accessed through the Apple menu. In the same way that the Note Pad stores text notes, the Scrapbook can be used to store image notes. To use it, simply open it and paste any image into it. Images can be copied out of the Scrapbook and pasted into other documents.

Image Viewers

If you work with a lot of images, there are times when you want to look at a file without opening all of Photoshop or Live Picture to look at it. For cases such as this, you can use image-viewing shareware programs, such as Jade, or a utility called QuickShow, developed by MetaTools (see Figure 1.21).

Jade is a shareware JPEG image viewer and is definitely the more straightforward of the two. It enables you to open multiple JPEG images, compressing and decompressing multiple files at once. This can be a real time-saver if you work with multiple JPEGs. It is a small, solid application that uses very little memory to do its magic.

QuickShow is a flashy utility that shows PICT and JPEG files, as well as QuickTime Movies. The great thing about QuickShow is that there are virtually no controls or commands. Just drag the image files into the same folder as QuickShow, and launch the application. The screen goes black at that point, and the show begins. The images can play automatically, at defined intervals, or with a mouse click.

There is nothing that has had a more profound and more positive impact on this company than the implementation of our technology strategy. That strategy is based heavily on Apple Computer's ideal of easy-to-use, easy-to-network (yet powerful and meaningful) computing. We often do not even notice the computer-driven aspects of the amazing things we are able to do for ourselves and our clients because the user experience our network provides is so natural.

Thom Unterburger,
Chief Technology Officer
for Desgrippes Gobe &
Associates.

TIP

Try copying the color map from the Scrapbook, and pasting it into the Map control panel. This at least gives you a color image within this otherwise useless control. (Don't throw out the Map if you use Eudora for email, because Eudora references the time settings in the Map control panel.)

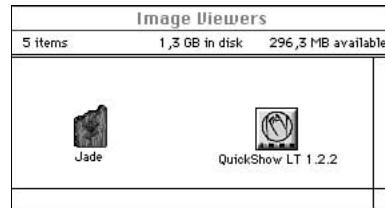

Figure 1.21
Jade and QuickShow

Screen Captures

For visual people, there is nothing like taking a picture of something for future reference. People who think and process information visually are usually drawn to the fact that there are many ways for them to take a snapshot of the contents of their Mac's screen. Some do it as a quick reference on the progress of a design, others do it to visually record their file systems for a backup. One of the most obvious uses for screen captures is for computer instructional purposes. This book is an example of such a use, but many of the larger agencies also make their own in-house training materials, using screenshots to show examples.

The capability to grab a screen capture is built into the Mac itself. Simply press ⌘-Shift-3 , and you'll hear a shutter click, signifying you have grabbed an image. The first image you capture is saved to your hard drive as a file called Picture 1, the second is Picture 2, and so on.

If you find you are doing a lot of screenshots, there are some good shareware applets that add a few extra features. Two of the best are Flash It and Capture, both of which can be downloaded from CompuServe, AOL, or other such boards. These programs enable you to assign your own keystroke combinations and hide or show the cursor in the shot. They also enable you to draw a marquee over just the portion of the screen you are interested in, cropping it as the image is captured.

Although they are similar in many respects, Capture outperforms Flash-It on a couple of levels. Unlike Flash-It, which only captures images as PICT files, Capture offers four different formats, including PICT, TIFF, GIF, and MacPaint files. You also can save directly to the Scrapbook or to the Clipboard for pasting into other files. Capture makes it easy to select the destination of the image files, and even enables you to name them at the point the shot is taken via a pop-up screen. This is so much more convenient than having to go back later to name the image, hoping you remember which was which.

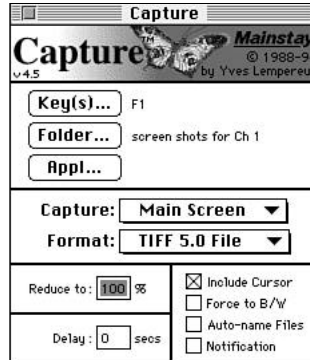

Figure 1.22
The control panel for Capture

Automated Tasks and AppleScript

AppleScript is a powerful scripting language from Apple that automates certain computer tasks. It is not for everyone, because it does require learning a list of terms and codes, as well as thinking through the steps necessary to automate something. There is a fine line between customizing the computer for your work, and having all of your work go into customizing the computer. We draw near to that line as we discuss AppleScript, yet it does offer the most customization of all.

System 7.5 offers something called Automated Tasks, which are pre-written AppleScripts that can be run as-is. They enable you to start file sharing and share a folder, or make an alias and add it to the Apple menu, just by selecting them. They are located in the Apple menu under the Automated Tasks listing (see Figure 1.23).

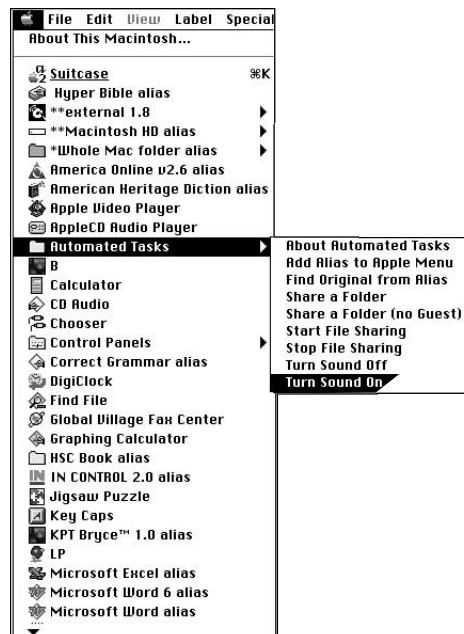

Figure 1.23
The Automated Tasks menu

When an automated task is selected from the menu, AppleScript starts and runs the script for that task. You see nothing happening on-screen in terms of windows or files being opened. AppleScript does its work in the background, and when it is through, it displays a message screen reporting that the task had been completed.

The great thing about AppleScript is that it offers a natural, English-based set of commands that are easier to embrace than most programming languages. If you find that you use Automated Tasks frequently, you may want to learn AppleScript so that you can create your own scripts. If so, there are many excellent books available to teach you the basics and beyond.

For more information on AppleScript, check out *The Tao of AppleScript* published by Hayden Books.

2

Organizing Your Files And Stuff

This chapter will help you to process the mounds of data that accumulate in your system. It also will help you become better organized and teach you how to back up and secure your system against catastrophe. For many designers (including myself), organization is a learned skill at best. In the pages that follow, you will look at what you need to learn for optimal organization, including why you should organize your data, and how to do it most efficiently.

I first thought of this chapter as the life insurance sales pitch of the book. With all the other exciting areas to cover, I thought this chapter would be akin to the insurance policy you know you have to buy, even though you'd rather be spending your money on a new car (or perhaps a new printer). Then I had a change of heart. I realized that people buy life insurance because death is inevitable, whereas the tips contained in this chapter will actually help you avoid terminal data problems. That tragic crash in your system CAN be avoided. I then started to think of myself as some digital Jack LaLane, teaching you how to whip your flabby file and back-up systems into shape. Come on now, click that mouse, print that file...

If you want to know... Go to...

What is a disk image and how is it useful?	34
How can I avoid conflicts when I install new software?	35
How can I avoid control panel and INIT conflicts?	35
What is the best media for archives?	40
What sort of tape drive do I need for backups?	41
What can I do about corrupted files and viruses?	36

Data Management in the Creative Environment

File organization is important for the following three reasons:

- To avoid missing deadlines
- To avoid wasting time
- To avoid a fatal crash

Avoid Missing Deadlines

When you're on a tight deadline, two of the most important things are time management and focus. Losing files and fonts can be distracting even when there's plenty of time to find them. Lose a design component on deadline, though, and there's no time to do it over. You either stop what you're doing to find it, or you get along without it. This means you pull your focus from being creative to hunt for a file, or you settle for something less than your best. In this scenario, disorganization can directly impact the quality of the work you do.

The other side of the coin is that you are done designing and are racing to get a job to the service bureau. The problem is, you can't find all the fonts, high-res images, or copy that go with the layout. The courier is waiting, tapping his foot, until you send him away empty-handed. Hopefully, everything is found, and the job gets out, but it could have been done sooner and easier.

Our growth was largely facilitated by committing to the Macintosh platform. No other platform would have resulted in such marked productivity increases, modularity (true plug and play, but on an enterprise scale), at such a reasonable price.

Thom Unterburger,
Chief Technology Officer for
Desgrippes Gobe &
Associates
New York, NY

Avoid Wasting Time

Disorganized people usually are forced to repeat themselves—redoing jobs, reloading software that corrupted, or looking up a client's phone number for the fifth time. Sometimes they repeat themselves by opening the same folder every time they look for a particular job, only to realize that it's not there, and they have to hunt for it elsewhere.

When you have multiple versions of a client file, it's confusing to you; when you have multiple system files (or folders), it's confusing to your system. A disorganized system is prone to intermittent failures and problems. This means that your system locks up frequently, you can't print, or perhaps you can't mount your drive.

Any of these glitches can disrupt your day, and throw your projects off course. The end result often is frustration on the part of the user. He or she blames the technology or the manufacturer, or perhaps just thinks technology is out to get them.

Avoid a Fatal Crash

What would you do if you turned on your machine today and nothing happened. Or perhaps you just get a diskette with a question mark, where the Happy Mac used to be. What would you do? When is the last time you backed up? Last week, three days ago? How much work have you done in the last three days?

Being organized isn't necessarily going to prevent the fatal disk crash, but it can soften the blow when it happens. I know I said earlier that being organized can help to avoid system failures, and to a degree, that is true. All computers and hard drives, however, are mechanical, and all mechanical things do break down eventually. It's not so bad to replace your hard drive though, when you know you have your data safe and sound, waiting to be restored.

Organization

An effective organizational system does the following three things:

- It backs up and protects all of your data.
- It gives you the confidence to back certain things off for archiving, which opens up extra space on your hard drive.
- It puts the most frequently used items at your fingertips while moving the things you seldom use into the background. (It gives you what you need, when you need it.)

How your system does all this is up to you. This chapter will outline most of your options, detailing the pros and cons of each. Beyond that, it's up to you. Each studio or environment is unique, and each of us has a different temperament and approach to organization. No matter how you choose to do it, though, your system should facilitate the three points listed above.

Loading Files

The way a file or an application is loaded onto your drive determines how it functions with your system. This is less true for files, but it is extremely critical for applications and system files. In the old System 6 days, a utility called the Font/DA mover installed these components exactly where you needed them. Today, the temptation is to drag and drop files wherever you need them. This doesn't work well for applications, which need to be installed in a specific way.

Follow the guidelines here for reliable and safe application installations.

Making a Disk Image

Most software or utilities will be loaded using an installer. This makes it easy to double-click the arrows and insert the other disks when you're asked. Realize, however, that the software company used an installer for a reason. It is probably because some files needed to be installed in the System Folder or in Preferences. You can't always tell exactly what the installer does, but just know it's there for a reason.

Let's say that your son places his toy magnet on the Photoshop installer disk you just bought for 600 bucks. Everything is erased...gone...poof! Sure, you probably can call Adobe and have something sent to you, but that will take a few days, and you have work to do now. This underscores the need to make a copy of all the application diskettes you get. In this way, you can lock up the original application disks for safekeeping, and load and reload with the duplicates you've made.

When duplicating a diskette, you should never copy items from one place to another via dragging. This is a sloppy and imprecise way of copying disks, and more often than not, it doesn't work. You must make a *disk image*, which is an exact copy of the original disk down to the icon placement and size of the window. More importantly, any invisible files and paths for file placement also are preserved exactly as the original. To make your disk image, you should download a piece of shareware called Shrinkwrap. It's fast, easy, and has some great features.

Reading the Read Me Files

After you've made the copy and are ready to install, resist the impulse to plunge blindly ahead, and stop to double-click the Read Me file. This file contains any last minute information about installation, compatibility, and various functions that may not appear in the manual. You may discover a known bug or a conflict with another program that you're using. This is important information that can save time in troubleshooting and head-scratching.

Getting Ready to Install

Before installing, go to the Memory control panel, and turn down the Disk Cache as far as it will go. Then disable any virus protection programs. Having done all this, restart the machine holding down the Shift key, until you see the greeting that says "Welcome To Macintosh, Extensions Off."

Installing

Double-click the installer and load the disks as you are asked for them. When the installer is finished, restart your Macintosh. Most applications force you to restart before you launch, but in case yours doesn't, restart anyway. You can run into trouble if you try to launch a freshly loaded application without restarting first. While you are restarting, hold down the \mathcal{H} -Option keys and rebuild the desktop. Remember to allocate enough memory to the application before you launch it, using the Get Info dialog box.

NOTE

To allocate memory to an application, simply select the application's icon. Then, under the File menu, choose Get Info ($\mathcal{H}+I$). In the Memory Requirements section of the dialog box, type the amount of memory you want to allocate. Allocate at least the minimum size, but be careful of allocating too much—you might see diminishing returns.

Avoiding Conflicts

There will be times when you do everything according to the book, and things still don't work. This is because you have so many different products in your Mac made by dozens of different companies. All of those companies and their products are vying for your Mac's resources. When two applications, control panels, or extensions argue over the same turf, you can have conflicts. These usually show themselves in the form of freezes, lockups, and errors. Applications are seldom the culprits, though. It's most often the control panels and the extensions.

NOTE

If you lock up as the Mac is booting up, it's almost always an extension or control panel conflict.

INIT and Control Panel Conflicts

If you have a problem during startup, the first thing to do is to see if it's repeatable. Reboot your system and see if it repeats the problem. If it does, determine at what point the problem occurs. Does it happen during the Welcome to Macintosh screen, or does it happen when the little icons load across the bottom of your screen? If it's during the Welcome to Macintosh screen, chances are that something is corrupted within your system, and you should take the following steps to reinstall it:

- Reboot using your Disk Tools diskette or Mac OS CD.
- If using the CD, reset your startup disk to the CD using the Startup Disk control panel, and then reboot. (Your Mac will run slower from the diskette or CD-based system; this is normal.)
- Go to the System Folder and throw away the System File and the Finder.
- Go to the Preferences folder and throw away the Finder Prefs file.
- Empty the Trash, and reload software from the disks.

If the problem appears while the icons are loading across the bottom of the screen, then you have an extension or control panel conflict. These conflicts can be resolved by either changing the loading order of the items or by removing one of them. If your machine locks up at the same point in the icon loading process, chances are that it's the icon currently being loaded that is the problem. It may be having a local conflict with the extension on either side of it. Changing the order it loads may make the problem go away. To do this, reboot holding down the Shift key, which starts your machine with your extensions off.

If rebooting with extensions off does not resolve the locking up problem, try reinstalling the system as described previously. After extensions are off, open the system's Extensions folder and click the name of the conflicting item to highlight it. Then click at the front of the name and add a space or an asterisk. Because extensions load alphabetically, this will change the loading order, and could make the problem go away.

If it doesn't resolve the problem, try removing the extension completely from the System Folder (not to the desktop). Now reboot and see if it resolves itself. If the problem goes away, try calling the software company that makes the item, and make sure you have the current version. If not, ask them to send it to you. If you do have the current version, ask them if there are any known bugs when running your configuration, and if they have a fix.

Corrupted Files and Viruses

The corrupted file has gotten something of a bad name in the computer industry. Whenever something goes wrong with a file copy or some other system issue, the first thing somebody says is "You must have a corrupted file." A file becomes corrupted when a piece of its data is unintentionally changed or modified by the system. This is extremely rare, and you should rule out all other suspicions before you decide a file is corrupted. If a file is corrupted, you have no recourse but to restore it from a backup.

The few instances when corrupted files become more likely are with fonts and cold boots. Fonts occasionally get corrupted, and they are easy to spot when they do. A corrupted font can cause printing problems that go away when the font is changed. In addition, the font name can appear garbled in the floating palette or the menu. At times, fonts will give you the wrong typeface for no reason. (This, however, also happens when you open fonts with Suitcase while an application is running, so be careful not to assume here.) In general, if a font begins to act strangely, you should suspect that it is corrupted, and reload it from the disk copy you made. (The original font disk is stored away for safekeeping, right?)

When you think you have thrown away an important file, don't panic. Don't throw anything else away and don't copy anything to that hard disk. Launch your recovery application, make an offering to the memory goddess, and when you have a directory of files recover them to a different disk. Don't confuse the matter by writing over the data you want to recover. Sometimes it takes more than one attempt.

Stella Gassaway, AIGA
bYte a tree productions
Philadelphia, PA

Systems do not like cold boots. A *cold boot* is when you power off the machine without warning, and turn it back on. Occasionally, a cold boot can make bad things happen to your system. When your machine freezes, you should try to force quit the application you are in first (Option-⌘-Esc). If this doesn't work, try a warm boot by pressing Control-⌘-Start. If these two options don't work, you must reboot by powering the system down and back up, using the button located either on the front or back of your Macintosh. Although it is not good for your system, it is nothing to panic about either. Usually your system comes up, flashes you that annoying "This Mac Was Not Shut Down Correctly" message, and goes back to work. If for some reason you notice problems right after a cold boot, then you might suspect corrupted files.

If all of the other tips for diagnosing and fixing system problems don't work, then you may have a virus. The only real treatment for viruses at the user level is prevention. Once loaded into your system, viruses are hard to catch until they begin to destroy your stuff. It is at that point that you thank me for telling you to back up everything.

A computer virus is something of a Trojan horse. It copies onto your drive as an ordinary looking file, and then does its dirty work from within. Some viruses begin corrupting data right away, whereas others are set on a timer, activating themselves on a certain date. Some viruses are just in fun, flashing a silly splash screen, or doing some other harmless mischief to get your attention. Others will do things such as disable all the vowels on your keyboard...not very funny at all. Harmless or ruthless, a virus must be copied to your hard drive for it to access your system. That's what's so infuriating about viruses, you actually invite them in to do their damage.

Many virus protection programs are available. Two of the most popular are Virex from Datawatch and Sam by Symantec. Using elaborate Preferences options, you set these programs to keep watch over your system, scanning every single disk and platter that seeks to copy files to your main drive. This is especially important with the Internet, where people are downloading files from Sri Lanka by way of a server in Pittsburgh. Downloads, SyQuests, and any other media should be scanned. If your friend loans you his hard drive, you should scan that, too.

When you purchase a virus protection program, don't just sit back and think you've done your job and you're safe. Those destructive and insidious programmers are out there writing new viruses even as you read this. The good virus protection programs constantly are upgraded to screen out the latest viruses, and you need to continually upgrade to keep pace.

Outdated Applications

Today's software is optimized for the latest hardware advances. Trying to run an application that was made in the late eighties or early nineties could cause problems with the machine, as well as with other programs. A general rule of thumb is that if a product predates System 7, you should upgrade it or dump it.

Troubleshooting Programs

If you want more help in diagnosing problems in your system, there are two applications you should own. Norton's DiskDoctor and a program called Help! from Teknosys work side-by-side to make sure your system doesn't run into problems.

Norton's DiskDoctor is quite famous as the old guard of diagnostic programs. Norton examines your data from a directory and file level, making sure that each pointer and filename is where it should be. It repairs problems, defragments your hard disk, and provides a report.

Help! operates on a different level. It examines all the files on your Mac, and uncovers compatibility problems based on the combination of files you're using. Help! is fantastic for spotting conflicts between Inits and extensions, as well as picking up known incompatibilities between various application versions. Help! relies on a vast database of known Mac problems. It also delivers a detailed report, telling you exactly what to upgrade, as well as giving you the company name and number to call.

Finding and Making Space

Computer users have had just two requests since personal computers began dotting the landscape in the early eighties. One is for more speed, the other is for more space. All other requests are simply derivations of those two. Space becomes even more critical as technology advances. It is only as we are able to support 24-bit color, using disk arrays and 256MB of RAM that large files are even possible. Add the requirements of technologies, such as digital video, and space requirements increase further. Therefore, a key component in managing your files is in managing the need for space.

For computers to operate efficiently, they must have a certain amount of free space on the hard drive. If you find that you constantly are encroaching upon the last 10 percent of your drive's space limits, it's time to back up, and get a new drive.

Storage Methods

For a designer, it is imperative to develop a strategy for on-line, near-line, and off-line storage. Each of these storage methods must be thought out and addressed to completely address file management issues.

On-Line Storage

On-line refers to data that is accessible to your system at all times, typically from your startup hard drive. Many Macs support a second hard drive, internally or externally, which also is considered on-line.

On-line information is information you require access to on a daily, if not hourly basis. The more often you need it, the more it needs to stay on-line and at your fingertips.

Files that fall under the on-line definition include applications, system files, and current jobs. A key to managing your data is in recognizing when

data no longer needs to be on-line, and can be moved over to near-line or archival. Current jobs are a perfect example of this. Many studios move a job to near-line as soon as the deadline is met, and others wait a few weeks or a month before moving the data off their system.

Near-Line Storage

Near-line is data that can be accessed via some sort of mountable, removable media. Near-line storage used to mean just one thing: SyQuest. Today it means a lot of options that all promise to deliver fast, high-capacity, low-cost storage solutions. Near-line is perfect for files that you only need to look at occasionally, for reference, or to access sporadic information. Backing a client's work off to a cartridge makes great sense considering you can still access it if the client asks you a question about it next month, or if you want to grab the photo from the job you did last October.

When looking at near-line storage, it is important to consider the role the removable drive will play in your shop. Will it exist solely to serve your organization, or do you need to send disks to your service bureau? If so, you need to make sure your service bureau has a drive that can read your disks. What about other clients, freelancers, or other collaborators? You should stay as compatible with as many people as possible, or perhaps get two drives. With two drives, you can use a SyQuest (which has the largest installed base) to share disks with everyone, and use a Jaz or Optical for your primary near-line device.

At our studio, we back up all our files every night. The multimedia stations have Python DAT drives that run on scripts automatically every night. If you work late, don't bypass the script. Have a cup of coffee or get something to eat and let your machine do its thing.

Stella Gassaway, AIGA
bYte a tree productions
Philadelphia, PA

Off-Line Storage

Off-line is an archival solution. Archival usually refers to tape backup, and is used for data that is stored away as a permanent record.

A Cartridge is not Archival

A fatal mistake that many design groups make is to confuse removable media products with archival products. This is due to the fact that most design shops have cartridge drives in-house, and disk space usually is scarce. Therefore, when they need to move data off their drives, it goes to a cartridge. This is fine if it then gets backed up elsewhere, but more often than not, it simply stays on the cartridge.

continues

continued

The whole idea behind true archival products is that the data is securely preserved, hopefully forever. Tape cartridges and CDR solutions conform to this spec due to their media stability. Removable cartridges are not as reliable. They can be damaged if dropped, left in the sun, or just overused. The result is that an agency installs a cartridge to reference a job done last year, only to find the disk damaged. Since ejecting or reinitializing the disk are the only options at this point, the data is often lost. Removable cartridges are terrific for transporting files between systems and for sharing data, but they do not have the shelf life to reliably archive your files.

On-line and near-line options and procedures are pretty simple. You just look at your storage habits, and copy the files where they need to go. Off-line storage is a little different. Off-line strategies do not cover just one machine, they cover all the systems in your organization. It requires looking at how much data you need to store, how often you will store it, and how you will create a system that minimizes loss should a failure occur.

Backup Hardware Options

There are two types of tape drives used for archival back-up:

- Drives for network or server backup
- Drives for individual backup

While an argument could be made that a 2.6 gigabyte Optical or a 1 gigabyte Jaz could function as archival, they do not have the capacity and speed to efficiently support multiple machines or extremely large volumes.

Both network and individual tape drives can use various compression methods to fit more data on a tape. In the Mac arena, it is hard to make an argument for using any back-up software other than Retrospect from Dantz development. Dantz has been backing up for the Mac since the eighties, and it has an easy to understand yet comprehensive product. Retrospect works for a single user, as well as for workgroups and even allows remote backups of multiple systems. The great thing about using Retrospect is that it enables you to use it on a smaller back-up device, and take it with you as you move on to more advanced hardware.

I spend all day working on my computer and have several hard drives and removable media for backup. I have long preached the importance of backing up files because of the quirki-ness of files and disks.

I thought it would never happen to me, but it did. While my reliance on this technology has opened up the doors to creative possibilities and given me ownership over media that I never would have been involved in before, it has also made it easier to be crippled in the event of tragedy under deadline.

Erin K. Malone
EM Design
Sunnyvale, CA

Capacity

In evaluating tape drives and compression-based tape drives, the rated capacity must be considered as the theoretical maximum. The capacities achieved in day-to-day use often are significantly less. The actual amount of data that will fit on a given medium will vary due to many factors. For instance, a tape's capacity can be greatly influenced by the relative speeds of the backup computer and the tape drive. Another factor is compression, a feature of some drives and software that reduces the size of the data being backed up. *Theoretical maximum capacity representations* refer to the amount of data before it is compressed by a tape drive with hardware compression capability—and it often assumes generous compression rates.

NOTE

You should buy the highest capacity tape drive you can afford. You may not want to buy that 136 gigabyte autoloader if you only have a 1 gigabyte drive, but an 8 gigabyte unit for a 1 gigabyte drive is not unreasonable.

Compression, Security, and Encryption

Compression is the backup's way of finding global patterns in the data that can be compressed, reducing the size of the data to be stored. Compression can be handled by the hardware or the software. If you have the choice, hardware compression is always faster. In cases where you will do both compression and encryption, however, you should always allow the software to handle both aspects of the procedure.

All backups can be password protected to prevent unauthorized access to data. It is a good idea to put some sort of password on your backups if you feel there is a slight chance of prying eyes. A note of caution, however, most high quality back-up software, including Retrospect, do not provide a back door to get around a forgotten password. While this is good security, it also requires you to have some system for not forgetting a password after you use it.

Encryption takes security a step further. While a password system forces the user to figure out the password, an encryption scheme generally forces the user to be using your system. Encryption codes the data, which scrambles it, leaving it useless unless the encryption code is present. This means that even if someone has your password, the data will be illegible unless it is decrypted.

Network or Server Backup Hardware

Backing up servers and entire networks of computers requires hardware that can store extremely large quantities of data (hundreds of megabytes, even gigabytes) over a relatively short period of time (over night or weekends). Fortunately, there are many reliable, high-capacity backup devices available from which to choose.

When looking at network backup, you should look at the following parameters to help you determine your needs.

How much back-up room do you need?

- Determine the total amount of data you need to back up across all the machines.
- Calculate any redundant data, such as system information, applications, or other things repeated on more than one machine.
- Determine your compression rate. Application files usually do not compress very well, while data files compress much better. Figure 50 percent for data and 30 percent for applications.

How long will it take you to back up?

- Consider the total compressed amount you need to back up.
- Consider the speed of the Mac sending the data across the network.
- Factor in the network physical layer. Consider that Ethernet can usually support up to 240MB per hour, while AppleTalk supports up to 60MB per hour.
- Decrease the relative network speed by 5 percent for each router encountered, as routers slow network back-up performance.

As network capacities stretch upward into the dozens of gigabytes, be sure that your drive's capacity is large enough to support unattended backups, without forcing you to be there to change tapes. Autoloader systems do just that, supporting from 6 to 17 tapes, each containing up to 8 gigabytes of compressed data. This means that the 17 tape unit will store up to 136 gigabytes of data, completely unattended.

What Mac Should You Use?

Which Mac to use as your central back-up device is a point to consider as well. You should use a more powerful machine if you are supporting a great deal of machines over a network. In addition, network backups place more RAM requirements on the system. It's hard to be specific here, but the larger your network volume, the more RAM you should use. Finally, remember that compression and encryption place added processing strain on the Mac as a back-up device. If you do one or both of these procedures, you should go for the faster machine.

You also need to determine whether your server should back up, or your desktop machine should do the honors. There are pros and cons to each approach, and your own unique circumstances will ultimately decide for you. Consider the following points though.

A desktop machine:

- Is generally close at hand, rather than locked in a closet.
- Is generally not slowed down if you back up at night, (and don't run a third shift).
- Does not slow down access to the server at night (if you do run a third shift).

- Is cheaper than a full-blown server. For just a few machines, something as basic as a Mac LC can do the job.

A server:

- Is usually faster than a desktop unit, although this may not be true in a production environment.
- Can be set to run during low server activity periods of nights and weekends.
- Is more secure if the server is locked up or less accessible.

Back-up software may have compatibility issues with other server applications such as email hubs and early versions of AppleShare. Investigate any possible conflicts like this before deciding on a server.

Data Management Strategies—Setting Priorities

It is possible to implement all the ideas discussed thus far and still not have a system for managing all your data. To pull many of these ideas together into a cohesive way of working, the Mac OS builds in an effective set of organizational tools. Combining the ideas discussed thus far, along with the Mac OS options and your own priorities as a business, will help you define your file management system.

Many of the items in this section were discussed in Chapter 1, “Making The Desktop Your Own.” That chapter looked at the Mac OS from a customization standpoint, getting you familiar with how the Mac works. This chapter looks at the specific options that facilitate the organization and management of your system. It will consider options for organizing your files and plugging in specific tools as they are needed.

Options for Finding and Organizing

Where you put things affects how easily you can access them. Ease of access is tied directly to how frequently you need an item. Just as the on-line/near-line/off-line scenario prioritized placement based on how often a file is needed, the decisions here should be based on frequency of use.

The Apple Menu

The most accessible place to put something in your system is the Apple menu, given that it is always available, regardless of application or activity. I still feel that putting an alias of your entire drive volume in the Apple Menu Items folder is the best way to access everything, all the time. This is the only method I know that facilitates easy access to files, applications,

and system items. If that doesn't grab you, you can still use the Apple menu for placing key application aliases, or perhaps current projects. You also should think about weeding out certain items you never use, such as the Jigsaw Puzzle or Recent Servers. The reason is to make the menu as short as possible, making it easier to navigate. Don't forget to add punctuation or spaces to an item's name to control what order it appears in the menu.

The Desktop

The second most accessible spot would probably be the desktop or the Launcher (via an alias). The desktop is an easy place to put things, and it is certainly easy to make an alias and line it up at the bottom of your screen. When you need to open something, you click the desktop to activate the finder, and open the alias. This works well for applications, but is impractical for files and more unique items.

Folders

Folders are problematic in that they have a tendency to nest within each other, making you click through several levels to get what you need. Either that, or they squeeze too many items into one level, or they simply limit the number of items. This is how most people handle files. There are so many of them, that there seems to be nothing else to do but to nest them in folders.

Icon Size Variation

The size of your icons can be controlled through the Views control panel. Experiment with various sizes to see what works best for you. Keep in mind that whatever you choose at the control panel level impacts every window you open. This is different from using the View menu in the Finder (see the following).

Window Formats

The View menu looks at each window as a separate entity, and enables you to set up your window accordingly. You can view by size to evaluate which files or folders use the most space, or you can set it to view by date to see the file you created most recently, sitting at the top of the window. Other options such as Label and By Icon enable you to set parameters, such as color coding or custom icons, and view the results in appropriate windows.

Color Coding through Labels

As you look at file organization, consider how much variation a particular method allows. Labels are a good example of an option that works really well, but that may be too limited in the amount of variation it offers. It

enables you to select an icon and apply a color to it. You also can create any color you want via the Labels control panel. You only have seven colors, though, so everything in your labeling system has to fit within seven classifications.

Think of Labels as being useful for general classifications, such as the job types discussed in the next section. If you only have seven clients, list them each with a color, or perhaps you give a color to each day of the week, or to each of Snow White's dwarfs.

Creating Custom Icons

I really like using custom icons. It helps me to see what is in a folder with just a glance. Chapter 1 discusses how to make custom icons, this section looks at what to make.

Obvious choices for custom icons are client logo folders, perhaps even customized for each project. Custom font suitcases also are an option, as are application folders with application icons. Think about icons that can designate various functions in your office. Can you put each person's picture on their personnel folder? What folder icon would you designate for billing and accounting files? Designers are a visual bunch, and coming up with a system for the various file types you work with can make life easier.

Try to make each icon as distinct as possible to avoid confusion between files. In addition, consider how an icon will look when it is highlighted. How can you design it color-wise to make it work well while highlighted and unhighlighted? (The Color control panel enables you to set the highlight color.) Another factor is labeling. Because you can create your own label colors, you can create a custom icon with seven variations. Just make sure that the icon design works with the colors you've created for labels.

Putting It All Together

What follows is the system I use in organizing my files. It is not workable for everyone, but I list it to illustrate how the principles covered in this chapter can be put into practice. I begin with a basic idea that everything on my desktop is either a tool or a product. That distinction determines my priorities as I figure out what to do next.

Workflow

Efficient and secure workflow is the reason for this entire chapter. A good workflow system means that the computer becomes your ally, and it feels like there is less of a barrier between you and your work. When you need something, it should be close at hand, and when you're done with it, it should blend into the background.

Effective workflow means that you never waste time looking for things in your system. It also means that your system is well organized and is not prone to freezes, lock ups, or other technical issues. So, you don't waste time fixing things. And because you never lose things, and you never have system crashes, you never waste time doing things over.

The Product

When I consider how to organize my information, I try to make everything revolve around my product, whether it's the designs I do or the words I write. These are my products. They are the things that make me money, and determine if my business is successful. If it is not a product, I want it to fade into the background.

On the other hand, I use certain tools to make my products. This means that when I need Photoshop to do image editing, I want it opened pronto. I want my Mac to slap it into my hand, like a nurse handing a doctor a scalpel. The tools must be accessible, and not detract from the product. The following points outline my process for handling software tools.

- All software should be kept in a separate folder, hidden out of sight at the bottom of the main HD window.
- All software should be kept up-to-date with all major revisions.
- Access most software through a hard drive alias in the Apple menu.
- Make application aliases and add them to frequently used client folders, along with the jobs themselves.
- If it isn't worth buying, it isn't worth using. Never use pirated software.
- Monitor how often you use applications and utilities, if it isn't used, archive it or dump it.
- Keep an eye out for redundant tools. Understand the relative strengths and weaknesses of each program, and try to streamline your toolbelt.
- Never confuse your tools with your skills.

Develop a system for cross-referencing data between jobs. The same logos, blocks of copy, or photographs can be reused across a range of client projects. I want an easy way of sharing these resources with related client projects. To do that, follow these suggestions:

- Create central client folders, one containing recent jobs, one with variations of a client's logo, and one with client profile info.
- Put the client's logo on their main folder icon.
- Create a mini-image of the job, or some component of it, and put that on the job folder icon.
- Back-up older client work to CD with a CDR drive.

Develop a system to access art resources. These steps enable me to keep clip art and fonts close at hand, without having them eat up all my drive space.

- Keep generic images and line art at near-line. (A really good collection takes up too much disk space.)
- Try to keep a printout of clip art images close by for visual reference.
- Keep a CD library of images and eclectic fonts using CDR.
- Utilize Internet sources for stock images and fonts whenever possible.

Develop a system to cross reference job types—brochures, display ads, and so on. This enables me to cross-reference jobs by type, rather than by client or name. I may want to look at other trifold brochures or get some ideas for vertical business cards based on jobs I've done in the past. To reference these points, follow these suggestions:

- Use label names and colors to indicate job types.
- Write specifics about the job in the comments section of the Get Info window. Set the Views control panel to see comments in the windows.
- Access labels or comment information using the Find File feature, set to the appropriate variable.

Summation

There are many ways to process the mounds of data that accumulate in your system. Organization and backups secure your system against catastrophe. For many designers (including myself), organization is a learned skill at best. Look at how you work to decide on the best way to organize—and remember, always keep backups.

3

Managing Memory

Memory is everything.

It is more important than your applications or your hard drive.

It is without a doubt the most expensive component in a high end system, potentially costing upwards of ten to twenty thousand dollars for a fully loaded configuration.

If you're faced with a choice between buying a faster processor without much memory, or buying a slightly slower processor with more memory... take the memory.

Everyone knows that these things are true, but there are a great many designers who still don't understand *why* they are true. They just know that they need lots of RAM, which at least is a good place to start. This chapter looks at this greatest of all system investments in some detail, discussing how memory works, what applications use the most of it, how to shop for it, and how to install it.

If you want to know...

Go to...

Is there a difference between memory chips?	66
How do I allocate memory to an application?	53
What are the stack and heap?	52
What are the differences between Type I, II, and III PC cards?	61
What is VRAM?	58
Will a cache card dramatically increase my performance?	60
What do all of the acronyms mean?	50

Acronyms Abound

When we venture into the realm of memory, the acronyms really start to fly. The terms RAM, DRAM, SRAM, VRAM, SIMM, DIMM, EDO, PCMCIA, and Cache RAM are thrown about by techies and non-techies alike. Some know what these things mean, at least to the point of being able to recite the various acronyms back to you. My experience has been, however, that most of the people who know what these acronyms mean (usually the dealers), don't have a real understanding of how important RAM is for large files. They hide under catch phrases like, "More is better," and "You can never have enough RAM." When you're shelling out ten grand for a few chips you can fit in your pocket, I think you're entitled to more than catch phrases.

We'll dispense with the acronyms first, and then get down to explaining what all this stuff does. The list that follows contains definitions for the most important memory acronyms and terms.

RAM—Random Access Memory

DRAM—Dynamic Random Access Memory

SRAM—Static Random Access Memory

VRAM—Video Random Access Memory

SIMM—Single Inline Memory Module

DIMM—Dual Inline Memory Module

EDO—Extended Data Output

PCMCIA—(Also called PC card)—Personal Computer Memory Card Industry Association

Nanosecond—One billionth of a second. The unit of measure for the performance of memory chips

Chip—The engineering term for an integrated circuit

Module—The printed circuit boards on which chips are mounted

Virtual Memory—Apple's method of segmenting hard drive space for use as RAM

RAM Disk—The RAM disk is a block of DRAM that is configured to work as a hard drive

Modern Memory Manager—Apple's new Memory Manager, which is optimized for the native PowerPC environment

How RAM Works

RAM is a temporary storage place, which enables data to be fed to the processor at high speeds. When you buy memory, you actually buy modules, which are printed circuit boards that have RAM chips mounted on them (see Figure 3.1). The RAM chips are linked across the boards, and the system sees the cumulative block of chips as one cohesive parking place for information. DRAM is the most common type of RAM, and its acronym definition gives good understanding of how RAM works.

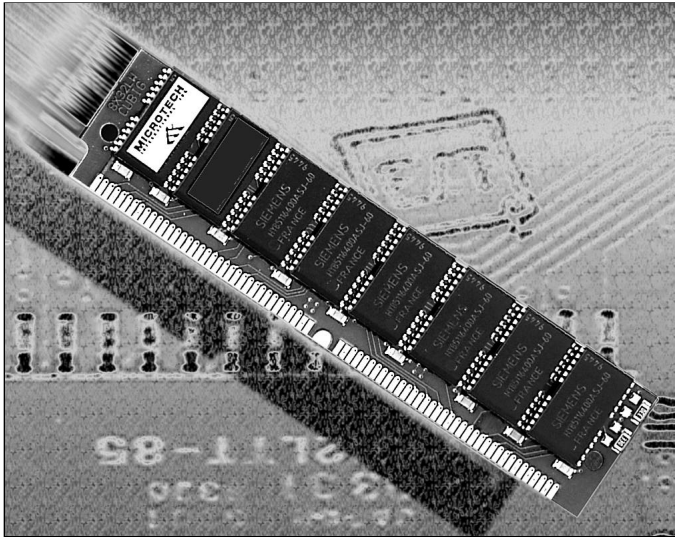

Figure 3.1
A RAM memory module

It is called Dynamic Random Access Memory. It is dynamic in that it is constantly changing, accessing information as it needs it, and then closing it and going on to something else. It is random in that the various memory components do not need to be loaded in a linear fashion. Instead, pieces of information can be stacked one upon another like blocks, which can be pulled out and discarded without discarding the entire stack. Another way to picture it is like a deck of cards, where cards can be added to the top or the bottom or inserted in the middle. Cards also can be withdrawn from any of these areas as well, either to be removed from the deck, or just shuffled to another part.

RAM Basics

The information in DRAM is not only dynamic and randomly accessed, it is also fast. Power Macintosh processors handle information so fast that they require a steady flow of information to optimize their capabilities. While hard drives offer plenty of storage space at a low cost per megabyte, their rotating parts and small buffering systems are too slow to keep up

with the processor's need for input. Because DRAM is solid state (with no moving parts), it can send data as fast as the processor can keep up with it.

Although RAM is fast, it is also volatile. When it loses power, it has no way of holding onto the data it is storing. Therefore, you need to pull information from your slow but stable hard drives into memory, which then handles it at speeds fast enough for the processor to work with it.

Each byte of data is stored in RAM at a specific address, where it can be located by the processor when it's needed. The Macintosh writes information into RAM using a process called Cooperative Multitasking. This enables the DRAM to support multiple applications at one time, allocating portions of space to each program as it is opened. When an application is launched, it communicates with the Memory Manager to set aside a block of space in RAM for that application's needs. Within the space allocated to an application, there are two areas: the *stack* and the *heap*. The stack and the heap contain tools and application resources, as well as permanent and temporary file information. The stack and heap are constantly expanding and contracting, maintaining a balance between the data that a file contains and the application's tools you can use to modify it (see Figure 3.2).

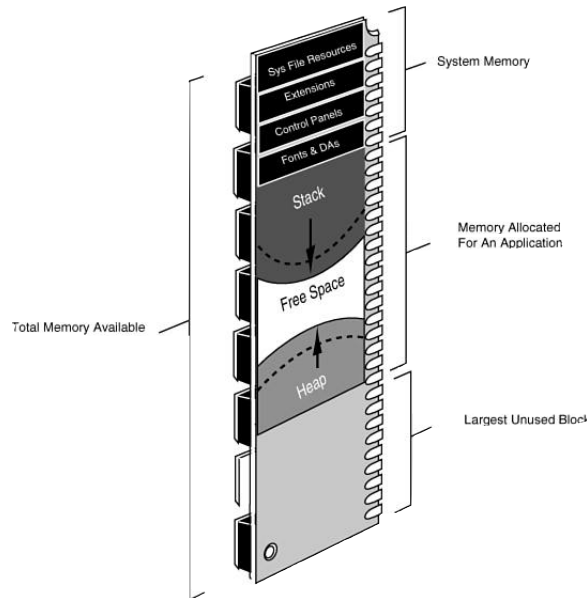

Figure 3.2

The stack and heap are in constant flux within an application's allocated RAM space.

RAM is an incredible tool that creates multiple spaces for applications and data, each of which continually expands and contracts as the data is juggled and manipulated. Not only is the activity within a RAM module extremely fluid, it also is very fast. The current components can transfer data at speeds of 60 billionths of a second. Keep all of this in mind the next time you're tempted to complain about the high cost of memory.

Allocating Memory to an Application

If you look at the memory usage graph in the About This Macintosh window (under the Apple menu), you will see a bar that corresponds with the memory allocated to the application. The bar is partially shaded, which reflects the amount of memory set aside for an application, and the amount actually being used. If you find that you are pushing the limit of an application's allocated memory, you should probably allocate more space to it.

To allocate memory to an application, highlight the application's icon, and select Get Info from the File menu in the Finder. At the bottom of the Get Info window you see recommended memory sizes, as well as a minimum size and a maximum size (see Figure 3.3). The minimum is the least amount of space you want allocated to the application. If you work with huge files in Photoshop, for example, you might not want it to open with less than 25MB of space, although version 3.05 can open with just 10.3MB. A large file would choke Photoshop with just 10MB allocated to it.

NOTE

The thing to understand is that it's the file size that determines how much memory you should allocate to a program, and the recommended sizes from the software developers often don't take into account the large files that designers work with.



Figure 3.3
The Get Info window for an application

While you're allocating memory in the Get Info window, notice that Apple's new implementation of Virtual Memory in the Power Macintosh has a significant impact on memory usage. This is an example of Apple taking a bad thing and making it better. When Virtual Memory was first introduced with System 7, it was not considered a good thing, especially for designers. As it existed then, virtual memory for the 680x0 Macintosh used portions of free hard drive space as RAM.

Designers at this time usually had more disk space than cash for RAM, so they assigned chunks of their hard drives as virtual memory. Their systems ground to a halt due to the slow process of writing RAM data to the hard drive and *then* to RAM. In those days, Virtual Memory swapped data between RAM and the hard disk, depending on, among other things, what application components were used most frequently. The old version of Virtual Memory became a safety net, enabling people to open things that they just wouldn't have had enough space for otherwise. Generally speaking, most people just shut off Virtual Memory, and to this day, the feature has something of a bad name.

With the dawning of the Power Macintosh, however, things changed. Power Macs are able to take advantage of a feature within Virtual Memory called File Mapping, which significantly reduces the amount of memory necessary to launch a native application. File Mapping requires less of an application to be loaded into DRAM at startup, loading the remaining components on the fly as they are needed. Virtual Memory also enables DRAM to understand that an application's code is always read-only, and does not need to be written back to the hard disk, which speeds the loading. The result is that Virtual Memory in a Power Mac, even with no disk space allocated to it, enables applications to load faster, while using less space (see Figures 3.4 and 3.5).

RAM Doubler... Creates way too many troubles to really be worth it.

RAM Doubler is no replacement for the real thing, but in a pinch there is nothing better. I tend to crash more frequently with RAM Doubler on, and it is a pain to have to restart twice to turn it back on after having it disabled. Other than those minor gripes, I would have not been able to crunch some of those monster Photoshop files.

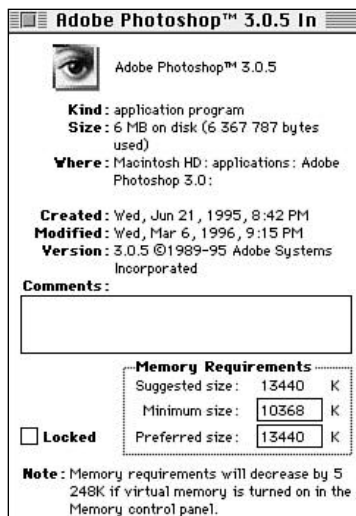

Figure 3.4
An application's memory requirements before Virtual Memory is turned on

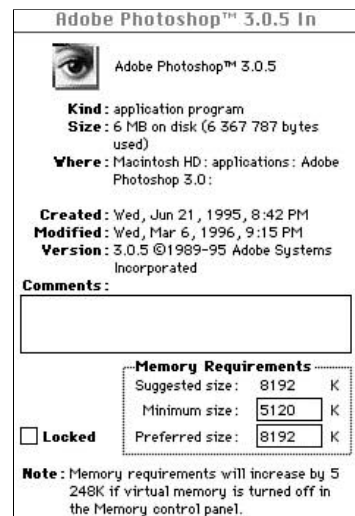

Figure 3.5
After Virtual Memory is enabled, the memory requirements for the application decrease significantly

The Memory Magicians

If ever there was an industry that thrived on innovation, it is the computer industry. To me innovation is nothing more than someone who sees a specific need in the marketplace and comes up with a unique and clever way of addressing that need. So it was in the memory arena. The basic problem is that many people don't have the budget to shell out \$1,500.00 for 72MB of RAM, especially after buying that Power Mac 8500, two page color monitor, accelerator card, and 4-gigabyte hard drive. If someone could figure out a way to give these people some relief from their memory deprivation, *and* not charge them an arm and a leg, they would certainly get a lot of attention.

A couple companies have done just that, and they are getting a lot of attention. One company is Connectix, makers of a software product called RAM Doubler. RAM Doubler does not actually double the amount of RAM that you have. (If it did, it would certainly sell for more than \$60.) RAM Doubler operates using the same file mapping technology used by Apple in its new Modern Memory Manager, which means that it is only effective on Native Power Mac applications. The advantages of RAM Doubler over Apple's Virtual Memory implementation of File Mapping are that you see some degree of performance increase with RAM Doubler, and that RAM Doubler frees up to twice as much additional memory as what is installed. Do not be deceived by the name, however, because you still need a decent amount of RAM for RAM Doubler to be effective.

Competing with Connectix is a company called OptiMem, makers of the RAM Charger. RAM Charger also juggles memory allocation, taking it back when an application isn't looking, and moving it to where it's needed. A key difference is that OptiMem does its magic apart from the File Mapping techniques associated with Virtual Memory. This means that it is effective even on older Macs that don't utilize System 7's Virtual Memory, as well as on applications that are not Power Mac native. RAM Charger also claims to organize resources better than Apple's Modern Memory Manager, avoiding system errors and allocation problems. RAM Charger also is effective for monitoring the status of your memory usage, giving advanced warning when memory is running low. RAM Charger has a convenient floating palette that keeps you abreast of memory allocations at all times, enabling you to make modifications on the fly.

When looking at products like these, it is important to understand the role they play. While they do a good job of managing the resources that you have, they do not replace resources that aren't there. This means that if you need memory, bite the bullet and buy the memory. RAM Doubler and RAM Charger will not help you open a 70MB file in Photoshop if you only have 8MB of RAM in your system. These software utilities are extras, adding some percentage of functionality to the main job performed by the RAM itself.

Every single night I get down on my knees and humbly thank Connectix for this wonderful product.

Couldn't live without this even with 20MB. I am upgrading soon and will be adding much more RAM, leaving RD behind on my personal computer—I run a lab of 40 Macs, all of which use RD and will continue to do so.

Ratings

RAM Doubler	1	2	3	4	5
Ease of Use					
Great Features					
Coolness					
\$ Value					
Overall Rating					

How Does RAM Impact Performance?

When you allocate more memory space to an application, the Memory Manager clears a larger space in which to work. Consider the analogy of a basic workspace, such as a drawing board. When you allocate more memory to an application, you create a larger drawing table for your work. This means that you can lay out more of your project at one time and work all at once. Also, you can have more tools, such as markers, brushes, straight edges, and pencils at your elbow.

If your table is smaller, you might have to go over to the counter when you need a specific tool, or file some pages away before you get any more. This process of putting away and getting out is very slow. If your space is extremely small, you might find that tools and artwork are just too close together, and that your space is cluttered. When this happens, things slow down even more, and you run the risk of spilling, tearing, or smudging the work due to the close working quarters.

As it is with the drawing board, so it is with RAM. Allocating more RAM gives the stack and the heap more room to operate. The first thing they do is open more resources from the application and display as much file information as possible. With less space, the Memory Manager has to continuously shuffle information from your drive to RAM as it is needed. This shuffling is a slow process, but that's not the whole picture.

When a large amount of space is allocated to RAM, the Memory Manager spaces out the various components throughout the RAM stack, which avoids fragmentation. More RAM enables the Memory Manager to keep larger blocks of memory open, which is all the more critical when working with large files. When working with smaller amounts of memory, the RAM space can become fragmented more quickly.

NOTE

Fragmentation is when the RAM stack forms pockets of unused space as various resources are plugged into and pulled out of the stack. It results in RAM having lots of smaller open spaces, but nothing big enough to support a larger file.

Avoiding Crashes

Some say that system crashes are a part of life on a Mac, and that is why we should save often and be patient. When crashes happen, we usually lose all of the data we were working on, back to the previous saved version. This is a clue that points us to a very important axiom for working on the Macintosh.

Almost all system crashes originate in memory, and almost all memory-related crashes can be avoided if there is more RAM.

These errors occur in a number of ways. The stack can become too large, expanding into the heap and crashing the application. Also, two applications can lay claim to the same RAM address, which results in a system error. Although the Memory Manager segments RAM for each application, those segments are not cast in stone, and applications can overlap at times. Giving each application enough space, or working in fewer applications at one time, will significantly reduce RAM-related system crashes.

How Much RAM Do I Need for Specific Applications?

Perhaps you're getting the idea that working with RAM is not an exact science. The truth is that it *is* an exact science; however, it happens to be too exact for most people, including me. Although an application is loaded into RAM when it's launched, it is only partially loaded, with the remainder coming in as it is needed. In addition, the values of the actual file data, contained in the stack, consume a large or small amount of space based on the file size. This file data expands and contracts within the allocated application space as calculations are performed. This makes it difficult to say, "If you are working on a 10MB file in QuarkXPress, you should allocate 23.7MB of RAM to the application."

Although I can't get that specific, I can make some solid general statements about memory usage. What follows is not meant to be a scientific formula. It is just common sense, tempered by the fact that it is better to err on the side of excess. Begin with the required memory size of the application. Say that an application, for instance, lists a suggested memory size of 5MB. Next, consider the average file size you will be working with, let's say that's another 5MB. So far, you've consumed 10MB for application and data. Now add another 5MB to cover any undos and general working issues. Out of the box, you're at triple our standard file size, and you're not done yet.

You then should consider how much work you will be doing in the application. Are you going to just open a file, crop it, and close it, or are you embarking on a long creative process, where pixels and vectors are going to see more than their share of juggling? As you really push an application, using a wide range of its capabilities and functions, the RAM is constantly moving various application resources in and out of memory. As we dis-

I wish designers, et al would stop whining about the insufficiency of software and hardware and be thankful for the creative opportunities current technology has given for exploration and imaginative expression. Not to mention the ease of the mundane, (such as eliminating keylining) and the ease of the once-expensive (scanning photos for FPO, for instance). As designers we're problem-solvers, which just now happens to include exploring and expanding the limitations/boundaries of software and technology as tools to execute our creative vision.

Brian Sooy
Brian Sooy & Co,
Elyria, Ohio

cussed, this can lead to fragmentation, where the RAM has lots of smaller open spaces, but nothing big enough to support a larger file. If you intend to do a significant amount of processing, you should allocate at least another file size worth of space (5MB in this case), if not two file sizes. A real creative session with a 5MB file should then have 25MB allocated to it if you can spare it.

This is mainly to suggest how you should be thinking about memory allocation and is not cast in stone. Use the file size for the application, add the manufacturer's minimum requirements, and then consider how much work you will do on the file. You can use less, but your performance will suffer dramatically if there is not enough memory.

Types of Memory

Although the term memory almost always refers to DRAM-based system memory, other types of RAM also exist for the Macintosh. These types are usually set aside to perform specific tasks within the Macintosh. By paying attention to these special requirements, you can dramatically impact your system performance.

VRAM

VRAM stands for Video Random Access Memory. If you run your monitor from on-board video, you are using VRAM to control the information sent to your screen. If you use a separate video card, plugged into either a PCI or NuBus slot, then you do not have to worry about VRAM.

The first thing that VRAM does is look at the total number of calculations it must do to support your monitor. After it has figured this out, it tells you how complex each of those calculations can be. One unique thing about VRAM is that it can be read from and written to at the same time. This enables the video processor to write data to the screen while it is reading the next screen image.

Consider for a moment the amount of data required just to put an image on your monitor. Most monitors display roughly 72 pixels per linear inch of space. This means that a square inch of monitor space contains 5,184 pixels. A standard 13-inch diagonal measure monitor contains 84 square inches of space. Multiply 5,184 pixels per square inch by 84 inches, and you get 435,456 pixels on the entire monitor. (If you have a 19-inch monitor, you can almost double that amount.) VRAM must calculate a specific value for each pixel. This shows the sheer number of calculations that VRAM must support for an average monitor.

The next thing VRAM determines is exactly how complex each pixel calculation will be. The complexity of the calculation determines how many different shades of color can be shown for each pixel, which is referred to as bit depth. 24-bit color calculates 8 bits of color per pixel. Considering that each pixel contains a red, green, and blue pixel component, we must multiply each by 8 bits, which equals 24 bits of color information. The end result is 16.7 million different color variations for each of the 435,456 pixels on my 13-inch monitor.

You should buy only enough VRAM to support the display you are using. You do not gain any speed benefits by installing more VRAM than is required to get 24 bits of color information. To view 24 bits of color information, a two page display must run 4MB of VRAM. 2MB of VRAM is all that is necessary on a full page, or 17-inch display, and 1MB supports a 13-inch monitor at 24 bits.

Cache Memory

Cache memory is a special section of memory that uses fast static RAM chips (SRAM) and serves as a shortcut to enable the processor to access certain types of data at very high speeds. Data written to the processor from standard RAM can take as much as 180 nanoseconds counting the request, access, and retrieval. Cache memory enables frequently requested data to go into the processor in as little as 45 nanoseconds. Using cache memory dramatically improves the Mac's overall system performance.

You should not confuse cache memory with the Disk Cache setting in the Memory control panel. These are two different things. The Disk Cache setting refers to the Mac's capability to enhance the performance of your hard drive or CD. It allocates a portion of your main memory (DRAM) to the most frequently used sections of your hard drive. You need to experiment with the relative size of your disk cache to optimize performance, because setting it too large can create additional overhead and actually decrease the performance of your system.

Cache memory exists as a buffer between the processor and the standard DRAM modules. The most recent instructions and bits of data are stored in cache memory. When the processor looks for information, it first looks to the cache segments and then to main memory (see Figure 3.6).

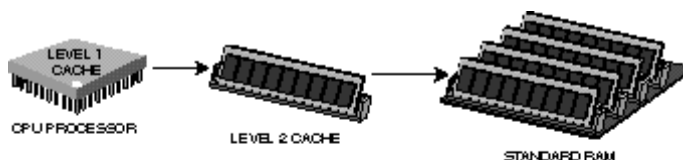

Figure 3.6

The processor looks to cache memory first and then to RAM.

Your system actually has two types of cache memory, called level one and level two cache. Level one cache, also called internal cache, is located inside the processor chip itself and is obviously not modifiable. Level one cache typically ranges from 1KB to 32KB in size, depending on the age and speed of the processor. The Power Macintosh 601 chip, for example, has a 32KB cache inside the processor itself.

Level two cache is located outside of the processor, either on the system board or on a modular cache card. The general rule of thumb says that for smaller amounts of RAM (up to 24MB), you should use 32KB of cache for every 1024KB of DRAM installed. This equals 256KB per 8MB, or 768KB per 24MB. This usually gets rounded up to 1024KB, at which point it remains constant.

How Much Speed Will a Cache Card Give Me?

Cache cards can affect a number of areas in your system. The most obvious one is the processor area, given the basic way that cache memory works. In addition, if you are using on-board video, you will find that screen redraw and QuickDraw functions can increase due to an increase in cache memory.

Using 256KB of cache, you can expect to see approximately a 30 percent increase in the performance of processor and video functions, as they pertain to imaging and graphics tasks. This number jumps to almost 50 percent with 1024KB of cache. Going beyond 1024KB seems to yield diminishing returns, especially compared with the increases seen with the first 1024KB of cache installed.

One point to keep in mind is that if you are going to use a cache, be sure you have enough of it, because a smaller cache segment stores fewer instructions in reserve. Because the processor always looks first to the cache before turning to the main memory, you can suffer something of a performance hit if the processor repeatedly finds nothing in the cache area. It is looking in two places instead of one, which can result in as much as a 25 percent decrease in performance. A sizable cache, however, will yield the performance gains listed above. For this reason, my recommendation is that if you are going to use a cache, bump it up to 1024KB, and optimize things right out of the box.

PC Cards

PC cards are also known as PCMCIA Cards and refer to a specific type of interface developed by the Personal Computer Memory Card International Association. Some people joke that PCMCIA stands for People Can't Memorize Computer Industry Acronyms, which might be why the term has been shortened to PC card in the last year or so.

PC card slots are appearing in notebook computers (such as the PowerBook 5300 series), digital cameras, Apple Newtons, and even in individual desktop readers. PC cards are inserted into the PC card slots provided by the host device, giving the device extremely fast access to the card's contents.

PC cards come in three flavors: Type One, Type Two, and Type Three cards. All three card types measure the same length and width and use the same 68-pin connector. The only physical difference between the card types is thickness. The thicknesses are 3.3, 5.0, and 10.5 millimeters for Type I, Type II, and Type III cards, respectively. Because they differ only in thickness, a thinner card can be used in a thicker slot, but, of course, a thicker card cannot be used in a thinner slot.

Each card has features that fit the needs of different applications. Type I PC cards typically are used for memory devices, such as RAM, Flash, OTP, and SRAM cards. These are static memory cards that come in capacities ranging from 5MB to 40MB. The cost per megabyte is usually quite steep compared to other memory types, but they do have their advantages that can justify the cost. Since they are static memory devices, they deliver throughput performance that is much faster than any hard drive. In addition, because they are a form of SRAM design, they are able to hold their contents even when power is removed. Thus, they are an extremely portable way of transferring data from system to system. Most digital cameras use Type I cards to record their images. They can then be transferred to a CPU or Apple PowerBook that has a PC card reader.

Type II PC cards are typically used for I/O devices, such as data/fax modems, LANs, and mass storage devices. These are the thin fax modems that people use with their laptops. Technically, they are not memory, but I mention them here just to clarify what PC card technology has to offer.

Type III PC cards are used for devices whose components are thicker, such as rotating hard drives. The primary use for Type III is rotating media with high capacities, currently at 340MB. (They should be up to 500MB by the time you read this.) Some manufacturers also have built pagers into Type III cards, which interface directly with the computer.

...keep it off the technoid stuff. What we do is design, not "work with computers," as my friends say.

Dave Shaw

Digital Photography Embraces PC Card

The digital photography industry has fully embraced PC card technology as their media of choice for recording images. These small Type I and Type III cards interface directly into almost all top digital cameras, including offerings from well-known companies, such as Nikon, Fuji, Kodak, Minolta, and many others. Photographers record photo images directly to the cards, where they appear as digital information to be read by the CPU.

continues

continued

Microtech International offers a SCSI-based desktop PC card reader, called the Digital PhotoAlbum, that accepts Types I, II, and III cards, and reads them directly into the Macintosh itself (see Figure 3.7). This addresses what was once a missing link in the digital photography process. Now, photographers can capture images with their cameras and see the images on their desktop in a matter of seconds. The digital PhotoAlbum is a two slot reader that even transfers data between cards, as well as to a system's hard drive. Microtech also manufactures a handheld PC card reader, called the Digital PhotoAlbum, which has a single slot and is designed for portability.

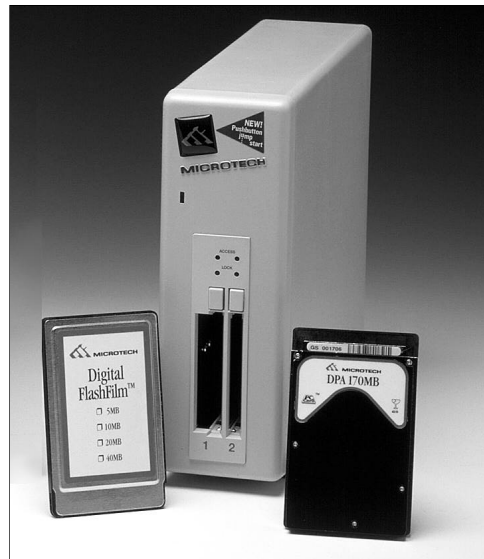

Figure 3.7
Microtech's Digital PhotoAlbum,
with Type I and Type III PC
cards

How to Purchase Memory

For a designer or imaging professional, purchasing memory is probably the greatest single component expense in your system. With all of the thousands of dollars that people spend on it, it amazes me that they are not more discriminating where they purchase it. The general misconception is that all memory is exactly the same, and that as long as the capacities are equal, you should just take the cheapest price.

The first thing to realize is that all memory is not created equal, and that it's critical that you purchase modules that are well made and can deliver the speeds required by high-end imaging systems. The second thing to understand is the value that your memory supplier builds into the product. Although you want to pay for additional quality or service, it is throwing money away to pay more to someone acting as a middleman, and who serves no purpose but to add on an additional 10-25 percent in cost.

Begin with the Manufacturers

There are some great memory manufacturers out there who do the right thing in making memory that works. These are companies that work closely with Apple as new machines are being developed, and make sure that all of their modules are built to Apple's spec. When you buy modules from companies like Kingston, Microtech, and Newer, you know that there will be no surprises when you install them.

Manufacturers also tend to support their products better than a broker or other memory middleman. They usually offer a lifetime guarantee, and have knowledgeable personnel who can answer specific questions about installation and applications. One thing that I have learned over the years is that it is important to build a relationship with a vendor, and to take advantage of their expertise. Each of the companies I mentioned above has been in business since the early eighties, and they know how to support the Macintosh community.

Manufacturers may be a little higher in price than a broker who's looking to unload some inventory quickly. In this case however, the extra price is probably worth it, given the development and support that comes with doing business with them. In addition, they are savvy in the memory marketplace, and over the long haul, they may be more competitive.

What Is a Memory Broker?

A memory broker will never advertise himself as such. This is someone who builds little value into the product, and is looking simply to mark it up and move it out. It can be difficult to distinguish between a broker who does nothing to the product, and a small but dedicated memory company looking to make its mark. Memory brokers often advertise in the back of magazines, with extremely low prices plastered across the top of their ads.

Because there is very little regulation over levels of quality in the memory business, it is difficult to know exactly what you are buying. If someone told you that you were buying four-layer 60ns non-composite chips, when you pulled them out of the box, could you tell if they were or not? Not only that, but when you installed them in your machine, you probably wouldn't notice the difference right away if they were substandard products. It is only over time that the problems come to light, and that could leave you six months older, and a few thousand dollars poorer, as you look at a system with a Sad Mac on the screen.

I don't mean to make it difficult for the upstanding and legitimate companies that do advertise in the backs of the books, but the reality is that when I go to spend money on RAM, I need to know that the company is selling me a legitimate product, and that it will be around next year if I have a problem with it.

Catalog Houses...The Hybrids

One of the fastest growing marketing tools for the computer industry has been catalog sales. Macintosh-based catalogs, such as Mac Mall, Mac Warehouse, and Mac Zone, have built a very popular business model that many are rushing to emulate. They base their success on very good prices, a one-stop shopping approach, and very good service. I like buying things, such as modems, software, and other components through them, because they have a great selection, and my order usually arrives the very next day.

In following the one-stop shopping model, it is not surprising to see Mac shopping catalogs selling memory. They list all of the upgrade options and aggressive pricing and they have that person at the other end of the phone to walk you through basic questions and to ship your order right away.

Catalog houses are something of a hybrid between the memory manufacturer and the memory broker. They certainly do not manufacture their own memory, and they are adding a layer of cost to the product as they handle your order. On the other hand, they are convenient to use, and you have a little more assurance that the company will be in business long term. In addition, most of them do offer the same solid guarantees and warranties that the manufacturers do.

Installing Memory

Installing memory is a fairly simple process, as long as you follow a few specific rules. Each machine has its own design in terms of how many RAM slots the machine has, as well as where they're located. You should consult your manual for this information. The following point should always be adhered to when installing memory in your machine. (This goes for NuBus and PCI cards as well.)

Preparation

- Set the Mac on a hard, uncluttered surface, in a non-carpeted area.
- ALWAYS* wear a static wrist strap when handling memory.
- Make sure that the Mac is unplugged and that all cables are disconnected before removing the cover.
- When uncovering your Mac, don't force the cover. If it's not lifting off, make sure that it's not caught on something, or that you haven't forgotten a screw.

Installation

- DIMM modules are held in place with friction only, as opposed to SIMMs, which use clips.
- Firmly insert DIMMs in place, making sure that the module is flush and that all the pins are connecting.

Finding a Good Price

I think that the way to determine where you should buy memory is first to temporarily eliminate the price issue. Ask yourself, "If all pricing issues were equal, where would I want to buy my memory?" That is a question for you to answer, but for my money, I would prefer to buy from the manufacturers. They have the most knowledge of products, and more importantly, they are able to test and evaluate products to ensure that they are up to spec.

Whatever source you choose, you then have to add price back into the mix. In general, the adage that if a deal seems too good to be true it probably is, certainly applies here. The memory market is a sophisticated one, and if someone is selling at an outrageously low price, there has to be a reason for it. Be wary of deals that are way below what everyone else is charging.

When you have a few prices in your hands, you should see some sort of delta, usually differing in a range of 20-30 percent. Armed with these quotes, you then should approach the memory source you decided on when price was not a factor and see if they will play ball.

Many manufacturers sell through dealers, as well as selling direct. What I would do in buying from a manufacturer is call them directly and see how they will sell to you. If they say that they must go through dealers, ask them who their highest volume dealer is in your general region. Then, call the dealer and tell him your situation. You have all of these other prices and

- When inserting and removing memory, take special care not to place any flex on the motherboard. This could result in a cracked board, which in effect would "total" your system.
- After the memory is installed, plug everything back in, restart your system, and open the About This Macintosh window under the Apple menu. The amount of memory in the Total Memory section should reflect the additional RAM you just installed.

Troubleshooting

- If the memory does not show up in the window, reopen the machine and make sure the modules are seated firmly in the slots.
- If reseating the modules does not resolve the problem, or if you get any kind of Sad Mac or chimes on reboot, pull the new modules out of the machine, and attempt to reboot with your original memory. If you reboot successfully with your old memory, return the modules you just purchased for replacement.
- If you reinstall your old memory and you still get a Sad Mac or chimes, take your machine to your dealer for diagnosis.
- If you are at all tentative about the installation procedure, go to your nearest dealer and shell out the \$50-75 to have them do the installation. It's better to pay the extra 5 percent than to do any damage to the machine or the memory.

(assuming that they are lower than his), you want to know if they will match the price. Be careful about giving them bogus pricing, because these guys know the market very well, and they know if you are lowballing them. Also, the reality is that they are in business to make money, and there is only so low they can go. Having said that, my experience is that if you find a dealer who sells memory in high volume, they are more likely to dicker with you. If you get close to the low price from another company you never hear of, go with the manufacturer/dealer option. This way, you have both a local and a national vendor that you can go to if problems arise.

Going through catalogs is a little tougher to do, although at times they may be the low price already. Try to use the same approach with them, that you will buy their product if they can meet your price. One general note is that if a vendor meets your price as you have asked him to, follow through and buy the product from him.

Brokers are the most likely group to dicker with because their number one marketing tool is price. If they can't win a deal on price, they usually don't win it. Telling them that you have other prices and you want to know how they compare is the only way to approach a broker. In addition, the onus on the broker is to actually beat your best deal, not just to match it. If a broker gives you the same kind of price as Microtech or Mac Mall, go with the established vendor.

Basic Memory Questions to Ask

As in buying a car or making an investment, when buying memory you really want your vendor to know more than you do. Asking the following questions will not give you all of the information you need to make your final purchase decision, but it will weed out the companies that you should avoid. If a potential vendor can't answer these questions satisfactorily, then you should stay away from them. These questions set a bare minimum criterion for product quality as far as memory is concerned.

Is It Composite or Non-Composite?

These terms are getting a little old at this point, but since they are still being tossed about, you should be aware of the distinction between the two. Composite modules appeared on the scene while Apple was transitioning beyond the standard 8MB modules, to the 16MB and 32MB varieties. Some memory vendors were trying to squeeze lots of 4MB chips onto the board to make up a higher capacity module. Doing this created what the industry called a composite module. Composite modules were problematic in that they didn't conduct heat very well, as well as the fact that the modules were not very sound from an engineering level due to the way that so many chips were squeezed onto one board.

Non-composite modules are the preferred choice, in that they use 16MB chips, which avoid the associated composite problems. If you are buying modules smaller than 8MB, you do not have to worry about composite modules. If you buy modules that are 16MB or 32MB, you should simply count the chips on the board. If there are only 6-8 chips per side, then you're OK. If there are 16-24 chips on each side, then it is composite, and you should send it back if you can.

What is the Refresh Rate?

The refresh rate of a module tells you how fast it is. This directly impacts not only the performance of your system, but it also determines whether the module will even work in your system. Therefore, you should know the required refresh rate for your Mac.

The original Mac Plus, SE, and Classic used RAM modules with refresh rates as high as 150ns. These numbers slowly edged down around the 120ns mark with systems like the Mac II and the Mac IIci. Starting with the Mac IIci, the speed dropped to 80ns, which is where it is hovering even today. Some of the new Power Macs use 70ns DIMMs, and the Apple WorkGroup Server 60 actually uses 60ns modules. Be sure to check the speed that your system requires before you place any memory order.

What is the Board Thickness?

Memory boards come in either two-layer or four-layer thicknesses. This means that the four-layer boards have twice as many layers of plastic used in their construction. The importance of using four-layer boards revolves around the issue of heat. As memory is used in your Macintosh, the RAM gets very hot. As a module heats up, the two-layer boards can warp and bend. In addition, the constant heat up and cool down caused when a machine is turned off and on actually expands and contracts the module. Over time, the two-layer modules can break down as their traces become worn, or the boards themselves begin to crack.

What is the Warranty and Guarantee?

You want to find a company that offers you a 30-day return policy, as well as a lifetime warranty. This means that you can install the product and make sure that it works within the first 30 days. Even the best companies have products damaged during shipping, but if a company can't get their stuff to work in 30 days, then forget about it. You should send the product back at this point, and they should refund your money.

The warranty simply says that if the memory fails at any point, you are eligible to return the product for replacement. If it's well built, memory seldom fails, so this is not a big risk on the memory vendor's part. Besides, the way technology keeps changing, a lifetime warranty really amounts to a 4-6 year warranty, even on the most advanced machines. Beyond that amount of time, your system will end up in a museum anyway.

Taming Your Fonts

Apple introduced many innovations in the Macintosh, most of which have slowly permeated into other computer platforms. One technology that the Macintosh introduced in 1984 was called WYSIWYG (whizzy-wig). WYSIWYG is an acronym for What You See Is What You Get, and that's exactly what it means.

Before Macintosh, any font or typestyle applied to text in a computer was in some form of tag, much like HTML today. Something written in Times, for example, would begin with a tag indicating the font choice. A selection made bold would be encapsulated in a pair of bold tags indicating the start and end of the bold text. Only when the text was printed would the fonts and styles be visible.

The Macintosh was the first computer that displayed on-screen exactly what the printer would print. Text would be displayed in Times if that's the font you put it in. Bold text would be noticeably darker than regular text. What you saw on-screen was what you got out from the printer, hence WYSIWYG.

Since then, of course, all personal computers have adopted similar systems, but Macintosh remains the leader in typography, nonetheless.

If you want to know...

Go to...

How do I install fonts?	70
What is the difference between Type 1 and TrueType fonts?	71
What are multiple master fonts?	73
What is QuickDraw GX?	74
What is a font ID conflict?	78
What are the best font management utilities?	75

Installing Fonts

Currently, there are two major types of fonts that you can install in a Macintosh: TrueType and Type 1. Other types of fonts, such as QuickDraw GX fonts and Type 3 fonts, are available but are not in widespread use. For now, you should know the various files necessary for each type of font. Later I'll get into the advantages and disadvantages of each type.

TrueType fonts are simple, one file contains information for screen display and printing. Type 1 fonts consist of two files. One file is a PostScript outline font. The printer uses the PostScript outline for drawing smooth text at any size and resolution. The second half of a Type 1 font is the bitmap, which is used for screen drawing. Typically, a Type 1 font comes with several bitmap versions of the typeface, each in a different size. Bitmaps are not scaleable like PostScript or TrueType, so multiple sizes are necessary to draw text on screen. You can draw a bitmap font at any size, but it looks blocky instead of smooth.

Sometimes bitmap fonts also are included with TrueType fonts. While bitmaps are not necessary with TrueType, they usually are more precise for screen drawing.

QuickDraw GX offers a portable document format that does everything the others do but will be built into the system when Copland ships. If you spend the extra memory on GX, you might want to include this format. Everyone has it, but it requires a restart to install and then deinstall GX.

Arne Quanbeck

System 7.0 Font Installation

Years ago, before System 7.0, installing fonts in the Macintosh was a pain. An application called Font/DA Mover was required for font installation and removal. Turning fonts on and off was hardly an option. System 7.0 made the process easy, doing away with Font/DA Mover entirely.

Under System 7.0, all TrueType and bitmap fonts belong in the System file. You can install fonts by dragging the TrueType and bitmap files directly onto the system. PostScript files belong in the Extensions folder. Dragging PostScript files to the Extensions folder will install them.

System 7.1 Font Installation

In System 7.1 and later, Apple made font installation even easier. Rather than scattering different types of font files around various areas of the System Folder, System 7.1 consolidated all font files into a single folder. Aptly named the Fonts folder, the new folder contains all the system's fonts, both TrueType and Type 1.

NOTE

Installing Type 1 fonts requires one more step, no matter which system you're running. You also need to have Adobe Type Manager (ATM) installed. Since Type 1 fonts are not native to the Macintosh system like TrueType fonts, ATM takes care of Type 1 font operations. If you already have ATM installed, Type 1 font installation requires only dragging the files to the appropriate section of the System Folder.

Installation is a matter of dragging fonts files into that single folder. Or, to make the process even simpler, you can drag font files onto the closed System Folder. The system will sort out where to put the files. It even tells you where the files have been placed when it finishes sorting.

Type 1 or TrueType?

If TrueType fonts are native to the Macintosh system and don't require additional software, what's the point of Type 1 fonts? Since Type 1 and TrueType fonts accomplish basically the same thing, smooth printing of text, it seems like a legitimate question. And it is a question that is hotly debated among designers and typographers.

Each font type has its own strengths. Type 1 fonts are excellent for printing because the shape is defined by a mathematical curve. The high resolution of a printer produces a very accurate representation of that curve. TrueType fonts are better on-screen because of superior hinting controls. *Hinting* is a process by which the type designer can control how the font scales at low resolution. Because screen resolution is relatively low, TrueType fonts display well at almost any size.

Conversely, Type 1 fonts don't hold up so well on-screen because they rely on bitmapped versions for screen display. If you don't have a bitmap version of the size you need, a Type 1 font won't display well. TrueType fonts' strength lies in on-screen drawing; TrueType printing suffers as a result. Many designers report errors and misprinting when using TrueType for print work.

So, which type you use generally depends on what work you're doing. For print work, you'll probably want to be using Type 1 fonts. Multimedia producers and others whose work ends up on-screen may have better luck with TrueType. Of course, if the font you need isn't available in the type of font you'd like to use, you may have to look at the alternative type.

Styling Type

Many books offer advice on how to use fonts: when to use serif fonts, when to use heavy fonts or light fonts, how to do headlines. Such information is useful to a point. In the end, though, the font to use, the spacing and kerning, the font weight and style, serif or sans serif, are up to the designer. It's your decision, as an artist, to make the work look a certain way. You're the designer, and I'm not going to tell you how to design. Instead, this section will focus on what various type elements are and what to watch for when using them.

Type Styles or Styled Type?

Since day one, the Macintosh has had a number of options built-in for styling text. Styles such as italics, bold, underline, outline, and shadow are available to all fonts. Most applications have dropped the use of the

NOTE

If you are interested in more information on using type, *Stop Stealing Sheep & Find Out How Type Works* by Erik Spiekermann and E. M. Ginger is a fantastic resource. The book explains type and typography in clear, concise terms and in far more detail than is possible here.

outline and shadow styles, and have added their own styles such as small caps and strikeout. These styles are all modifications applied to a font to give the text a different look. Some of the styles aren't quite accurate, though.

Compared to a plain font, a properly styled font is actually significantly different. Italic fonts, for instance, are not just a slanted version of the original, as is the italic style provided by the Mac OS. In fact, the slanted text created by applying an italic style to text is more accurately called oblique, not italic. And while bold text is a fattened version of the original font, a real bold font has changes in each character which make the heavier text more legible.

The Whole Mac
 The Whole Mac
The Whole Mac

Figure 4.1

Real italic text involves more than just slanted text. This text demonstrates roman, or plain, text, the system's italics, and a proper italic version of the same font.

Although the Mac's built-in styles are quick and easy, they don't look as good, nor are they as accurate, as a properly styled font. Whenever available, use the styled font instead of the Mac's font styles. Most commercial fonts come in a variety of different styles. And, if the available fonts aren't exactly what you need, take a look at what customizable Multiple Master fonts can do for you.

Kerning Text

Setting type is more than just choosing a font and size. It's important to control the way text flows on a page. By using kerning, you can tighten text, making it look more natural.

Kerning is a process by which character pairs are moved together or apart as needed to make the letters fit better. The letter pair "To," for example, can be kerned so that the 'o' sits under the 'T.' Punctuation can be moved closer to letters and space between words can be decreased.

Many sophisticated word processors and page layout programs have automatic kerning features. Some applications also provide a means to manually kern text. If you choose to kern manually, make sure the kerning is consistent throughout your document. No kerning is better than uneven kerning.

The Whole Mac The Whole Mac

Adjustable Fonts

Before Type 1 and TrueType, there were only bitmap fonts on the Macintosh. For every point size you wanted, you needed to have a corresponding font. To get Times 12, 24, and 36, for instance, you needed three files: Times 12, Times 24, and Times 36. Type 1 and TrueType changed that by making it easy to scale a font to any size. Type 1 and TrueType were still bound by style and weight, though. Multiple master fonts have broken that boundary.

A multiple master font works like this: each font contains one or more design axes. A *design axis* controls some aspect of a font, such as weight, width, or style. By adjusting these axes, a multiple master font can range from extra light to extra bold, condensed to wide, san serif to serif, or anywhere in between. Adobe Type Manager 3.9 even enables you to make these changes directly in the ATM control panel and save each new iteration of the font. Before ATM 3.9, a separate program called Font Creator was needed to make new multiple master variations.

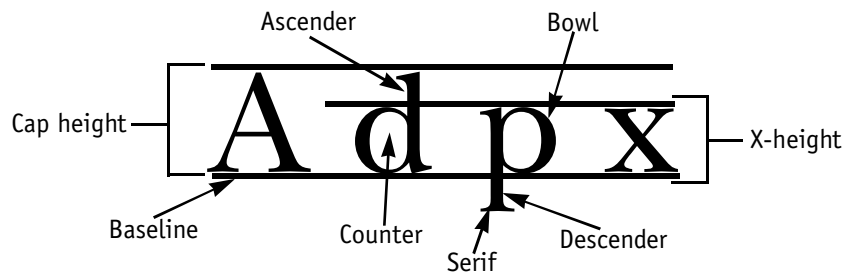

Figure 4.3
The elements that make up a character.

These elements are the following:

- Ascender**—The portion of a character that extends above lowercase characters. The letters *d*, *b*, *h*, and *k* all have ascenders.
- Baseline**—The line along which the bottoms of all characters are aligned.
- Bowl**—The round section of characters like *p*, *q*, and *d*.
- Cap Height**—The distance from baseline to the top of all capital letters.

Figure 4.2

Kerned text looks good and saves space, too. The kerned letters in the second line fit together better, resulting in a narrower line of text.

NOTE

Multiple master fonts have one drawback: large memory requirements. Because of the complexity of multiple masters, Adobe recommends at least three megabytes of printer memory.

- Counter**—The white space inside characters such as *b*, *d*, and *q*.
- Descender**—The portion of a character that extends below the baseline. Examples are *p* and *q*.
- Serif**—Short, ornamental lines across the main strokes of a character. *San serif* is without serifs.
- X-height**—The distance from the baseline to the top of all lowercase characters.

QuickDraw GX: The Typographer's Dream

Apple is famous for introducing cool technologies that nobody uses. PowerTalk, Publish and Subscribe, and QuickDraw GX are great technologies that have been all but forgotten. QuickDraw GX, however, is just waiting to take off.

The problem with these technologies, the reason they fade out instead of becoming system standards like QuickTime, is that applications developers must support the technologies before they become useful. QuickDraw GX requires inordinate amounts of RAM to function, so developers are not quick to incorporate the technology into their applications.

If QuickDraw GX requires so much RAM, why should anyone *want* to run it? QuickDraw GX does just about everything a typographer could want. QuickDraw GX enables a designer to lay text with the same control possible in manual typography, with automatic kerning, ligatures, many of the features currently available in Multiple Master fonts, and more. With QuickDraw GX, you can make text look exactly the way you want with precision and accuracy unparalleled elsewhere in digital typography.

If you have the RAM to spare and have applications that support QuickDraw GX, I recommend using it. Not only is QuickDraw GX more powerful than any other font tools, it is about to become the standard. With System 8, Apple has incorporated QuickDraw GX into the OS. Once developers know that more users have QuickDraw GX installed, they will be more likely to support it in applications.

Organizing Fonts

The Fonts folder is possibly the most disorganized area of the System Folder. A single folder contains every font in the system and each of those fonts may be comprised of several files. Separate files are used for different sizes of bitmap fonts and different styles of any font. To make matters worse, the Fonts folder is limited to 128 items. You have to fit all the fonts you'll need into that space. Fortunately for designers (who typically need a lot of fonts), there are several solutions available.

Font Suitcases

The Macintosh provides one method of font organization already. Called suitcases, these handy, folder-like items can contain a number of TrueType and bitmap fonts. PostScript Type 1 fonts cannot be stored in suitcases, but also are not restricted by the 128 item limit on other fonts. Ideally, all bitmap and TrueType fonts should be stored in suitcases; they're less likely to become damaged when stored in a suitcase.

Organization of fonts in suitcases is usually limited to font families. Suitcases cannot be nested hierarchically, which limits their organizational value. Typically, all styles and sizes of a particular typeface will be stored in a single suitcase. For more powerful organization, several font management utilities are available.

Font Management Utilities

Most font management utilities do more than just organize fonts. Including useful features like conflict resolution, automatic enabling and disabling of fonts, and the capability to store and organize your fonts any way you choose, font management utilities are almost a requirement for creative professionals. As with any software, font management products that specialize in one area tend to excel in that area.

Symantec's Suitcase 3.0 is the industry standard for font organization. Suitcase enables you to store fonts anywhere, organize them in any fashion, enable and disable fonts any time, and includes some basic font conflict catching. Suitcase even enables you to attach sets of fonts to particular applications so that those fonts will be automatically enabled when the application is launched. If you use many fonts, you need Suitcase. (And if you use a version prior to 3.0, upgrade! 3.0 is leaps and bounds ahead of older versions.)

You can tell how well a studio is organized by their fonts. A good amount of problems that plague designers' projects are related to not knowing how to control the fonts. Fonts also have a tendency to grow as the studio grows. Legally purchased font licenses cover only five computers and one printer at one site. It often happens that fonts "migrate" from other places. I cannot stress this enough; the best policy is to remove any migrated fonts. I have been to too many studios where I have to spend several hours straightening out thousands of fonts. The more open fonts the more memory is used, and this slows down everything. Sometimes the system cannot load them all since there are so many.

Joseph Clark, AIGA
Springhouse Corporation
Springhouse, PA

Ratings

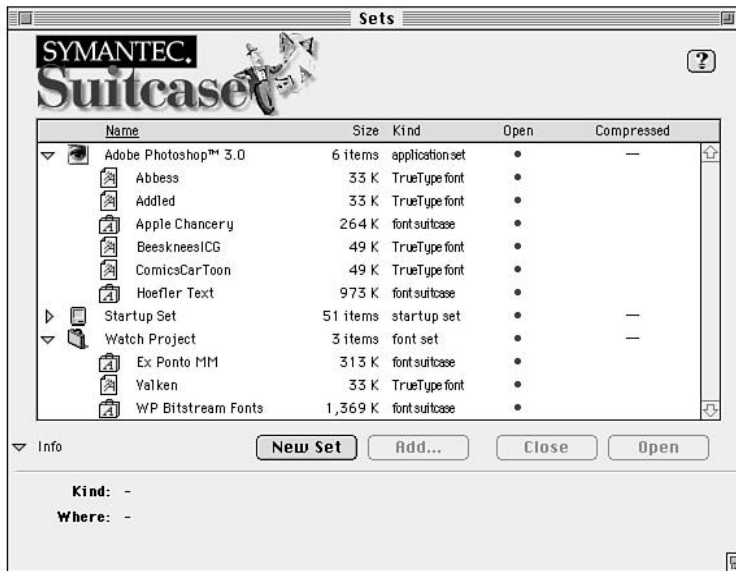
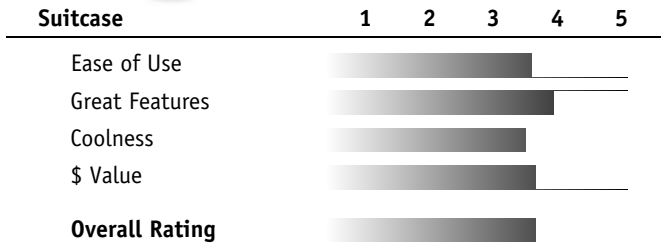

Figure 4.4

Symantec Suitcase's main window provides advanced font aliasing and organizing capabilities. Fonts can be grouped into sets and assigned to specific applications or loaded manually when needed.

In direct competition with Suitcase, MasterJuggler from ALsoft, provides many of the same features. But while Suitcase specializes in fonts, MasterJuggler also manages other system files such as sounds, Apple menu items, and Fkeys. However, recent versions of MasterJuggler have been focusing more and more on strict font management. ALsoft recently released the latest version of MasterJuggler. It is MasterJuggler Pro.

If Suitcase and MasterJuggler are not options, the shareware utility Fonts Manager, by Ed Hopkins, may be your solution. Fonts Manager doesn't use extensions or control panels, so it's less likely to conflict with other applications. Fonts Manager behaves more like an extension manager; it simply moves fonts around to enable and disable them. Unfortunately, it also shares the drawbacks of extensions managers; you have to restart the Mac for changes to take effect. It is, however, a quick and easy solution.

Ratings

MasterJuggler	1	2	3	4	5
Ease of Use	██████████				
Great Features	██████████			██	
Coolness	██████████			██	
\$ Value	██████████				
Overall Rating	██████████			██	

For font conflict resolution, Insider Software's Font Box is the best in the business. Suitcase and MasterJuggler both provide basic font conflict resolution, but aren't so adept at automatically fixing them. While both Suitcase and MasterJuggler can fix some problems, Font Box finds and fixes almost all font conflicts you might encounter, including the following:

- Font ID Conflicts.** The Mac OS identifies fonts internally using an identification number. Because there are more fonts than ID numbers, conflicts arise. Font Box renumbers all fonts in the system, eliminating conflicts.
- Font Name Conflicts.** Font ID conflicts aren't always visible because applications refer to fonts by name. When two fonts have the same name, however, an application won't be able to tell which is which. Font Box renames or removes fonts with conflicting names.
- Duplicate Fonts.** Font Box has the capability to search an entire hard drive for fonts, not just the Fonts folder. So, if you have fonts hidden somewhere deep inside your computer, Font Box will find them. If you already have the font installed elsewhere, Font Box saves you the disk space by deleting the duplicate.
- Missing bitmaps and PostScript files.** Because Type 1 fonts require both a bitmap and a PostScript outline, Font Box makes sure you have both halves of every Type 1 font.
- Corrupt fonts.** Any time your Mac crashes, files that are open, including fonts, can be damaged. When a damaged font is opened, more crashes, and potentially more damaged fonts, are likely. Font Box scans for damaged fonts and reports or removes any offending files.

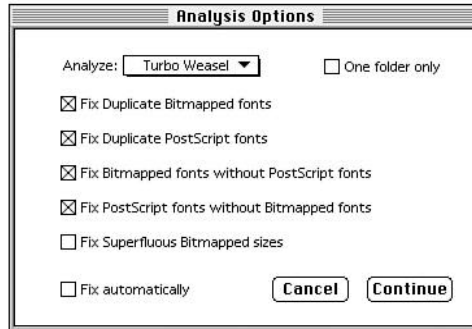

Figure 4.5

Font Box takes you through a series of options dialog boxes before beginning an extensive analysis of your current font setup.

Understanding Font ID Conflicts

You know what a font ID conflict is. If it's an internal error, is it something you need to worry about? How can you tell when a font ID conflict occurs?

Font IDs are integers assigned to fonts internally. If an application uses the ID to refer to fonts, errors can occur. Fonts may appear to switch; you select one font and get another. Or, when moving files to another machine, you may get the wrong fonts.

If your software is up to date, the chances are that you won't ever have trouble with font ID conflicts. Older applications, such as Microsoft Word 4.0, used font IDs. Because of the potential errors with ID conflicts, most applications now use font names as identifiers. And if two fonts have exactly the same name, they're most likely the same font. You can get rid of one file.

Manually fixing font conflicts and organizing fonts is close to impossible. The time required to investigate problems or shuffle fonts in and out of the Fonts folder, especially when many fonts are installed, is prohibitive. For organization, my vote goes to Suitcase. Font Box earns my vote for conflict resolution. I recommend getting one or both utilities. If both are not an option, Suitcase covers more bases and will take care of most common conflicts.

Adobe Type Manager 4.0

Although not yet available at the time of this writing, Adobe Type Manager 4.0 promises to include a number of functions currently only available in font management utilities such as Symantec Suitcase. ATM 4.0 promises font organization into sets, conflict resolution, and font sample printing so you can see exactly what your fonts will look like on paper. It remains to be seen whether ATM 4.0 can replace current font utilities or simply supplement them.

Indispensable Font Utilities

Some utilities defy categorization and yet are necessary additions to any designer's toolbox.

Organizing the Fonts Menu

Adobe Type Reunion, for example, is very simple: it organizes font menus into hierarchical menus, grouped by font family. Type Reunion makes font menus far cleaner, far more organized, and much easier to navigate. If you don't have it already and are still scrolling through endless lists of fonts every time you need to choose another, get Adobe Type Reunion. If you use Multiple Master fonts, which can have many instances, Type Reunion is invaluable.

Ratings

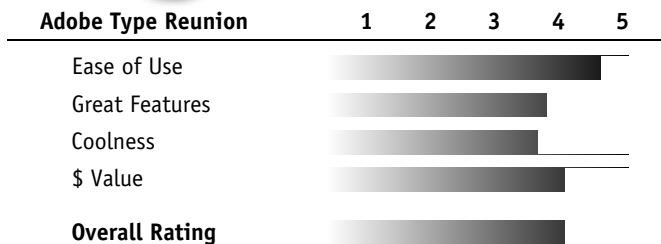

Ratings

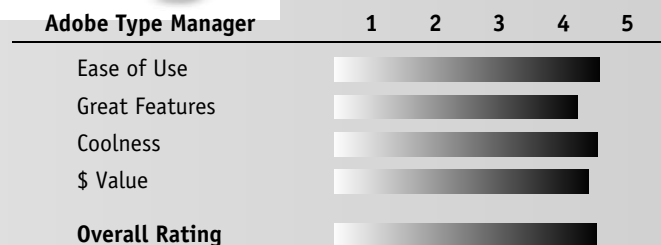

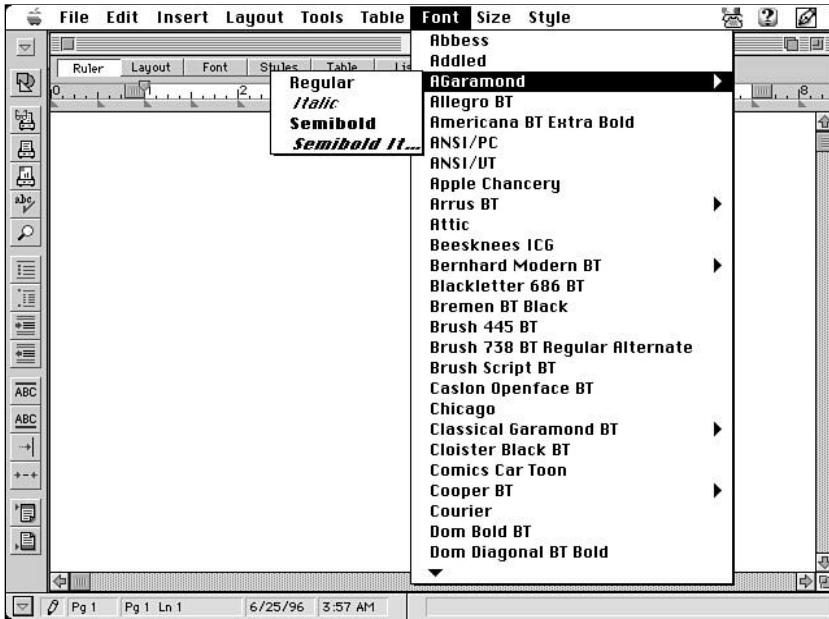

Figure 4.6

Adobe Type Reunion cleans up font menus by organizing font families into submenus.

Printing Font Samples

Another useful set of utilities are font sample printers. A program called theTypeBook, by Jim Lewis, and TypeIndexer, by Linographics, both provide printed samples of selected fonts in a range of different sizes. Such samples are absolutely essential in selecting exactly the right font for a job.

TypeIndexer has one unique feature that sets it apart from theTypeBook: fonts don't need to be loaded to print samples. With theTypeBook, only fonts that already are loaded can be printed. TypeIndexer makes it very easy to go through a CD full of fonts, select the ones you want to see, and get a printed sample without ever having to move or load the fonts.

Collecting Fonts

Finally, here's a utility for users of QuarkXPress and Adobe Illustrator. When files need to be sent to print, collecting fonts used in the file can be tedious at best. The fonts may be difficult to find, or you might select the wrong style or size accidentally. Font Sneak, from Deb Lake, makes the task easy.

Font Sneak does one thing: opens QuarkXPress, Adobe Illustrator, or plain EPS files, searches for fonts used in those files, and then collects those fonts together for shipment. If you want to be absolutely sure that printing works without a hitch and without any missing fonts, Font Sneak will let you rest easy.

WYSIWYG Menus—Font Utilities to Avoid

WYSIWYG menus are font menus that display the name of each typeface in the font. The name Palatino, for instance, would be written in the Palatino font. Apple Chancery is written in Apple Chancery. The problem with WYSIWYG menus is that not all fonts are legible at menu size, screen resolution.

Some font names cannot be read when written in 12-point, screen-resolution type. Other fonts don't contain only upper-case letters; most of the name will appear as small rectangles since no lower-case letters are available. Other fonts are symbol or dingbat fonts. Such fonts don't contain letters at all so the name appears as a series of tiny pictures.

Of course, some fonts look fine in a WYSIWYG menu. In those cases, WYSIWYG menus might be useful. Overall, however, you're generally better off getting a program like theTypeBook or TypeIndexer, printing font samples of all your fonts, and then referencing the samples when it's time to choose a font. Even though some WYSIWYG menu utilities enable you to customize the appearance of each font in the menu, a printed sample is almost always a better representation of a font than an on-screen version.

WYSIWYG menus are also very slow to draw. If optimization and productivity are your goals, don't bother wasting time loading fonts every time you need to open the menu.

Font utilities do tricky things to your system. Since most font utilities sit in between the system and applications, they're prone to causing problems. Many graphics applications are written with font utilities in mind, since designers need the utilities and the applications. However, many programs don't work well with font utilities. In particular, Symantec's Suitcase and Adobe Type Reunion have been habitual problems. Even some versions of Adobe Type Manager have caused problems. If applications are having any trouble with fonts, start testing for conflicts by disabling font management utilities.

Fontographer

Fontographer is an application from Macromedia that enables you to create your own fonts or modify existing ones. You can blend typefaces, create signatures, and create logos.

Ratings

Fontographer	1	2	3	4	5
Ease of Use					
Great Features					
Coolness					
\$ Value					
Overall Rating					

Kudos and praises for Macromedia (formerly Altsys) Fontographer. My lifelong love of letters and desire to design type could only have been realized through this software, which I purchased early in the Macintosh revolution. Although not useful to everyone, this program is used worldwide by type designers (please don't use the word "fontographer" to describe someone who designs type!).

Brian Sooy
Brian Sooy & Co,
Elyria, Ohio

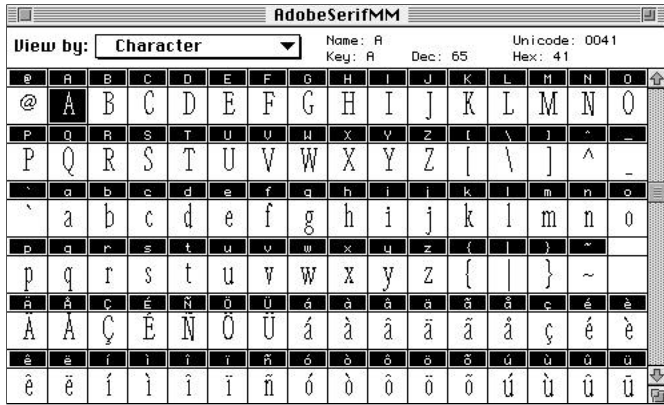

Figure 4.7
One of Fontographer's screens.

5

Life in the System Folder

Every Macintosh since January of 1984 has had a repository of mysterious files, a collection of icons with esoteric names and seemingly little function. Although the apparent disarray of files has been constantly revised and tidied by Apple, the System Folder is still one of the most confusing aspects of the Macintosh. This chapter will help you understand the System Folder and how to make it work for you.

The System Folder is aptly named. It houses the software that controls your Macintosh. Like the Wizard behind the curtain in Oz, the System is flipping the switches that make magic appear on-screen.

This chapter explains the various parts of the System Folder and helps clear up some of the confusion. By chapter's end, you will be able to manage the System Folder's tools and controls in ways that will optimize your computer's performance, improve the quality of the output, and boost your own productivity.

If you want to know...	Go to...
How can I identify an extension?	90
How can I edit my keyboard layout?	98
Which extension utility is right for me?	93
Can RAM Doubler cause conflicts?	96
How do I disable extensions?	91
How much RAM are my extensions using?	88
What if my extensions aren't causing the problem?	94
Why won't my keys type the right letters?	99
How can I organize my System Folder?	99

Extending the System

Like the Wizard of Oz, the system has a good deal of help. In the form of extensions and control panels (not Munchkins), these helpers add functionality, modify existing functions, smooth out operations, accelerate tasks, and many other useful jobs.

There are a number of different types of files that live in the System Folder. Apple Menu Items, startup items, fonts, extensions, and control panels are among them. Although the other file types are important, for now we'll focus on extensions and control panels.

Because extensions and control panels serve the same purpose, extending your system, I'll often refer to the two types of system files collectively as extensions, rather than listing them separately. Where appropriate, I will explicitly state whether something applies to extensions or control panels exclusively.

Extensions

Conveniently located in the folder labeled "Extensions," system extensions tend to be faceless. That is, there is no direct interface to an extension. Instead, most extensions invisibly enhance the system without bothering you for configuration instructions. Occasionally, however, you may find an extension that can be configured via a control panel.

Extensions are visually recognizable by their icons, which are usually shaped like a small puzzle piece. This is indicative of the way they work: extensions link together with the system to function as a single unit. Don't rely entirely on the icon as an identifier, though. A quick look in the Extensions folder will reveal a number of files without the typical puzzle-piece icon. Double-clicking the icon should display a dialog explaining that the file in question is indeed an extension.

Control Panels

Control panels are located in a folder named "Control Panels," which can be accessed from the System Folder and from the Apple menu. Unlike extensions, control panels always have some form of interface. Double-clicking a control panel or selecting it from the Apple menu opens a window in which you can access the various parameters and options that each control panel offers.

Control panels usually are identifiable by the tiny slider control drawn on the edge of their icons. Again, this is not an absolute rule, but a general guideline.

Extension Overload

The ease with which extensions and control panels can be added to the System Folder is both a boon and a burden (see Figure 5.1). Adding extensions and control panels can be accomplished by dragging the files onto the closed System Folder. The system then takes care of placing the files in the correct folders. But with installation so simple, System Folders often become bloated with too many additions. As a result, the system occupies more RAM, the machine slows down, and the potential for conflicts and other problems increases. When working with graphics, a lean system is important.



Figure 5.1
Does this look familiar? Loading too many extensions can quickly bog down the system and eat up RAM.

Ratings

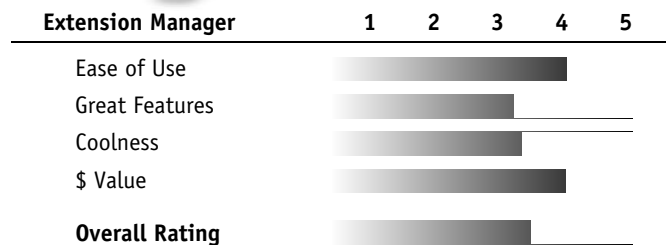

Stripping Down the System

Cleaning a system can be a heartwrenching affair. There are countless extensions and control panels that enhance the visual appeal or customize the interface of your Macintosh. Others are fun, just for laughs, or pranks to play on your co-workers. Still others provide valuable functions, but require large amounts of RAM. Determining the extensions or control panels you can live without is like trying to choose a kitten from a litter. No matter how much you want to, you can't keep all of them.

Determining Need

The first step in stripping a system of extraneous extensions is to determine which extensions and control panels serve a valuable function in the operation of your computer and which are for entertainment only. Certain extensions can't be done without. A driver for a scanner, printer, or monitor, for example, is vital. On the other hand, a control panel that enables you to customize the look of your interface by adding 3D buttons, check boxes, and radio buttons is probably not necessary. Here are a few guidelines for determining an extension's or control panel's necessity:

- Extensions that add system technologies, such as QuickTime, QuickDraw GX, and Open Transport are only used if called by an application. When using such applications, the extensions are usually required. Some applications will enable you to run without the extensions, but at the cost of some features of the application.
- Hardware drivers are necessary to access the hardware. A CD-ROM drive, for example, will require an appropriate driver. Printers, removable media drives, and input devices, such as trackballs and pen-based devices, all require some sort of driver to communicate with the system.
- Extensions and control panels that alter the look of the interface are nice, but can usually be unloaded without too much suffering. Customizing the appearance of a system is nice, but probably won't significantly enhance your productivity.
- If the name of an extension suggests it is for a different Macintosh model than your own, remove the extension. If, for example, you have a Power Macintosh 8500 and you notice PowerBook control panels in your System Folder, get rid of them.
- Control panels are often intended for a specific Macintosh and will not work on others. If you double-click a control panel and see a message explaining that the control panel will not work with your Macintosh, remove the control panel.

"Computer, tell me a joke."

In 1984, the Macintosh was unveiled and amazed the world by introducing itself. The Macintosh could speak using a technology called MacinTalk, a speech synthesizer that formed words based on sounds called phonemes.

When Apple introduced the AV line of Macs some 10 years later, the world was again amazed. This time the computer could not only speak, it could also understand speech and act upon what it heard. This technology is called PlainTalk and is now available on all Power Macintosh models, provided a PlainTalk microphone is present.

- Some extensions are installed by applications to add optional features to that program. Disable the extension or control panel if you don't use the added features. But before you do, make absolutely sure the features are optional and not required.

When you've decided which extensions and control panels you can live without, disable them by removing them from their respective folders. There are a number of utilities that can help automate the process of unloading extensions, but I'll leave that for later. We still have work to do.

Ratings

PowerTalk	1	2	3	4	5
Ease of Use	████████████████████				
Great Features	████████████████████				
Coolness	████████████████████				
\$ Value	████████████████████				
Overall Rating	████████████████████				

PlainTalk is an interesting technology. Like Star Trek, where the Captain simply says, "Computer, compose and play some soft music, calculate the current speed of all asteroids in the immediate area, and create a 19th-century murder mystery on the holodeck while I finish dictating my Captain's Log," PlainTalk enables you to issue voice commands to your computer. But unlike Star Trek, which is science fiction, PlainTalk can handle limited commands and doesn't understand everything you say to it.

For commands such as "Open Photoshop" or "What time is it," PlainTalk does fine. You can also write AppleScripts to do whatever task you like and then say the name of the script to execute it. Still, AppleScript is limited and applications that support AppleScript are even harder to find. Even when you do find a task that PlainTalk and AppleScript can handle, your speech must be very clear and articulate for PlainTalk to understand. Chances are you'll have to repeat yourself more than a few times.

The Star Trek computer also seems to have unlimited memory available since the crew never complains that they had to change the memory partitions so the voice command module could run. PlainTalk requires a large amount of RAM and chances are, you've got less RAM than the USS Enterprise computer.

All in all, PlainTalk is not a mature technology. It's certainly advanced and is a lot of fun to play with, but it has not yet reached a stage where it will help out a creative professional. With its limited capabilities, somewhat lacking comprehension, and large RAM requirements, PlainTalk will probably get in the way more than it will help. In the future, PlainTalk will mature into a useful, time-saving feature. Until then, save yourself the RAM and switch it off. (But before you turn PlainTalk off, be sure to take advantage of the best feature. Simply say "Computer, tell me a joke.")

Ratings

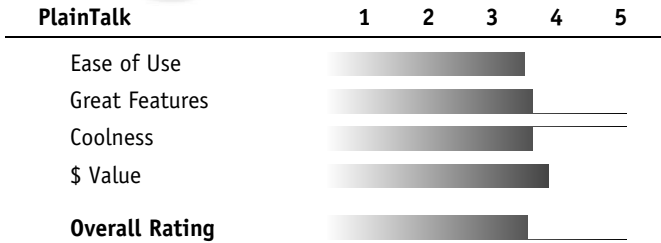

Decreasing RAM Consumption

Adding extensions to a system is a great way to customize and make the computer better suit your needs. It's also a great way to eat up all that new RAM you just installed. Systems can quickly grow from the three to four megabytes of RAM they normally require to eight, nine, or even more megabytes of RAM. With a hundred or so megabytes of RAM installed, a 10MB system isn't such an issue. But with only 32 to 64 megabytes of RAM, a 10MB system is a considerable size (see Figure 5.2).

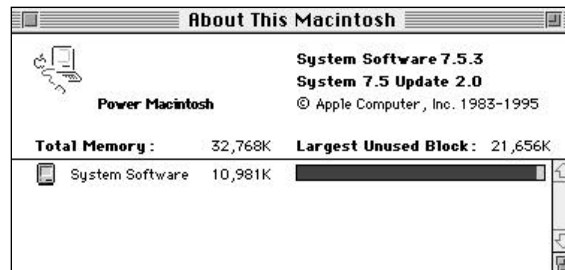

Figure 5.2
About This Macintosh reveals the excessive size of this system.

Some extensions require more memory than others. In fact, some extensions don't require any memory until used. If you pay attention to how much RAM a particular extension uses, you can better determine whether you really need it or should unload the extension when not in use.

Determining how much RAM an extension uses is not so easy without the help of an extension manager utility such as Casady and Greene's Conflict Catcher or Now Startup Manager. Both of these utilities will report exactly how much RAM each extension uses. Conflict Catcher even enables you to sort your extensions by RAM usage.

To find out the RAM consumption of an extension without the aid of an extension manager, you have to do a little detective work. Follow these steps:

- 1 Use About This Macintosh in the Apple menu to check your current RAM usage. Make note of the current RAM size of your system.
- 2 Unload a set of extensions and restart. Skip ahead to "Disabling Extensions" for more information on unloading extensions.

Ratings

Conflict Catcher	1	2	3	4	5
Ease of Use	████████████████████				
Great Features	████████████████				█
Coolness	████████████████				█
\$ Value	████████████████				█
Overall Rating	████████████████				█

- When the computer has rebooted, check the size of the system using About This Macintosh again. If the size has decreased significantly, one of the unloaded extensions is a RAM hog. Reload the extensions one at a time until the system's RAM use jumps up again. If the size of the system has not decreased, disable more extensions and try again.

After you've determined which extensions are bloating your system, you can decide whether you need the extension at all. If the extension is associated with a particular application or is only used under certain conditions, it might be better placed in an extension set to be loaded for those occasions when the extension is needed. I'll give more information on creating and using extension sets later in the chapter.

Since finding which extensions are using RAM is guesswork without additional software to help, educate your guesses. If, for example, you notice your system taking up much more RAM after installing a new piece of software, check that extension first. If you suspect a certain extension *might* use a lot of RAM, try unloading it. Consider your extensions before simply turning them off randomly.

Finally, some extensions will not use RAM until called by an application. QuickTime is a popular example. Until loaded, QuickTime will not use RAM. Once loaded, QuickTime may need a megabyte or more of RAM. QuickDraw 3D also loads only when called, using two or three megabytes of RAM at that time. Fortunately, this type of extension also unloads when finished, thus freeing the RAM it consumed.

NOTE

Sometimes an application won't properly close extensions when quitting. When this occurs, the block of RAM allocated by an extension, such as QuickTime, is not freed. No other applications can use that RAM until it is properly deallocated. There are two ways to free up lost RAM:

- A small freeware application called Mac OS Purge will attempt to reclaim any lost RAM that has accumulated. Running Mac OS Purge periodically during a work session can help maintain clear RAM.
- Restart your Mac. Every time you restart, RAM is cleared. Anything that was lost is freed automatically. If Mac OS Purge can't reclaim all your RAM, restarting will.

Identifying the Unknown

A quick look in any System Folder will probably turn up a slew of extensions and control panels whose purpose is not clear. Whether the file is useful, is using up valuable RAM, or is needed for a particular application is not apparent just by reading the name. If you find yourself with a collection of unknown extensions or control panels, try these steps to figure out what they are:

- Control panels are usually the easiest to identify. Simply double-click the control panel to open it. Take a look at the controls offered and try to identify either its purpose or the software it is associated with. Often a control panel will have a credits page or info button you can click that will tell you a little about where it came from.

NOTE

A credits page you can click to from many control panel icons contains information that could help you determine the wisdom of keeping the control panel or removing it to free up valuable RAM.

- The Finder's Get Info command helps to identify both extensions and control panels. Select the item in question and choose Get Info from the File menu (⌘-I). Read all the information in the resulting window carefully. Often you'll find the name of the company that wrote the software, or the name of the application that the extension belongs to. The Get Info window in Figure 5.3 even states explicitly what the extension does.

- If the unidentified item is an extension, check for an associated control panel.

- For the tough ones that just won't give a hint as to what they do, disable them temporarily. Put them

in a folder on your desktop and use your computer for a few days. Try each of your major applications and see if any of them complain that they're missing necessary files. Adobe's PageMaker 6.0, for example, will inform you that it cannot launch if you have disabled the Microsoft OLE extensions.



Figure 5.3

Get Info shows exactly what this extension does. Just below the file name, a description line informs us that this is a math library accelerator.

Don't throw away any extensions or control panels until you know for sure that you don't need them. It's sometimes more trouble than you might expect to get a single extension back without doing a complete reinstall of the software that extension came with. Just put them in a separate folder until you discover for certain whether you need them.

Disabling Extensions

Turning off extensions involves only the simple step of removing the files from their designated folders. Extensions are removed from the Extensions folder and control panels are removed from the Control Panels folder. You can do this manually, or you can use any of a number of applications that do it for you.

Most extension-disabling utilities use a similar organization of disabled extensions. A set of folders is created within the System Folder, each with the name of the file type it contains and the suffix "(disabled)." Disabled control panels, for example, are stored in a folder called "Control Panels (disabled)." If you choose to turn off extensions manually, using the same organization makes sense and makes switching to one of the extension managing utilities easier later.

There are three major utilities for managing extensions and control panels:

- Extensions Manager** is the simplest of the three and is included with System 7.5 and later. For your most basic extension disabling needs, Extensions Manager does quite well. You can save sets of extensions and select the sets on startup by pressing the Spacebar.

<http://www.apple.com/>

A/ROSE is A/ROSE is A/ROSE

Some of the hardest extensions to identify are written by Apple and installed with the system. You might think that means they're necessary, but in fact, many of them are not. A few of the more common mystery extensions are listed here. For a more complete listing, check out the Power Mac Pruning Page at:

<http://www.AmbrosiaSW.com/DEF/>

or the Macintosh Extensions Guide at:

<http://www.terracom.net/~jhaas/ext/>

A/ROSE stands for Apple Real-time Operating System Environment and is used for a select few Nubus networking cards. Only four of Apple's own cards use A/ROSE: Apple Coax/TwinAx NB, Apple Ethernet NB, Apple Serial NB, and Apple Token Ring Card. Built-in Ethernet cards do not use A/ROSE, and third-party cards will specify in their documentation whether A/ROSE is needed. If you don't have any of these network cards (or if your machine isn't on a network at all), disable A/ROSE.

continues

continued

Clipping Extension is part of Apple's Drag and Drop technology. The extension enables you to drag text and images to the desktop to create a "clipping" file. If this extension is disabled, drag-and-drop will still work within and between applications.

CloseView is a control panel that magnifies a section of the screen. It is intended to help people who have trouble reading the screen and is not necessary otherwise.

Color Picker provides an extensible color picker. Any application that calls the standard Apple color picker will get the picker that this extension provides. If disabled, the color picker reverts to the pre-System 7.5 color picker.

Easy Access helps people with disabilities who might have trouble with the mouse or keyboard. You can turn it off if you don't need its features.

EM Extension belongs to Apple's Extensions Manager. If you use the Extensions Manager, you need the EM Extension. If you use a third-party management utility, disable the EM Extension.

Apple Multimedia Tuner is an extension to patch other extensions: QuickTime and Sound Manager 3.0. It provides bug fixes and enhancements to both extensions. QuickTime 2.1 and Sound Manager 3.1, however, no longer require the Tuner, and you can throw it away if your extensions are up-to-date.

Password Security only works on PowerBooks. If you don't have a PowerBook, or if you don't need password protection, disable the control panel.

QuickTime Musical Instruments are a set of MIDI instruments for playing back MIDI music files. Some games and music software use the musical instruments and some QuickTime movies have MIDI soundtracks built in. For most graphics work, you won't need them.

QuickTime PowerPlug makes QuickTime run natively on Power Macintosh machines. If you have a Power Mac, the PowerPlug is an absolute necessity for using QuickTime. If you have an older, 68K-based Mac, toss the PowerPlug.

Token Ring is necessary if you're on a token ring network. If not, get rid of it.

- Now Startup Manager** is part of the Now Utilities package. Startup Manager provides a number of features that Extensions Manager doesn't have. Startup Manager, for instance, enables and disables fonts and startup items, in addition to extensions and control panels. Also, Startup Manager does automated conflict resolution, which I'll talk about later in this chapter.

<http://www.nowsoft.com/>

- Conflict Catcher**, by Casady and Greene is the most powerful of the three. Conflict Catcher enables and disables even Apple Menu Items along with all the other file types. Advanced conflict resolution, automatic startup sets based on system conditions, and the capability to identify nonnative extensions slowing down your Power Mac are only a small part of Conflict Catcher's capabilities.

<http://www.casadyg.com/>

Now Utilities Mighty, mighty, mighty. NowMenus and Super Boomerang alone—EACH alone—is worth the price. Startup Manager ain't bad at what it does, either.

The Right Tool for the Job

Conflict Catcher is my tool of choice for startup managers, despite Extension Manager being free with the System. Here's why:

Conflict Catcher is a complex tool with a single purpose: to manage your system. The other utilities are small parts of far more complex packages. Because the competing products have more to focus on than just managing your system, they are not as refined toward that single task.

Multipurpose tools are convenient because one purchase covers a number of bases. Many software packages are moving in that direction (word processors, most notably). Still, despite the opinion of some software companies, those packages that specialize are almost invariably better than packages that attempt to provide complete solutions to many problems.

Thus, Conflict Catcher, being a specialized tool with a single purpose, is better suited to the task than the other tools.

Isolating Extension Conflicts

When applications begin to crash a little too often, won't launch, or otherwise are behaving oddly, many people assume they have contracted one of those deadly computer viruses they keep hearing about in the news. When the virus scanning software turns up nothing, it is assumed that this is a new virus that has just hit the streets. The truth is it's probably nothing more than a conflict between two or more extensions.

Now Utilities. It's cool, but it causes me grief, too. With all those extensions, the system size really grows, and the potential for conflict grows as well.

Extension conflicts are inevitable on the Mac. Sooner or later, an extension is installed that interferes with the operation of another extension or an application. When an extension conflict occurs, the difficulty lies in determining which extension is the culprit.

Before you begin trying to track down a specific extension, you should make sure that an extension is indeed causing the problem. To do so, simply restart your machine and hold down the Shift key. Hold the Shift key until the "Welcome to Macintosh" screen appears. The window should say "Welcome to Macintosh. Extensions Disabled." The system then boots

Cleaner Systems Via Extension Sets

All three of the extension managing tools discussed here have some method to group extensions into sets. Whichever tool you choose, make good use of extension sets.

A set of extensions is a particular configuration of enabled and disabled extensions. The purpose of forming extension sets is to load only those extensions needed for a particular task. Unnecessary extensions are not loaded, so RAM and system resources are not wasted. For example, a set might be created for working with Photoshop including QuickTime, scanner drivers, and color calibration software. Another set, for use with Adobe Premiere would include QuickTime and drivers for a video capture board. A third set would be created for getting online and would load networking software.

The only downside to extension sets is that switching sets means restarting the machine. Restarting should be faster, though, because a limited number of extensions will be loaded.

without loading any extensions at all. Test to see if the problems still occur. If an application was crashing, run it for a while, use it, and see if it crashes. If odd behavior was tied to a specific action, try that action. Look for whatever peculiar behavior you had observed. If the behavior does *not* occur, then the culprit most likely *is* an extension conflict, because the offending extension is not loaded. If the behavior *does* occur, the problem may be more serious since unloading extensions did not affect it.

If starting with extensions off reveals an extension conflict as the problem, there are a few approaches you can take to solve the problem.

Research is the best place to start. A lot of people use Macs and some may already have encountered the problem you're having. A utility from Teknosys called Help! scans your system configuration and compares it with a large database of known conflicts. When a conflict is found, Help! will report the problems for you to fix.

A large and constantly updated database is kept online at the Complete Conflict Compendium (C3):

<http://www.islandnet.com/~quill/c3data.html>

Check in and search the database for problems similar to your own. There's even an area to post questions about potential conflicts you haven't resolved.

If research turns up no information, you'll have to track down the conflict on your own. Conflict searches can be done manually, or with the help of a conflict resolution utility.

Resolving Conflicts Manually

To test for conflicts manually, you must perform what's called a "binary search." Binary searches are simple yes or no tests. Does the conflict still exist under these conditions? If yes, perform action A. If no, perform action B. More specifically, here's how to perform a binary search:

- 1 Disable half of your extension set. A good division to start with is control panels and extensions. Disable all your extensions, but leave all your control panels active.
- 2 Restart the machine.
- 3 Determine if the problem still exists. Try the software that exhibited the errors before.
- 4 If the problem *does* exist, go to step one and repeat with the current extension set. That is, cut in half the extensions you have loaded now.
- 5 If the problem *does not* exist, go to step one and repeat with the other half of the extensions, the half disabled previously.

When Extensions Aren't The Problem

Sometimes problems arise that won't go away when extensions are disabled. Such cases are usually more serious than an extension conflict, but can often be solved easily.

- If a particular application is having problems, the error could be with that application. Look in the System Folder's Preferences folder for a preferences file

- 6 Repeat steps 1 to 5 until you have a single extension left.
- 7 Startup with only the last extension active.
- 8 Determine if the problem still exists.
- 9 If the problem *does* exist, you've most likely found the culprit. Disable this extension and restart with your other extensions active.
- 10 If the problem *does not* exist, the cause is most likely more than one extension. You can test for such a case by repeating the binary search while keeping this last extension active for all tests.

TIP

You can save yourself considerable time tracking down extension conflicts with a little thought beforehand. Before performing a binary search, consider recent additions to your System Folder. Did the problem appear shortly after installing a new version of the print driver? Try disabling the print driver first. Perhaps you decided to try out a new extension to make your scroll bars look like something out of Star Trek and now applications are having trouble displaying windows. Whatever the problem, think about how your system had changed before the conflict began and use that as a starting point. You might get to the root of the problem very quickly.

Automating Conflict Resolution

Automated conflict resolution programs use binary searching as well. Such programs just do a good job of hiding the tedious parts from the user. Now Software's Now Startup Manager and Casady and Greene's Conflict Catcher both provide conflict resolution capabilities. As with the manual binary search, each performs a series of tests, asking you to verify whether the problem occurs during each trial. When the tests are finished, each utility reports whether it found a particular extension that was causing the problem, or whether it thinks there are two or more extensions involved in the conflict that require further testing.

associated with the application in question. If you find one, it's possible that the file is corrupted and should be thrown away. Most applications will generate a new, uncorrupted preferences file if the old one is missing. Alternatively, if throwing out the preferences doesn't work, the application itself may be corrupted. Reinstall from the original disks and try again.

- Problems relating to hard, floppy, or removable disks, saving or opening files, or with odd file behavior in the Finder may be caused by errors on the disk. Run Norton Utilities, MacTools, or Disk First Aid to find problems if they exist. All three applications should fix the errors if possible.
- You *might* have a virus. Although Mac viruses are fairly rare, it's still possible to get them. A quick scan with virus software, such as John Norstad's freeware Disinfectant, will confirm whether you do have a virus. See Chapter 6 for more information on viruses.
- System-wide errors may be caused by corruption in the Parameter RAM, or PRAM. PRAM is a small part of RAM where the system stores user-specified preferences and other system information. Occasionally, data stored in PRAM becomes corrupted and the PRAM must be reset. You can "zap the PRAM" by restarting your Mac while holding ⌘-Option-P-R. Hold the keys until you hear a second system chime and then release. You can

continues

continued

perform the same function via a freeware tool from MicroMat Computer Systems called TechTool™. TechTool actually does a better job of zapping PRAM than the system does on its own. Either way you zap it, you'll have to open a few control panels afterward to reset all your preferences that were erased.

- Widespread problems may also be caused by corruption in the Finder Preferences file. Trash it and restart. The Finder will create a new preferences file and, hopefully, the problems will be solved.
- The System File itself may be damaged. TechTool can verify some systems and is a good place to start. If TechTool reports a problem, reinstall the system from disk. If TechTool cannot check your system version, it's probably a good idea to reinstall the system anyway. Apple's installers make it easy to do and it'll save you the headache you'd get if the system does start causing problems.

Both utilities, however, also add searching capabilities that would be quite tedious to do by hand. Some extension conflicts, for example, can be resolved simply by reordering the way the extensions load at startup. Startup Manager and Conflict Catcher both can reorder extension loading for you. Conflict Catcher is my weapon of choice, because it goes even further to keep track of recently added extensions and enables me to use intuition to start testing with a particular extension or control panel. The time saved by these features is substantial.

Hidden System Files—The System as a Suitcase

If you ever used a Macintosh before System 7, you might remember an arcane utility called the Font/DA Mover. Font/DA Mover was required to install or remove system files. At that time, files kept in the system were fonts, sounds, and DAs, or Desk Accessories, now called Apple Menu Items. System 7 made a major advance in system management by replacing the old system with a system suitcase.

Like a font suitcase, the system suitcase functions much like a folder, but is a different sort of container. There are limitations on what files can be placed in a suitcase and how many. The system suitcase even has special

RAM Doubler

Some extensions are particularly prone to conflict. Extensions that replace or modify system functions, or otherwise get in between applications and the system, are likely suspects for conflict. For example, RAM Doubler from Connectix sits between applications and RAM. When data is passed to RAM from an application, the data is compressed. When the data is passed back to the application from RAM, RAM Doubler decompresses the data. The end result is an apparent doubling of your RAM capacity. But for applications that use RAM intensively, as most graphics packages do, RAM Doubler can interfere. Extensions that modify the way interface elements draw are another example of software prone to conflict. Such programs intercept calls to the system to draw windows, scroll bars, and the like. Usually applications don't care what the window looks like as long as it functions correctly. Sometimes an application will have itself modified a call to draw interface elements. When the two modifications collide, conflicts can occur.

limitations not shared by font suitcases, such as the requirement that all applications quit before changes can be made.

In System 7.0, the system suitcase contained three file types: fonts, sounds, and keyboards. Desk Accessories were moved to the new Apple Menu Items folder. The file type introduced, keyboards, which are different keyboard layouts enabling the user to switch between layouts for different languages or key preferences, such as the Dvorak layout.

System 7.1 introduced one more system change, which brings us to the current state of the System Folder: the fonts moved to their own folder, enabling fonts to be added or removed without quitting applications.

Still remaining in the System 7.1 system file, and also in current system files, are sounds and keyboard layouts. The system comes with a host of each file type installed and more can be added by dragging onto the closed System Folder, or the system file itself. However, too many sounds can bloat your system, and too many keyboards can get in the way.

The Size of a System Sound

Sounds, like video and graphics, can take up large amounts of disk space if not compressed. That's why only 74 minutes of audio fits on a standard compact disc. It takes 650MB to store that amount of data. Likewise, system sounds can add up in size quickly. Usually system sounds are stored at lower quality than CD sound, so the file size is considerably smaller. Still, drop a few extra sounds in the System Folder and they'll quickly add up (see Figure 5.4).

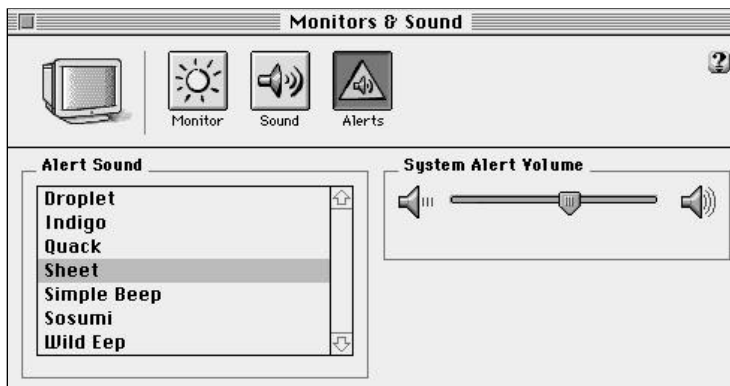

TIP

Duplicate versions of the same software can cause conflicts with each other, particularly if different versions are installed at the same time. QuickTime is often the victim of duplicate installed extension conflicts, because many applications install and use QuickTime. An older application might install an older QuickTime even if there is a newer version installed. When an application calls QuickTime, the two extensions can cause problems. If you notice duplicates of any extension, check which version is newer via Get Info (⌘-I) and unload the older one.

Figure 5.4

Sounds appear in the Sound control panel, or in the alerts section of Monitors & Sound.

The most important consideration when selecting sounds for the system and specifically for the system beep, is the size when loaded into RAM. Every time the Mac beeps, the beep sound must be loaded into RAM,

played, and unloaded. You don't want a 300KB, CD-quality sound to load when your favorite image editing package beeps to tell you it's low on RAM. Generally, a simple, quick sound suffices for a beep and won't get in the way when you need all the RAM you can get.

If you find or create a sound that you absolutely must use for your system beep, use a sound editing utility, such as Macromedia's Sound Edit 16, to reduce the sound quality or add compression.

Choosing a Keyboard Layout

System 7.5 comes with a host of keyboard layouts for different system versions and different languages around the world. Depending on the system and language you're using, you can select an appropriate keyboard layout to map keys on your keyboard to the proper characters on-screen. You can add more keyboard layouts as desired and some applications even come with their own layouts to remap keys for other specific purposes. Such applications load the keyboards as needed. For system-wide keyboard layouts, you can specify the keyboard via the Keyboard control panel.

Opening the Keyboard control panel should reveal quite a number of different layouts. Determining which you need and which you don't need is straightforward. If you use a particular layout, keep it. If not, trash it. Most likely, you won't need more than two or three, if that (see Figure 5.5). In fact, the standard System 7 keyboard layout is built in. So, if you don't use any other layout, and you don't have applications that use keyboard layouts (communications software, such as NCSA Telnet, is typically the only type of application that uses keyboard layouts with any frequency), you can trash all of them without disturbing the standard layout.

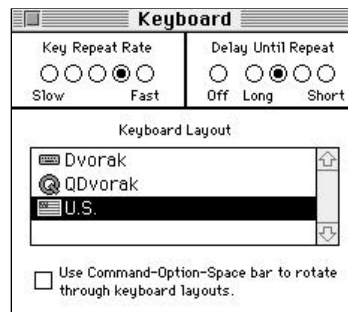

Figure 5.5
With extra keyboards removed, the Keyboard control panel is easier to navigate.

Scrambled Keys

Photoshop popularized the ⌘ -spacebar convention for bringing up a Zoom tool. Since the Option key is typically used to reverse the effects of a tool, ⌘ -Option-spacebar is used to zoom out with the magnifier instead of zooming in. You may have noticed, however, that keys start behaving oddly after using ⌘ -Option-spacebar to zoom out on an image. That's because ⌘ -Option-spacebar is also the system's command to cycle keyboard layouts. So, when you zoomed out on your image, you also asked the system to remap your keys to different characters. Fortunately, you can disable the keyboard cycling command. Simply open the Keyboard control panel and uncheck the box labeled "Use ⌘ -Option-spacebar to rotate through keyboard layouts." Now your Photoshop tools should all behave correctly.

Uncovering the Hidden Keyboard Menu

If you do have reason to use different keyboard layouts, the system has a hidden feature to enable fast keyboard switching that won't interfere with other programs. There is a menu built into the system that displays installed keyboard layouts and enables you to choose between them (see Figure 5.6).



Figure 5.6
The Keyboard menu makes switching keyboards simple.

Revealing the menu takes a little technical skill and a program from Apple called ResEdit. If you're not familiar with ResEdit, I don't recommend trying this; or if you do try it, be sure to

work with a *duplicate* of the System File. If you change the wrong settings, you might have trouble changing them back.

To display the Keyboard menu, follow these steps:

- 1 Duplicate your System File using the Finder's Duplicate command (⌘-D).
- 2 Launch ResEdit and open the System File.
- 3 Locate the resource labeled "itlc" and double-click to open it.
- 4 Scroll down the window until you find the radio buttons labeled "Always show kybd. icon."
- 5 Click the 1 button.
- 6 Save, quit, and restart your Mac.

If everything went well, an icon will appear in the menu bar in between the AppleGuide menu and the Applications menu. The menu will display a list of installed keyboard layouts, and the menu icon represents the currently selected layout.

Organizing System Files

After stripping down extensions, removing outdated or duplicate files, and eliminating any conflicts that may have occurred, you'll probably want to find a way to organize your System Folder so that the next visit isn't such a hassle.

The hierarchy of the System Folder is basically set in stone. If you make changes to the folders the system needs, chances are you'll run into trouble. The system looks for folders by name and changing folder names or introducing other folders into the hierarchy will just confuse the system.

Organizational changes to the System Folder need to be done at a cosmetic, rather than structural level. The system provides a very effective means to do this.

The Labels menu is an often-overlooked, yet useful feature of the Finder. Select any file or group of files, choose a label from the Labels menu, and the Finder assigns that label to the selected files. Labels enable you to sort the files into groups you specify, rather than only by the built-in sorting groups, such as file type and modification date.

Labels are customizable from the Labels control panel (see Figure 5.7). You can change colors and rename the individual labels. I don't pay much attention to the actual name of the label, though. Instead, I use the Finder's List by Label option to sort my System Folder. By grouping enabled extension folders with one label, disabled extensions folders with another label, system files with a third label, and miscellaneous other items with a fourth, I force the System Folder to display items in a specific order. The most used folders are at the top of the window each time I open it. Scrolling through long lists of files to find the Control Panels or Extensions folder is not necessary, because both folders now reside at the top of the list (see Figure 5.8).



Figure 5.7

Label color and name can be configured via the Labels control panel.

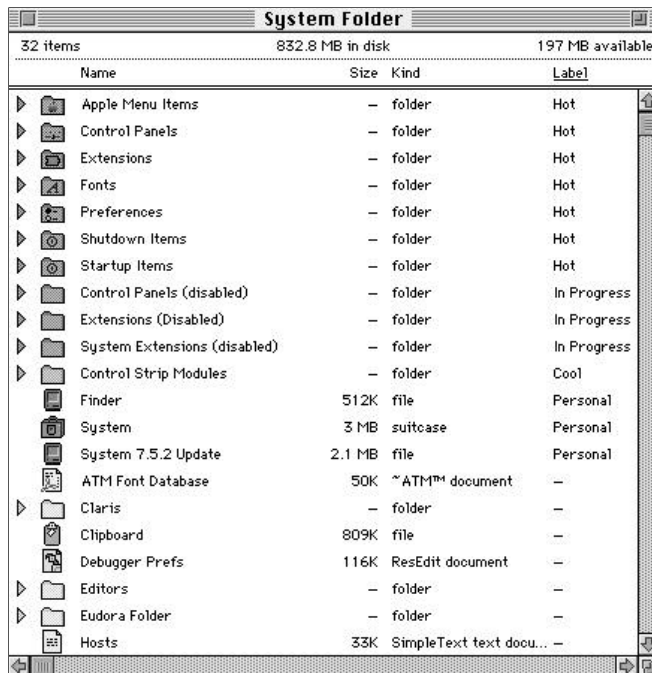

Figure 5.8

Navigating the System Folder is easy after the files and folders have been organized by label.

NOTE

For those folders that you access most often, creating an alias can simplify file management. For example, if you find yourself frequently digging into the System Folder to access the Apple Menu Items, create an alias by selecting the Apple Menu Items folder and choosing "Make Alias" (⌘-M) from the File menu. Store the alias on the desktop or somewhere on your hard disk. You can even stash the alias in the Apple Menu Items folder so that the folder can be opened directly from the Apple menu.

To organize your System Folder in this manner, follow these steps:

- 1** Select the folders and files you want to group. I selected all the system's folders, such as Extensions, Control Panels, Apple Menu Items, Startup Items, and the like.
- 2** Select a label from the Labels menu. You can select any label, but the order of priority is from the top of the menu down to the bottom. Label sorting occurs in the same order in a window.
- 3** Select By Label from the View menu. If By Label does not appear in the menu, open the Views control panel and check Show Label.

There is that magic moment on a Macintosh when the computer disappears, the interface disappears, and it's just the artist and the piece, in total harmony and control. Only the Mac OS is so utterly transparent. Even after 10 years, I am still struck by the elegance of it. As we say, ———
Screaming in Digital!
—————

Matt Federoff
Adobe Certified Photoshop
Instructor
Tucson, AZ

6

Optimizing Your Mac

No matter how fast a machine is, or how impressive the speed seems, after a few months of usage, the thrill of speed fades. As work habits adapt to new capabilities opened by having more processing power, the extra speed gained in a new machine is exploited, leaving a feeling that the machine is not so fast after all.

Such is the case with any new machine; it was even true when the Power Macintosh was first released, and Mac users scoffed at the relative sluggishness of the older 680×0-based Macs. After a few months adjustment to the speed of Power Macintosh, users clamored for more speed. Even an 8100/80 wasn't fast enough for creative professionals, who typically demand the most power of their machines.

Two years later, the same users who scoffed at 68k machines were snickering at the slow pace of the 60 MHz Power Macintosh 6100/60. The new PowerPC 604-based Power Macs eclipsed the older machines in speed and power. But, as usual, it wasn't long before users began to demand more of

If you want to know...

Go to...

Why is my hard disk running slow?	108
I'm running out of memory. What should I do?	115
What are QuickKeys?	126
What is the difference in RAM speeds?	112
Are my custom icons slowing my machine?	106
What is interleaving?	114
Should I buy an accelerator?	117
What is AppleScript?	126
How can I better organize my applications?	130
Do I have a virus?	123

their machines than the processors could handle efficiently. Once again, the speed boost wears off as users find more and better ways to absorb the difference.

So what can a creative professional do to keep up with the times? It's probably not economically feasible to buy a new machine each time one is available. Instead, there are methods to extend an existing machine by adding acceleration tools and hardware, optimizing work styles, and by taking care to keep hardware and software clean.

Hardware Optimization

The best place to begin optimizations is with hardware. Although optimizing hardware tends to cost more, the benefits are greater. Especially in the graphics field, increasing raw computing power is the most effective way to improve performance.

Graphics and multimedia work consists of two main tasks: processing data and moving it. The first task, processing data, is what happens when images are altered in Adobe Photoshop, or QuickTime movies are combined in Adobe Premiere. The computer's processor must churn through every pixel of every image or frame and calculate new, combined pixels. No software can speed that up like a faster processor or an accelerator.

The other half of the process, moving data, is getting the images or frames from disk, storing them in RAM, passing information back and forth to the processor, and eventually storing the data back on disk. A number of data pathways inside the computer are responsible, and speeding up any of them can help accelerate your work.

Because of the costs associated with each method of acceleration, I'll present them in the order I recommend you perform them. The first methods presented are regular maintenance that will keep disks operating at top performance. From there, we'll move into more expensive add-ons that accelerate the operation of your Macintosh.

Disk Performance

Over time and through regular usage, the performance of a hard drive or removable media disk will decline. Depending on conditions, the degradation in performance can range from barely noticeable to barely usable. Regular maintenance can help maintain the original performance of the disk and maintain the integrity of files.

Cleaning Up

Only a few years ago, a 100MB drive was of adequate size. All your applications fit with room to spare for scratch disk space. Now swap out the 100MB drive for a 500MB drive. It seems large at first, but soon applications and files fill the space. You might wonder how 100 megabytes was ever acceptable. Install a gigabyte drive and again, the space fills.

The trick to maintaining a hard drive with space to spare for applications' scratch files is not to use it as a storage device. That's what removable media is for. Application size continues to grow, but at a much slower rate than file size. A 2 gigabyte drive fills quickly when loaded with movie data. When the project is finished, compress the files and drop them on an Iomega Jaz disk. With a gigabyte per disk, Jaz is certainly an economical way to store files.

Trick number two is not to be a packrat. Suppose you just downloaded a cool new shareware image processor. Do you need it? If you think you *might* need it in the future, compress the application and put it on disk. There's no sense in keeping it on your hard drive for some arbitrary period of time until you need it. Keep the staple applications, such as Adobe Photoshop or Fractal Design Painter. Keep the applications you use. I can't tell you how many hard drives I've seen stuffed to the gills with software waiting to be used, but gathering virtual dust. Let Photoshop use the space instead.

Even if you diligently delete every application you don't need and move all old files to archives on a Jaz disk, hard drives tend to get cluttered over time. Applications are added and deleted, leaving preferences behind. Aliases become detached from their applications, and invisible files are installed. Eventually, the buildup of leftover files grows to significant size. Preferences files, for example, are typically small. But when 30 or 40 preferences files are left by deleted applications, the cumulative space used is not so small.

The solution is to open the Preferences folder and scan through for files belonging to applications you don't have. If an alias is broken, remove it or replace it. Two applications, File Buddy, by Laurence Harris, and ZiffNet/Mac's Clean Sweep, can automate the process for you. Both applications scan for unnecessary files and report their findings. If a preferences file has no application, either application will tell you, offering the option of deleting the offending file. File Buddy is a bit more powerful than Clean Sweep, and I recommend using it religiously. A regular scan with File Buddy can turn up hundreds of kilobytes worth of wasted disk space. Keep the drive clean and the applications you do use will be happy to have extra space.

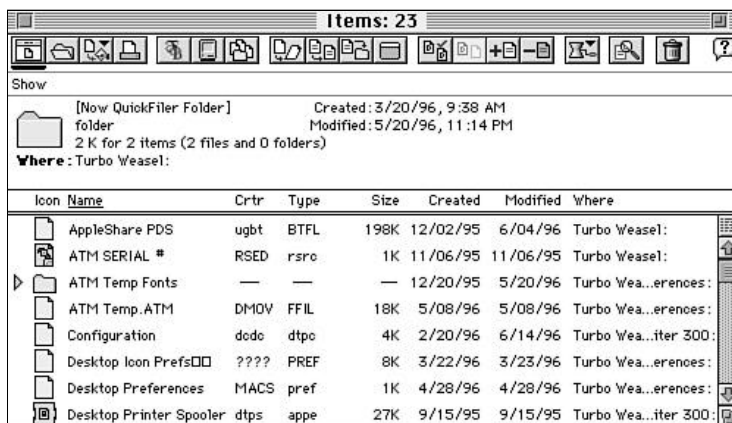

Figure 6.1
Among File Buddy's many functions, Find Invisible enables you to see hidden files.

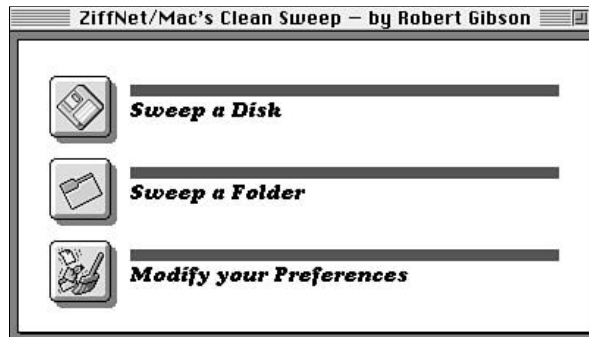

Figure 6.2

Clean Sweep's simpler interface isn't as powerful as File Buddy's.

Before running File Buddy or Clean Sweep, rebuild the desktop. To do so, restart your Mac and hold the \mathcal{H} and Option keys down. Click OK when asked whether you want to rebuild the desktop. To do so helps to ensure that you won't accidentally delete files that have become disconnected from the application that created them. It's not foolproof, though, so be careful what you tell File Buddy to delete. Preferences sometimes store important information that cannot be easily recovered.

Rebuilding the Desktop

NOTE

Have you ever saved a file and noticed that it didn't appear as a file on disk for a few minutes? Or noticed that a file was missing, yet magically reappeared when you use the Find command to locate it? That's because the Desktop file has not been updated yet. The Macintosh is not yet aware that the file exists, so it isn't drawn. As soon as the Desktop file is updated, or forced to update by using Find, the file appears.

The Desktop file is an invisible database stored on every Macintosh disk. The database contains information on every file, folder, and application contained in that disk. Included in the Desktop file are icons, file types and creators, and location of files. When files are added to a disk, they are also added to the Desktop file on that disk.

In theory, when a file or application is deleted, its record in the Desktop file should also be deleted. In reality, though, that's not always the case. In fact, files are not always *added* to the Desktop file either. And sometimes, files that were in the Desktop file get lost. (That's why files sometimes mysteriously turn up with a blank icon and can't be launched when double-clicked. "The application can't be found," complains the Mac.)

The solution to corrupted Desktop files is simply to rebuild the database. The Mac OS has a built-in method to force a desktop rebuild. To do so, restart the Macintosh. Press and hold the \mathcal{H} +Option keys. When presented with a dialog asking permission to rebuild the desktop, click OK. The Finder then erases and rebuilds the Desktop file, hopefully clearing up any problems the old Desktop file contained.

Custom Icons, Custom Interfaces

The capability to customize an icon as easily as cut and paste is a feature unique to Macintosh. It's also a drawback of Macintosh.

As cool as customizing every icon on your hard drive may look, it also slows down operations in the Finder, particularly with file sharing. For every file or folder the Finder has to draw, there are two choices. First, the Finder can draw a default file or folder icon. That's easy; the Finder knows what the icon looks like and draws it quickly. If

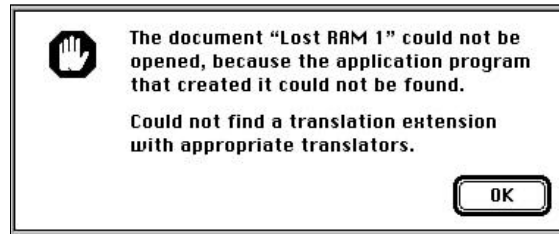
**Figure 6.4**

When Desktop files become corrupted, the system may not be able to find applications.

Although the Finder's desktop rebuild is adequate, it's not always good enough. When the Finder rebuilds a Desktop file, a small part of the original database is retained. If corruption exists in that part of the database, rebuilding the desktop via the Finder will not solve the problem. Fortunately, TechTool has a solution. TechTool is a free utility that does a better job at rebuilding the desktop than the Finder. How? TechTool actually erases the entire Desktop file and then allows the Finder to build a new one completely from scratch. For the cleanest Desktop file possible, use TechTool. It's free and performs a number of other functions as well.

Optimizing Existing Disks

Believe it or not, normal disk usage will eventually slow down a disk, no matter how careful you are to delete unnecessary files and rebuild the desktop. What causes this problem and how can it be avoided? Well, it can't be avoided. In fact, graphics applications tend to accelerate the

a file or folder contains a custom icon, the Finder must look up the icon, read it from disk, and draw it to the screen. It's easy ...if only a few files have custom icons. Screen redraw slows considerably if the Finder has to look up every icon before drawing it.

**Figure 6.3**

Custom icons like these are nice to look at but slow down Finder operations.

The most noticeable slow down comes when disk access speed is reduced. If you've ever seen a CD-ROM with custom file icons on every file or folder, you may have noticed how slowly windows draw. Opening windows from a computer across a network is slow as well. If the remote machine has a lot of custom icons, each one must be sent individually to the local computer, instead of using the default icons that are already in RAM.

Having a number of custom icons also increases the size of your Desktop file. The Desktop

continues

continued

file is a database of all your applications and files, containing both icons and file type/creator information. The bigger the Desktop file becomes, the more the Finder has to search through when trying to look up icons or type and creator information.

There are, however, some valuable uses of custom icons. Many graphics applications, for example, can now save a tiny preview graphic as the icon. The preview is made from the file represented by the icon, and is very useful for identifying files quickly. Also, if an application doesn't create file-specific icons, it probably will create icons indicating that the file was created with that particular application. In that case, redraw speed is not reduced noticeably, because one icon image is used on multiple files. In these cases, using custom icons is useful. By confining custom icon usage to specific purposes like these, you can at least slow the growth of your Desktop file and keep speed up.

problem. I'll tell you how in a moment. First, here's what slows down the disk: file fragmentation. When files are written to a clean disk, they are stored at the end of the data already on disk, as you would expect. But when files are deleted, holes are opened in the previously contiguous data blocks. When a new file is written to disk, it may be written into the space left by the deleted file. If the new file doesn't quite fit in the old space, the file will be broken and stored in two or more places on disk. That's fragmentation and that's what slows the disk. To access the file, the hard drive heads must jump around the disk locating and reading all the file parts, rather than simply reading straight through the file. As more and more files become fragmented, the hard drive performance drops.

Norton Utilities... would die without it.

Now, how do graphics applications contribute to the fragmentation problem? Because of the RAM required to do image processing, many programs implement their own forms of virtual memory, often called scratch space. Basically, when extra memory is needed, the application stores information in a temporary invisible file on disk. When the memory is no longer needed, or when you quit the application, the temporary file is erased. Thus, through normal usage of a graphics program, you may be creating and deleting many files. Each time a file is deleted and a new one created, the probability of getting fragmentation increases.

I love Norton, but who knows if all the problems it claims to fix are real or not. Most of the disk errors are so mysterious.

Fragmentation is not something to worry about, though. It's a natural result of the system trying not to waste space on a hard drive. To regain the performance lost to fragmentation, simply optimize, or defragment the drive. Symantec makes an excellent utility for just that. Part of the Norton Utilities, Speed Disk examines files on a disk and rearranges them for optimal speed (see Figure 6.5). Files are rejoined if fragmented, and files are placed in order with all blank space at the end. When Speed Disk is finished, your drive will look like you've never erased a thing from it. I

recommend running Speed Disk regularly, about every month or two, depending on how much you use your hard drives.

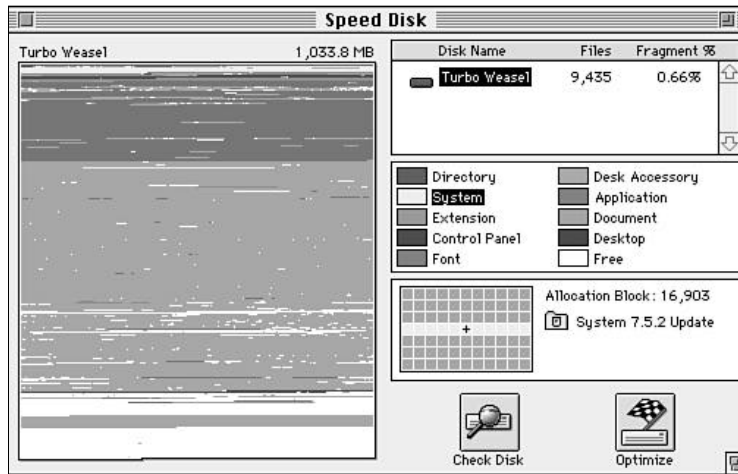

Figure 6.5
Norton Speed Disk speeds up disks by tidying up the data.

Ratings

Norton Utilities	1	2	3	4	5
Ease of Use	████████████████				
Great Features	████████████████			██████████	
Coolness	████████████████				██████████
\$ Value	████████████████			██████████	
Overall Rating	████████████████				██████████

Hard Drive Limitations

Despite your best efforts to keep a drive clean, there's still a physical limit to how fast data can be written and read. All drives have a peak operational speed. When you're operating at that limit, data can't be moved any faster; this is a speed limit that really can't be broken. The only solution at this point is to get a faster drive. Fortunately, there are a number of options, ranging from cheap to expensive and offering speed increases consistent with the price paid.

On the low end, you can purchase a hard drive with a faster access time. Every drive should have an access time listed, usually measured in milliseconds. The fewer milliseconds it takes to find data, the faster the drive is. While the difference between the access time of a CD-ROM and a hard drive is significant, when discussing a difference of one or two milliseconds, the speed increase is negligible. Get the fastest you can, but don't be picky. A nine millisecond access time is not going to add up to a lot compared to a ten millisecond access time.

Disk Arrays

When fast access time is imperative, consider a disk array. In a disk array, multiple disks are used together as a single disk. By alternating which disk is being used to read or write, data can be accessed much faster.

Some disk arrays are too fast to be plugged into a standard SCSI bus. Such systems require a SCSI-2 or faster bus to move data at an accelerated rate. SCSI-2 is a faster bus than Apple's standard SCSI and can accommodate the higher data rate required by fast hard drives. FWB's Sledgehammer disk arrays, for example, often come with a card that gives your Mac SCSI-2 capabilities.

If possible, use a disk array. When moving data quickly is critical, such as with full-motion, full-screen video, only a disk array can provide the speed needed to retrieve the data in real time. If the drive isn't fast enough, video playback will pause temporarily while the next frames are read from disk. When fast reading or smooth playback of large files is necessary, only a disk array will do.

RAM Performance

The computer's memory, RAM, is where data that's being used is stored. When an application is launched, the application allocates a block of RAM for itself, plus extra RAM to store open documents in. Each document opened, whether a still image, movie clip, or multimedia presentation, takes a piece of the extra RAM. Whatever part of the allocated RAM that's leftover gets used on a temporary basis for data processing.

If an application doesn't have enough RAM to work with, two things can happen. First, the application might have its own form of virtual memory. In that case, some information will be stored on disk, rather than in RAM. The problem is that no disk can compare with the speed of RAM. Thus, when information must be written to and read from disk instead of RAM, you'll see a significant performance hit. Although still usable and certainly not as slow as the system's virtual memory, using disk-based memory is always notably slower than real RAM.

The second possible result of not having enough RAM allocated to an application is that operations can fail. Applications can store data on disk that's not immediately needed. But for actual data processing, the information must be in the computer's memory. Thus, if the allocated RAM is not enough to allow data processing to occur, even when all other data has been safely stored on disk, the application will report that it doesn't have enough memory to continue.

An application should always inform you when it has run out of memory. But the capability to do so is dependent entirely on the application. If a particular application does not have adequate memory checking routines, the program may crash instead. If you've ever seen a dialog that says, "The application X has quit unexpectedly because of a system error #25," that's an out of memory error. The only way to find out how well an application

behaves is by trial and error. So save your work often in low-memory situations, especially before you perform an operation that requires a lot of RAM.

When applications start using disk-based memory, or run out of memory altogether, there are three possible solutions. One, if you have more memory in your system that's not allocated to the application, you can change the application's partition. In the Finder, select the application by clicking once on the icon. Select Get Info from the File menu. At the bottom of the Get Info window, are two boxes: Minimum size and Preferred size. Minimum is the smallest memory partition an application will launch with. Preferred is how much memory an application will take, if available. Increase the preferred memory setting to give an application a large share of your total RAM.

In the event that applications are still running out of memory, even with the largest partition possible on with your amount of RAM, you'll need more memory. Virtual memory or Connectix RAM Doubler are two cheap methods of expanding memory. Each has drawbacks, though.

Virtual memory is free (it's built into the system), but slow. Some applications can operate reasonably in virtual memory; others, such as Adobe Photoshop, are unusable with the system's virtual memory turned on. If you absolutely need more RAM immediately, try turning virtual memory on. Expect to see significant performance degradation, though.

Connectix RAM Doubler is much faster than virtual memory. Rather than storing data on disk, RAM Doubler compresses data within RAM in much the same way that Aladdin's StuffIt Deluxe compresses data on disk.

Giving An Application Too Much RAM

If an application's minimum size memory partition is larger than the available RAM, the application will not launch. The preferred size, however, can be set as large as you like. If the preferred size is larger than the available memory, the application will take all available memory. Having all memory allocated to an application doesn't leave the system in a very good position, though. The system allocates and frees memory as needed, meaning the system's RAM requirements may grow or shrink at any time. If there is no space left to grow into, operations may fail, or the system may crash. So what's the largest memory partition an application should have? Here's how to find out:

- 1 Quit all open applications. Only the Finder should be running when you're finished.
- 2 Choose "About This Macintosh" from the Apple menu. "About This Macintosh" should be the first item at the top of the Apple menu.
- 3 Observe the largest unused block size. On the right-hand side of the About This Macintosh window, you should see a number labeled "largest unused block." That's your total memory, less what the system and Finder are currently using.
- 4 Subtract one and one half to three megabytes from the largest unused block. This is dependent on how much memory you can spare. The more you can spare, the more room the system has to breathe. You now have a number which is the largest RAM partition you should give any one application.

Unfortunately, many applications access memory directly and don't like RAM Doubler getting in the way. Particularly with RAM-intensive graphics applications, RAM Doubler can cause erratic behavior and random crashes.

The best solution to running out of RAM, of course, is to get more RAM. No other solution can compare with the speed (and compatibility) of real RAM. And with RAM prices constantly dropping, it's easier than ever to add another 16 or 32 megabytes to any machine. The rest of this chapter will discuss various considerations to make when purchasing RAM.

Using RAM Effectively

Some people have to struggle with 16 or less megabytes of RAM, somehow managing to squeeze every bit and byte out to allow applications to run. Other people have all the RAM in the world, but don't bother to use it.

Too many times I've met people who, despite having close to a hundred or so megabytes of RAM, only allocate 4 to 6 megabytes to applications. Is it any wonder that those applications complain of running out of memory? No. I'm not surprised at all that problems are occurring. In fact, with a memory partition so low, I'd expect graphics and multimedia applications to choke. I'd also expect applications squeezed into such a small space to run slowly.

If memory is available, *use it!* There's no sense in investing thousands of dollars in RAM if applications are still forced to rely on their virtual memory schemes.

Finally, an excuse I've often heard for setting memory partitions so low is that applications can be hidden in the background while processing data, enabling the user to continue work in another application. If speed is an issue, forget this method. On the Macintosh, applications in the background run slower than applications in the foreground. The Mac delegates more processing time to the application you're actively using, thus slowing background processing. By putting an application in the background with a small memory partition, you're crippling it twice. In fact, you're also crippling the foreground application, which will be slowed by the background processing.

RAM Speed

Every RAM chip has a speed rating. The rating is measured in nanoseconds (ns) and usually ranges from 60 to 80 nanoseconds. The lower the number, the faster the RAM. Faster RAM usually costs a little more.

It's not always necessary to buy the fastest RAM possible. Some fast Macs will list a minimum RAM speed rating. The Power Macintosh 8100/80, for example, requires at least 80 ns RAM. Faster RAM can be installed, but slower RAM should not be. The minimum speed rating is related to the speed that the rest of the machine operates at. Purchasing faster RAM may give you a *slight* speed increase, but at considerably higher cost. I recommend purchasing the speed specified for your machine.

In fact, purchasing the right speed RAM is usually fairly simple. Power Macs that use SIMMs usually require 80 ns RAM. Power Macs that use DIMMs usually need 70 ns RAM. The table, RAM Speed Requirements for

RAM Disks

If virtual memory is disk-based RAM, why not make a RAM-based disk? With Apple's latest systems, you can. It's called a RAM disk and you can create it from the Memory control panel (see Figure 6.6). Of course, you need to have enough RAM to run the RAM disk and run applications, but the speed benefits are incredible.

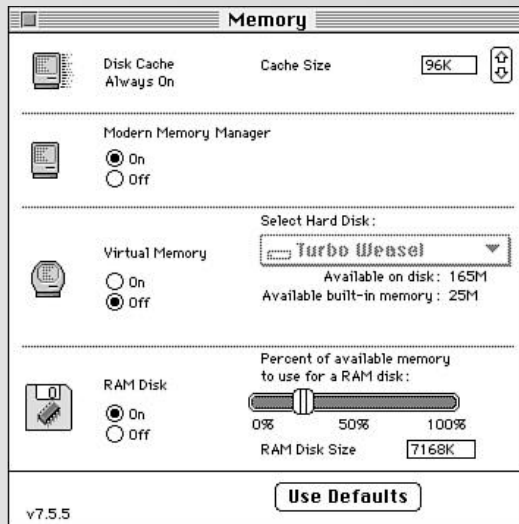

Figure 6.6

RAM disks can be turned on and off via the Memory control panel.

system is installed, the Startup Disk control panel enables you to specify the RAM disk as the startup volume.

One word of caution about RAM disks: since RAM is volatile and is erased when the machine is off, the RAM disk is erased whenever the machine shuts down. The system warns you before shutting down, offering the option to cancel. Data can be lost, however, if the system crashes or the power goes out. In such cases, you won't have the option of copying files from RAM disk to real disk. Thus, RAM disks are not a good place to store files or irreplaceable applications. All data stored in a RAM disk should also be stored on a real disk elsewhere.

As an example of what a RAM disk can do for you, I created a RAM disk on a Power Macintosh 8500/120. I installed a minimal system on the RAM disk and used the Startup Disk control panel to specify the RAM disk as the startup volume. To start off the RAM disk, I restarted the machine. The restart took a total of *five seconds* using the RAM disk, and once restarted, all system operations are accelerated. Launching and quitting applications is faster, drawing windows and dialogs is almost instant, even disk access is accelerated because no disk accessing is required for the system.

If you have the space, create a RAM disk from the Memory control panel. Select a size and restart the machine to activate the disk. After the disk appears, you can treat it just like a regular disk, installing a system or applications as you would any other disk. If a

Power Macs, shows the RAM speed needed for a range of Macintoshes. Double-check your machine, though. As machines get faster, RAM requirements most likely will change.

RAM Speed Requirements for Power Macs

Power Macintosh Model	RAM Speed Requirement
Apple Power Macintosh 6100	80 ns SIMM
Apple Power Macintosh 7100	80 ns SIMM

continues

RAM Speed Requirements for Power Macs (continued)

Power Macintosh Model	RAM Speed Requirement
Apple Power Macintosh 7200	70 ns DIMM
Apple Power Macintosh 7500	70 ns DIMM
Apple Power Macintosh 8100	80 ns SIMM
Apple Power Macintosh 8500	70 ns DIMM
Apple Power Macintosh 9500	70 ns DIMM
DayStar Genesis series	70 ns DIMM
Power Computing Power series	80 ns SIMM
Power Computing PowerWave	70 ns DIMM
Radius 81/110	80 ns SIMM
Radius System 100	80 ns SIMM

RAM Type and Interleaving

As mentioned earlier, RAM comes in two types: Single Inline Memory Modules (SIMMs), and Dual Inline Memory Modules (DIMMs). SIMMs and DIMMs are not interchangeable, so you must buy whichever type your Mac uses. DIMMs are faster than SIMMs, so machines that use DIMMs tend to be faster.

Interleaving is a process that can make either type of RAM operate faster (although interleaved DIMMs are still faster than interleaved SIMMs). Interleaved RAM is installed in pairs. That is, two RAM chips are installed at a time, matching in capacity and speed. Because the two chips are functionally identical, the Macintosh can then use the two chips together as if they were a single chip with twice the data capacity. More importantly, interleaved RAM has twice the data path, meaning information can be moved in and out that much faster. That's where the speed increase comes from.

Typically, Power Macintosh computers that use SIMMs *require* that the SIMMs be installed in pairs. Interleaving is a requirement on such machines because a single SIMM alone is not fast enough. Power Macs that

Disk Cache

At the top of the Memory control panel, there is a size setting for something called the disk cache. The disk cache is a place for the system to store information it has recently read from disk. If the information is needed again soon, it will be read from the cache rather than from disk.

Increasing the size of the disk cache can improve the performance of your Macintosh, especially if you repeat tasks or switch back and forth between applications. Of course, increasing the cache size reduces the amount of RAM available to applications, so don't go overboard with the disk cache size.

use DIMMs leave interleaving optional, if the feature is available. Thus, on machines that support interleaving and use DIMMs, interleaving will automatically switch on if RAM is properly installed in pairs.

If interleaving is an option on your machine, use it. The speed increase is significant. (If interleaving is a requirement on your machine, *use it!* The machine won't work without it.)

Cleaning Up Corruption in RAM

RAM is no more immune to corruption than the desktop database or files on a hard drive. In fact, RAM is probably more susceptible to corruption since the integrity of RAM is dependent on all the applications using it. If any application doesn't free its RAM properly or if an application quits because of a system error, portions of RAM can be temporarily inaccessible. Neither applications nor the system are able to access or use the RAM because it is still assigned to an application that's no longer running.

Determining whether RAM has been "lost" is a matter of checking RAM usage and free RAM. Your total free RAM should typically be a little less than the total installed RAM minus the RAM currently in use by the system and applications. If the amount free is significantly less than it should be, then some RAM has probably been lost. In Figure 6.7, for example, the total amount of RAM is 32MB. The system occupies 9MB, leaving a theoretical 23MB free. Yet, the largest unused block is only 15MB, indicating that 8MB have been lost.



Figure 6.7
The About This Macintosh window shows that 8MB are "missing."

Fortunately, because information stored in RAM is temporary, restarting your Mac will reset RAM. The reset should clear up any errors that had occurred previously. Figure 6.8 shows the result of restarting after the situation in Figure 6.7. Restarting not only recovered the missing 8MB, it also reduced the amount of RAM used by the system, leaving 24MB free.

It's not always convenient to restart so often, though. A small utility called Mac OS Purge from Metrolive Software can help you avoid restarting. Mac OS Purge attempts to reclaim any RAM which has been lost. It's not quite as effective as restarting, but it will save you a few restarts. There are situations, however, when restarting is a better way to go.

**Figure 6.8**

After restart, the missing RAM reappears, and the system partition is reduced.

When an application crashes, the rest of the system doesn't necessarily crash with it. The system reports that a system error occurred, resulting in the application's quitting unexpectedly. When such a situation arises, it is possible to continue working without restarting the machine. Despite that option, you're probably better off restarting anyway. Because the crashed application did not go through proper quitting procedures, there's no telling what was left in memory. Continuing without a restart might work out fine and no other problems will occur. It's likely, though, that other problems will arise out of the debris left in memory by the crashed application. Problems are particularly likely if you try to run the same application again. The application will try to access the same resources it was using before the crash. Since those resources may be corrupted, crashes are more likely. And generally, the second crash will be worse than the first, possibly requiring a forced reboot.

Zapping PRAM

Macintosh computers contain three separate types of RAM. The type of RAM used for the computer's memory is actually DRAM (dee-ram), which stands for Dynamic Random Access Memory. Because DRAM is the most commonly referred to, it is abbreviated to "RAM."

The second type of RAM is VRAM (vee-ram). The 'V' in VRAM stands for Video and that's exactly what it's used for. VRAM is used by the video display circuitry. That's why adding VRAM to a Mac increases the number of colors that can be displayed on the monitor and increases the size of the monitor on which those colors can be displayed.

PRAM is the third type of RAM and the most commonly overlooked. PRAM is Parameter RAM. It's where the Macintosh stores user settings, or parameters. Some control panel settings, for example, are stored in PRAM, along with internal information that the system keeps for its own use.

Like DRAM, PRAM is not immune to corruption. Over time, data stored in PRAM can become corrupted, leading to seemingly random or erratic system behavior. It's difficult to diagnose specifically that PRAM has been corrupted. The best solution when odd behaviors start appearing on your machine is to reset, or "zap," the PRAM and see if the problem goes away.

To zap PRAM, press and hold the keys \mathcal{H} -Option-P-R immediately after selecting Restart from the Special menu. Hold the keys until you hear a second startup chime. The PRAM has now been reset. Release the keys and let the Mac start. When you're up and running again, you'll have to reset some of your control panel settings, such as the computer's world location, selection color, and mouse speed.

When you use the system's method of zapping PRAM (the \mathcal{H} -Option-P-R method), the system keeps a small part of PRAM intact. This section contains information that's relevant only to the Mac itself, and doesn't really matter to the user. That section of PRAM, however, can still become corrupted. The only way to do a truly clean PRAM zap is with a program called TechTool (see Figure 6.9). TechTool is a free utility from MicroMat, which among other useful functions, can zap PRAM better than the system. TechTool wipes all the information in PRAM, erasing all possible corruption. I strongly suggest that everyone keep a copy of TechTool handy. It's an invaluable tool, and it's free, too.

NOTE

Some people suggest zapping PRAM several times in a row. The claim is that since zapping PRAM doesn't clear absolutely everything, zapping several times is more effective. Other people say zapping several times won't make any difference, because you're resetting the same piece of PRAM over and over again. So which is correct? I'm not sure if anyone knows. Resetting several times takes only a few extra seconds (just hold the \mathcal{H} -Option-P-R key combination until you've heard three or four startup chimes), so go with whatever you're comfortable with. If you want to be absolutely sure you've zapped the PRAM, you should use MicroMat's TechTool anyway. (If you do use TechTool, you only need to zap once.)



Figure 6.9

TechTool provides simple, but effective tools for zapping PRAM, rebuilding the desktop, and checking system integrity.

Hardware Accelerators

Hardware acceleration comes in two flavors: acceleration that affects all applications, and acceleration that affects only specific applications. Each flavor has its advantages and disadvantages, of course.

Generic, system-wide acceleration has the benefit of applying to all applications. You'll see increased speed in all areas of your work and productivity should increase accordingly. On the flipside, accelerating only specific applications will benefit only those particular applications.

Productivity in other programs will only increase as much as spending less time in accelerated applications leaves more time to work in the slower programs.

The advantage of application-specific acceleration becomes clear when comparing the degree of acceleration achieved by both methods. An application-specific accelerator can speed up that application far more than a system-wide accelerator can speed up the same application. For example, cards are available, which are designed to accelerate Photoshop operations. The speed gained in Photoshop from upgrading an 80MHz machine to 100MHz is negligible compared to the acceleration of a Photoshop card.

The method of acceleration you choose is dependent entirely on your work habits. Consider which applications your work revolves around. How much time do you spend in each application? Does your work center around one or two applications? Or does your work require many different applications? Read on to find out more about what options are available for each situation.

System-Wide Acceleration

System-wide accelerators are the economical route. More options are available that speed up your entire Macintosh, than are available for specific tasks. If your work spans a number of applications, you'll probably want to accelerate all or most of those applications.

Boosting Processor Speed

The most visible acceleration comes from increasing the speed of your microprocessor, or by replacing the processor entirely. Replacing the processor is the safest way to make a machine faster. Some new machines make the process easy by including the processor on a separate card. The upgrade is as simple as removing the old card and inserting a new one with a faster processor, or even multiple faster processors. If your machine does not have a removable processor card, it likely has a Processor Direct Slot, or PDS. The PDS is a place to install a card that communicates directly with the existing processor, or even takes over entirely, thus replacing the old processor. Most PowerPC upgrades for 68k machines work through the PDS.

68k to Power Mac Upgrades

Still hanging on to that old 68k based Mac? DayStar Digital makes it almost impossible to excuse not having a Power Mac for graphics work. By providing several paths for upgrading a 68k Mac to a Power Mac and all at reasonable prices, DayStar has removed many barriers to your getting a Power Mac. With more and more software being written exclusively for Power Macintosh, and with the incredible speed benefits provided by PowerPC-based computers, Power Macs are almost becoming a requirement rather than an option. If you're still hesitant to retire your old Mac, I strongly encourage you to investigate DayStar's offerings.

<http://www.daystar.com/>

DayStar Digital is the king of processor replacement. DayStar has long been a manufacturer of processor-replacing accelerators for both 68k Macs and Power Macs. Now that DayStar makes Power Macintosh clones, it seems appropriate that their machines have removable, upgradable processor cards. DayStar also worked with Apple to pioneer multiprocessor Macs. It is through the two companies' cooperation that multiprocessor upgrade cards are now available for all of DayStar's machines as well as some of Apple's machines. Processor upgrades from DayStar are both reliable and effective.

If replaceable processors are not your game, many people have success with increasing the speed of their current processor. This method is called "clock-chipping" and it works like this:

The processor in every Macintosh runs at a different speed from the rest of the system. Sometimes the processor runs at twice the speed of the rest of the computer; in other machines the processor is three times as fast. Because of the different speeds, a clock chip is used to keep the processor in sync with the rest of the machine. The clock chip simply maintains the speed of both halves of the computer. Replacing the clock chip with a faster clock chip causes the machine to run at an accelerated rate.

There are, however, certain risks involved with clock-chipping a machine. Although the speed benefits can be great, you should take caution if you do intend to clock chip your machine.

First, machines run at a certain speed because of theoretical limits. When processors are manufactured, they are tested to verify at what speed each chip can operate. Machines are then built based on the speed rating assigned to each chip. Clock-chipping a Macintosh may put your machine over its tested limit. Most clock-chipping kits provide a means to adjust how fast the processor runs. Take care not to run the machine too fast. Chances are, it will not function correctly if the speed is too high.

Second, processor chips have a limited life. The length of that life is in part determined by how hard the processor is worked. Forcing a processor to run at a higher speed than it was intended to run puts additional strain on the chip and shortens its life. The difference may be negligible. The processor will most likely be long outdated by the time it burns out anyway. But, if you are planning to stretch this machine for as long a life as you can, clock-chipping is not the way to go.

Finally, replacing the clock chip in a machine almost certainly voids the warranty. Most warranties are terminated if the machine is even opened. If modifications are made to the operation of the machine, not many technicians will take pity when the machine stops working.

Overall, I do not recommend clock-chipping your Mac. Although many people have performed the operation without error, the risks are great for minimal return. Clock-chipping is like an athlete using steroids to win a game. The immediate results may look good, but problems can occur down the road. I've heard one too many clock-chipping horror stories to risk my Macs with the same.

Boosting Video Speed

All the processor speed in the world won't help if you have to watch the monitor flicker as the video struggles to keep up with the processor's screen redraws. Having fast video is imperative for smooth, flicker-free QuickTime playback. Smooth scrolling of large images in Photoshop or Painter is invaluable for ensuring that no detail is missed. Accelerated video cards provide these functions and more.

Up until a few years ago, most Macintosh computers were capable of displaying only 256 colors at a time. To gain more colors, it was necessary to add an expensive video card. Most new Macs come with built-in video that can display millions of colors on monitors up to at least 16 inches in size. The catch is, built-in Macintosh video is *fast*. Unaccelerated third-party video cards flicker madly trying to keep up with the Mac's built-in video. As a result, you still need to buy an expensive video card if you want something better than built-in video. Cheaper, unaccelerated video cards just can't compare.

Fortunately, there are a number of accelerated video cards available. Radius, which absorbed fellow video card giant SuperMac, is one of the largest Macintosh video card manufacturers. Offering several levels of acceleration, Radius has cards for all graphics professionals. PCI Mac owners have an even wider range of options, because PCI is a standard on IBM-compatible machines. Manufacturers of PCI cards for PCs are finding it easy to adopt their cards to work on the Macintosh as well.

Some video boards combine several functions into a single card. The Matrox Millennium, for example, provides both accelerated video and QuickDraw 3D acceleration. The Thunder series by Radius offers the PhotoEngine, a Photoshop accelerator. By combining several acceleration options into a single card, you can maximize your value per dollar and save slots at the same time.

If you need more speed than built-in video provides, more color on a larger monitor, or even multiple monitors, you'll need a video card. Don't buy one without acceleration; you'll find it may even slow you down.

Application-Specific Acceleration

Suppose your work habits are such that you spend most or all of your time in one or two applications. Say, for example, that you're doing 3D animation in Specular Infini-D. Most of your time is spent in Infini-D, tweaking objects, adjusting animation, applying surfaces, and waiting to see what the changes look like. The largest delay is the feedback loop. How long does it take to find out what your changes look like? The sooner you can find out if your changes work, the sooner you can move on to another issue.

You could shrink the feedback loop by clock-chipping your 120MHz Mac to 132MHz and gain a slight speed advantage. Or, you could get a QuickDraw 3D accelerator and work with your objects shaded in real time, leaving little or no feedback loop delay.

A QuickDraw 3D accelerator is application specific. Because QuickDraw 3D is only used in certain applications, only those applications can benefit from the acceleration. The rest of the Macintosh will continue to operate at the normal speed.

Application-specific acceleration can provide phenomenal speed improvements in limited areas. Photoshop accelerators, for example, can provide many times the performance of an unaccelerated Mac, but only in Photoshop.

Consider application-specific acceleration if you spend a large part of your time in only one or two applications. If your work is concentrated in a few areas, you might consider two or more application-specific boards, provided you have the expansion slots available.

Software Optimization

All forms of optimization are, in some way, methods of making your software run faster. It's not *really* important how fast the processor is. It's how fast the processor runs the software that matters. Having hundreds of megabytes of RAM is useless if the software can't take advantage of it. What matters is getting the most out of your system and your applications, both by optimizing the software and by streamlining the way you work with it.

Faster Software

In most cases, speeding software is up to the developers of the software. Programmers are constantly developing new and innovative ways to make their applications process data faster, redraw the screen more efficiently, read and write to disk less often, or use memory more effectively. If a particular piece of code is holding up the rest of the program, how can that code be accelerated or eliminated?

That part of the acceleration is not up to the user. It's your job to keep your software up-to-date with the latest, fastest software. The biggest leap in software speed is likely to come with Power Macintosh "native" software. Whenever a product is released in a Power Mac native version or in a "fat binary" version, that's your ticket to faster software.

Native Software

To be "native" to the Power Macintosh means that the software was compiled into PowerPC assembly code. Because older Macs run on 68000 series chips, older software is compiled into 68k code. When run on a Power Mac, the 68k code must be translated into PowerPC code. Translating each instruction from 68k format to PowerPC format takes time, slowing down your machine.

Native software is not hindered by translation. Native software contains PowerPC code already, so instructions are sent directly to the processor.

The result is software that runs faster. Because the PowerPC is already a fast processor, native software is very fast.

Although the Power Macintosh is fast enough to emulate a 68k processor, 68K-based Macs are not fast enough to emulate a PowerPC processor. Consequently, Power Macs can run both Mac software and Power Mac software. 68k-based Macs can only run 68k software. The “fat binary” is the answer to this problem. Fat binary applications contain both 68K code and PowerPC code, enabling them to run on both types of Macintosh. Having twice the code also means fat binaries are rather large, though.

Which type of software should you be using? If you have a 68k-based Mac, the choice is simple: 68k software. Power Macintosh users should always use native software, if available. Otherwise, 68k software will work, albeit somewhat slowly. Fat binaries are fine for either type of Mac, unless disk space is an issue. Fortunately, there are a number of utilities available, such as Stripper by Chris Petersen, which can remove the unnecessary code from fat applications. In fact, unless your machine is a 68k upgraded to a Power Mac via a processor card (in which case you can switch back and forth between 68k and Power Macintosh), it’s probably worth your while to strip all your fat binaries of their other code half. The difference in size is considerable.

Bloated Software, Bloated Systems

One of the greatest developments in the software industry in the recent years has been the extensibility granted by plug-in architectures. The power and utility of both the system software, with its extensions, and applications, with various types of plug-ins, can be expanded immensely. But expandability can also slow you down.

My rule of plug-ins is simple: Use only what you need. Loading extensions that won’t be used is a waste of valuable resources. Even launching of applications is slowed by having to load a number of plug-ins. The rule applies to both the system and other software; overloading either one degrades performance and increases the risk of conflict.

Connectix Speed Doubler

When the Power Macintosh was released in 1994, Apple was praised for having emulated the 68k Macintosh so seamlessly on the new machines. Power Macs could run almost any 68k software, even though the machines ran on a completely different processor. Apple’s original 68k emulator, however, was relatively slow, running at approximately the speed of a midrange 68040 Mac. Connectix showed up Apple by writing a faster 68k emulator and bundling it with several other system-accelerating extensions. The result is Speed Doubler.

Speed Doubler consists of three parts: Speed Access, which accelerates disk access; Speed Copy, which accelerates file copying; and Speed Emulator, the new 68k emulator. Installing the first two extensions will accelerate any Mac. The third accelerates nonnative software on Power Macs only.

Overall, Speed Doubler is an excellent package and can make a significant difference in the speed of your Mac. Because large parts of the system software are not Power Macintosh native, Speed Emulator even accelerates the system. Speed Doubler, however, is prone to conflicts. Since all three parts of the bundle enhance or replace system functions, other applications may not interact properly with Speed Doubler. I recommend Speed Doubler, but use it with caution.

Viruses: Fact or Fiction?

When mysterious problems crop up or a machine seems to slow down without cause, many people jump to the conclusion that they've caught a computer virus, and that it's about to erase hard drives and fry hardware. The truth is, there are very few Macintosh viruses and even fewer malicious ones. Chances are the problems are the result of an extension conflict or extension overload.

Even so, viruses *do* pop up now and then. And, even viruses that are not intended to be malicious can cause problems. Their mere presence often interferes with the operation of other applications.

The best way to treat viruses is the same way you treat real viruses: Take precautions to avoid them to begin with. Cleaning up after a virus has already gotten in is much messier than keeping a virus out. After a virus is in, you may have to scan and disinfect every diskette or other removable media you own to eliminate all copies of the virus. You're better off just locking the viral door before anything gets in.

NOTE

Aren't viruses *supposed* to cause problems? Isn't that what viruses are all about? Not really. In fact, most viruses are meant only to propagate. The author is probably not the evil, hacker stereotype usually portrayed in movies. More likely they're curious to see what kind of an effect they can have on a digital society. At least one Macintosh virus was written by a high school student just to show that he could. None of this, however, should be taken as an excuse for writing viruses. Viruses are still an invasion of someone else's computer and cause problems whether they are meant to or not. However, Macintosh viruses are usually not the deadly, data-destroying diseases portrayed in the media. While care should be taken to prevent virus propagation, viruses are not something to lose sleep over. PC viruses are another story altogether. Just be glad you use a Mac.

Ratings

Virex	1	2	3	4	5
Ease of Use					
Great Features					
Coolness					
\$ Value					
Overall Rating					

Ratings

SAM	1	2	3	4	5
Ease of Use	████████████████████				
Great Features	████████████████████				
Coolness	████████████████████				
\$ Value	████████████████████				
Overall Rating	████████████████████				

A number of software packages are available that will both protect against viruses and eliminate existing viruses. Symantec Anti-virus for Macintosh (SAM), Datawatch Virex, and John Norstad's Disinfectant are the three most popular packages. Each one offers a number of useful features and effective protection.

Virus protection happens in one of two ways: passive or active. *Passive virus* protection means that the computer quietly sits waiting for signs of viral activity. The user is not bothered, because no viruses are present. *Active virus* protection is more visible. Programs, such as Virex, actively scan for viruses every time a disk is mounted. The user must stop to wait for the scan to complete even when nothing is wrong.

My personal choice for virus protection is Disinfectant (see Figure 6.10). Not only has John Norstad done the Mac world a favor by making Disinfectant completely free, his use of passive protection also makes the software completely transparent. Install the Disinfectant Protection init after an initial scan for viruses and you won't hear from Disinfectant again until a virus tries to get in. Disinfectant then steps in and informs you of the presence of a virus, even preventing infected applications from running. And when new viruses are discovered, Disinfectant is updated and distributed via online services within hours. For cheap, extremely effective protection, Disinfectant is an excellent choice.

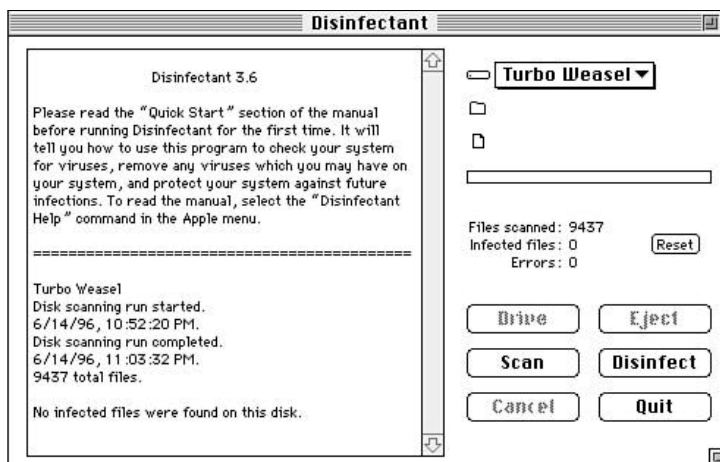

Figure 6.10
Disinfectant's simple interface and extensive documentation makes transparent protection from viruses easy.

Ratings

Disinfectant	1	2	3	4	5
Ease of Use	████████████████████				
Great Features	██████████████████				
Coolness	██████████████████				
\$ Value	██████████████████				
Overall Rating	██████████████████				

In the end, use whatever software makes you feel most comfortable. If viruses worry you, active scanning offers more assurance that nothing is wrong. Commercial packages also tend to offer more comprehensive protection and even network administration of virus scanning. To keep virus scanning out of the way, go with Disinfectant and let the protection occur behind the scenes.

NOTE

Disinfectant protects only against viruses that infect the system and applications. Other types of viruses infect files, such as HyperCard viruses and Microsoft Word viruses. For protection against those types of viruses, and against trojan horses (a virus disguised as an application), you'll need to purchase a commercial virus protection package, such as Datawatch's Virex or Symantec's SAM.

Working Faster

After the bottlenecks have been eliminated from the system, the conflicts have been worked out, and viruses cured, it's time to streamline your work process. By automating, optimizing, and organizing, you can improve your overall productivity. Be careful, though. It's easy to get so swept up in automating and optimizing that real work is forgotten.

Automating Your Work

Part of speeding up any process is looking for repetition. Tasks that are performed over and over again in exactly the same way can be examined and optimized. In the case of optimizing work habits, if any repeated task is quantifiable into a series of discreet steps, it is possible to have the computer perform those steps for you. Not only can the computer perform the same tasks faster, it doesn't run the same risk of error that a human operator does.

One of the challenges of working alone is finding out if you are on track with a solution or if you have really gone around the bend.

Stephanie Peters, AIGA

Automation can be as simple as a signature on email (a commonly automated task), or as complex as batch processing a series of image files and compressing them for storage. The Macintosh provides several means for automating your work and third-party utilities enhance the possibilities even further. Be warned, however, that most automation utilities employ some form of a scripting language. Even if a utility can automatically record actions, the real power of automation is unlocked through the scripting language. You can benefit from automation utilities without learning the language, but you can't fully exploit their power without manual scripting.

AppleScript

AppleScript is Apple's main utility for automation (see Figure 6.11). In order for AppleScript to work its magic, though, applications must be written to understand it. When that is the case, AppleScript can perform complex operations that go far beyond simple mouse clicks and menu choices. AppleScript can change Finder and application preferences, communicate between applications via AppleEvents, modify files, and execute application-specific operations. Applications can even be written to allow AppleScript recording: You show AppleScript what you want it to do and AppleScript records your actions, automatically generating a script. And AppleScript will continue to evolve in the future, becoming even more powerful and diverse. If you want to learn how to really make your Mac work for you, AppleScript is your solution.

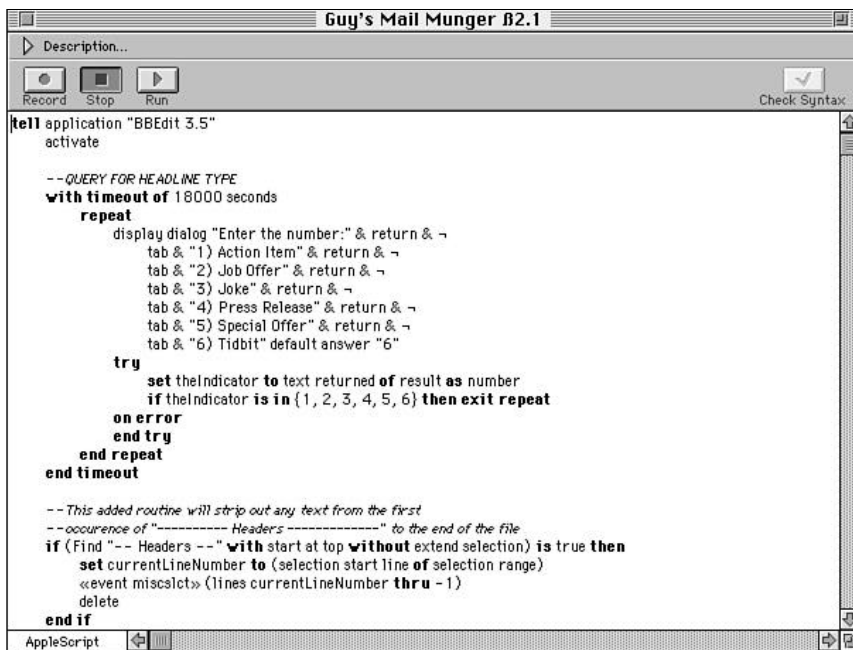

Figure 6.11
AppleScript is a very powerful means to automate the Macintosh. This AppleScript processes text files.

Other Automation Software

If programs are not written to take advantage of AppleScript, you'll have to use another application, such as CE Software's QuicKeys. QuicKeys enables you to define macros that can be played back with a few keystrokes.

Suppose, for example, you want to create an icon representation for each of a series of images. QuicKeys can record the process of creating the icon for the first image: Scale image 50 percent, crop, add border, save as, close image. After the script is saved, you need only open an image and press a few keys to create an icon representation.

TIP

For more information on AppleScript, pick up a copy of *The Tao of AppleScript* also by Hayden Books.

Ratings

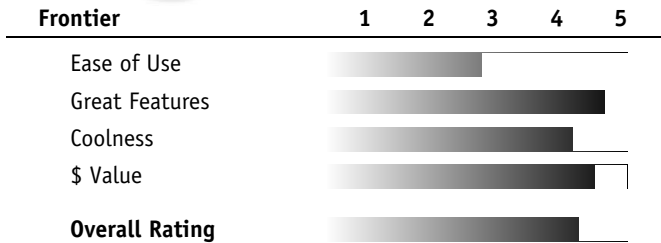

I loved Now Utilities, but I have endured so many weird system crashes that I had to start jettisoning inits, and Now Utilities had to go. Sigh.

In my experience, automation has been most useful for HTML tags. Many automation utilities are capable of asking the user for information during the execution of a script. Using OneClick, a scriptable utility from WestCode, I've put together scripts that automatically create Web pages for me. One script inserts header and footer information for me. Another creates tables to my specification and inserts information in each cell. A third script can insert

list entries into a news page, even labeling each entry with the current date. This sort of automation frees me to think about what goes into a Web page, rather than fiddling with how to make it happen.

Optimizing Your Work

In addition to automating your work, a number of utilities help to streamline the operation of your Macintosh. Such programs simplify some common tasks and invent new ways of doing other tasks. Ranging from changing monitor bit depth to adding menus to the Finder, optimizing your work style can make digital life much easier.

NOTE

Be careful with QuicKeys. Because each macro is assigned a key combination, it's easy to overwrite a key combination already implemented in another application. Word processors, such as WordPerfect, tend to have many hidden key combination shortcuts to menu items and actions. QuicKeys can do wonderful things, but make sure you're not blocking out other useful shortcuts that are already defined.

Ratings



Ratings

AppleScript	1	2	3	4	5
Ease of Use	██████████				
Great Features	██████████				
Coolness	██████████				
\$ Value	██████████				
Overall Rating	██████████				

Now Utilities

Now Utilities from Now Software is the classic Macintosh interface-enhancing utility package. Now Utilities provides more interface improvements than I could name (see Figure 6.12). From the subtle capability to click a background window to aid navigation in open/save dialogs to the powerful and not-so-subtle Now Menus control panel, Now Utilities has something to improve your work. The folks at Now Software have clearly thought out every aspect of the Macintosh interface and found ways to improve almost every area. Apple has even adopted several interface ideas pioneered by Now Utilities.

Now Utilities—Mighty, mighty, mighty. Now Menus and Super Boomerang alone—EACH alone is worth the price. Startup Manager ain't bad at what it does, either.

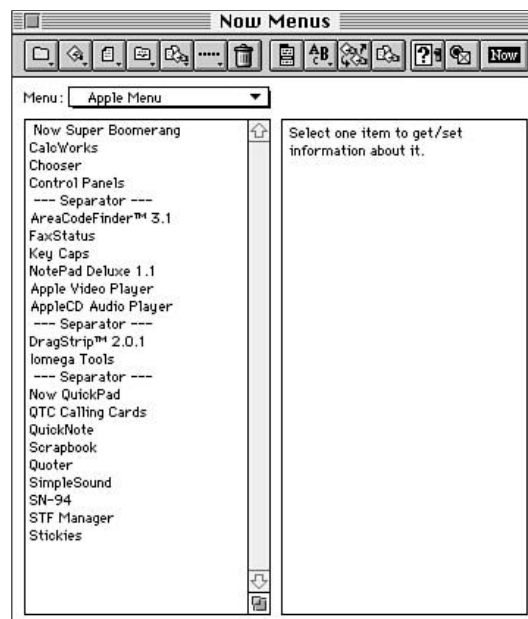

Figure 6.12
Now Menus is a powerful part of the Now Utilities package that extends the capabilities of menus.

Aladdin Desktop Tools

Originally a shareware product, ADT (Aladdin Desktop Tools) by Aladdin Systems is carefully designed to work with Now Utilities (a clever piece of marketing on the part of Aladdin Systems). Some of the two packages' functions overlap, but are written so as not to interfere with each other. If you absolutely need some functions from both products, you can safely run them. You might run out of RAM, though; both packages tend to use more than their fair share of RAM.

Control Strip

Introduced originally with PowerBooks, Control Strip is an invaluable tool for instant access to a number of system functions, such as changing sound volume or monitor resolution and bit depth. With the release of System 7.5.3, Control Strip is available on all Macintosh models (see Figure 6.13). Control Strip has two important features that make it a useful product: It's extensible, so third parties can write their own plug-in Control Strip buttons, and it can be invisible. One of the problems with system enhancements is that they sometimes get in the way. Because other applications may not be aware of the presence of enhancements, the applications won't compensate for changes made to the system. Thus, Control Strip's capability to disappear on command is important. Through the Control Strip's control panel, I've assigned an F-key to toggle visibility. On command, the strip will pop up, enabling me to turn on or off file sharing, connect to the Internet, or even check the battery level in my PowerBook. When finished, a single keystroke hides it away again. I find this capability especially useful when working in graphics programs. I need all the screen real estate I can get to display graphics. Everything else needs to get out of the way.



Figure 6.13
Apple's Control Strip enables instant access to system functions.

I must warn again of the importance of not installing what you don't need. I find Now Utilities and Control Strip invaluable. You may disagree or find that you simply don't need them. Don't let any utility use more RAM than it is worth. If the return is not worth the RAM used, unload the extension.

Organizing Your Workspace

All the automation software in the world won't help you sort through a disorganized computer. Applications and files scattered randomly about the hard drive and desktop make finding what you need a difficult task. Before forgetting the color of your desktop pattern under a pile of windows and files, take some time to organize.

Aliases

Apple's best built-in organizer is aliases. An alias is a tiny file that points to another file stored elsewhere on disk. Aliases can point to any file or application, anywhere on your computer, on removable disks, or even on other machines on a network. Thus, aliases enable you to organize files and applications in whatever way best suits you, even if that means putting a link to Fractal Design Painter in every folder on your hard drive.

Aliases also eliminate unnecessary folder navigation. I store all of my graphics applications in one folder. Each application is contained in its own folder with support files, plug-ins, and the like. Rather than navigating down into each application's own folder, I create aliases to each application and store them in another folder. I can then hide the actual application folders anywhere on my hard drive, out of the way. To launch Specular Infini-D or Equilibrium's DeBabelizer, I just have to open a single folder, my graphics folder, and double-click an alias (see Figure 6.14).

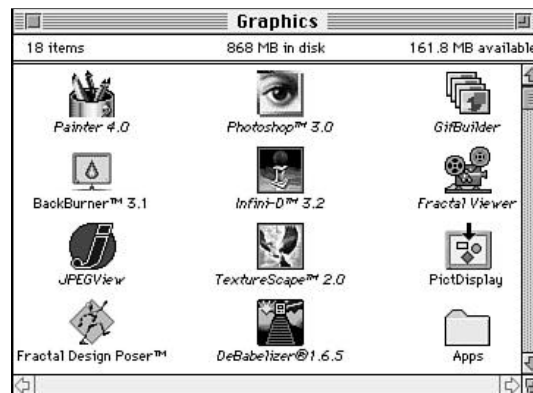

Figure 6.14

In this graphics folder, applications are hidden in subfolder, Apps, and referenced by aliases.

The Apple Menu

The Macintosh system has another mechanism built-in, which lends itself particularly well to organization: the Apple menu. Since the release of System 7.5, the Apple menu has had built-in hierarchical menu capabilities (before System 7.5, third-party utilities, such as Now Utilities, provided this

function). Folders placed within the Apple Menu Items folder are automatically turned into hierarchical menus. By using aliases and nested folders, the Apple menu turns into an instant access file and application organizer (see Figure 6.15).

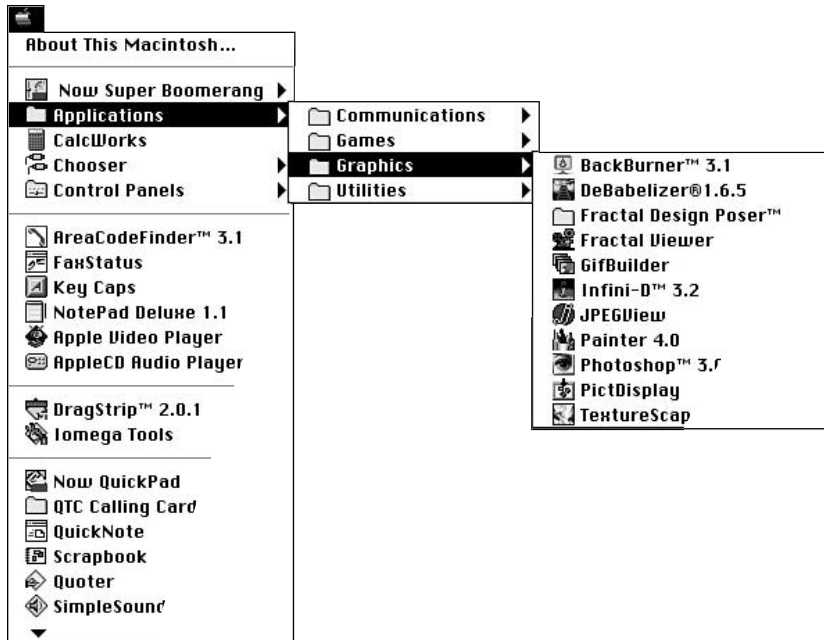

Figure 6.15

Nested folders and aliases can be used to organize applications and access them quickly.

Button Bars

Button bars are a recent fad in Macintosh interface enhancements. I say they're a welcome addition. Button bars are configurable palettes of buttons. The capabilities of the buttons vary from product to product, but typically they act like aliases, enabling the user to launch applications and open files or folders with a single click. The advantages of button bars over a folder full of aliases is in size and availability.

Button bars usually take up less space than a standard window. The bar floats over other windows in some cases and in others can be called to the front quickly. Making the buttons so easily available means you can get to files and applications faster. And with drag-and-drop, some button bars can even act as a conduit between applications when screen space is tight.

The most powerful button bar comes from a company called Natural Intelligence. Their button bar, DragStrip, is the most full-featured application-launching utility I've seen (see Figure 6.16). With full drag-and-drop support, application switching hot keys, fully configurable multiple button bars, and myriad other features, DragStrip is well worth its low price. With a free demo available, you can even try out DragStrip before you buy it.

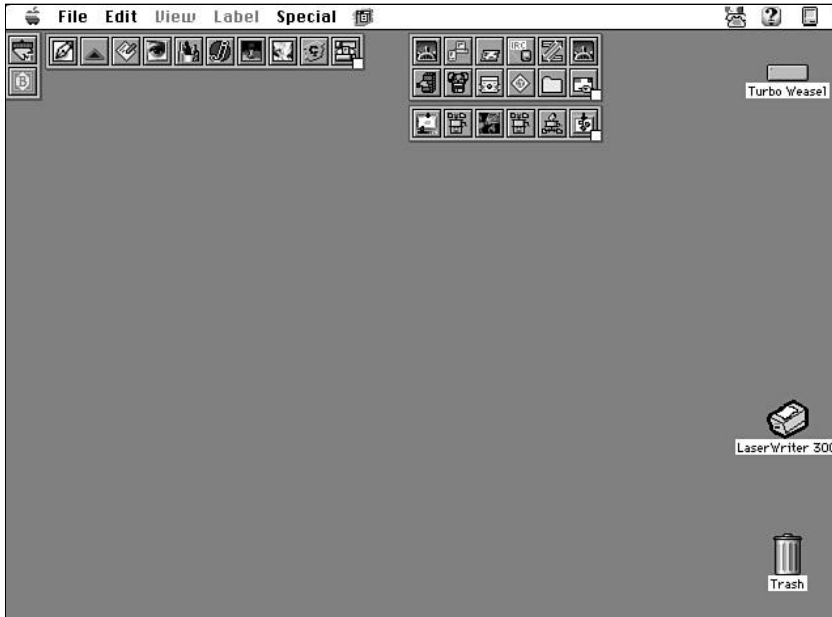

Figure 6.16

DragStrip can display multiple unique button bars and Control Strip modules, and provides application-switching capabilities.

If you're looking for something a little simpler, PowerBar is a shareware application that will satisfy most users' button bar needs. PowerBar was one of the first button bars available for the Mac and its feature set has grown steadily.

OneClick: The All-Purpose Automating-Optimizing-Organizing Tool

OneClick, from WestCode Software, is like a Swiss army knife; it contains a whole lot of tools for almost every need (see Figure 6.17). OneClick is essentially a button bar, but with far more power hidden beneath the surface. On the surface, OneClick provides buttons that can launch applications and files. OneClick also contains a powerful scripting language. Scripts are assigned to buttons in much the same way the CE Software's QuicKeys assigns scripts to keys. OneClick buttons can also contain tools similar in function to the Control Strip's modules (DragStrip actually supports Control Strip modules directly).

As if that weren't enough, OneClick button bars are application specific. You can assign a specific set of tools to a button bar and then instruct that bar to only appear when a certain application is launched. For example, create a set of scripts for use with Photoshop. That bar can then be told only to appear when Photoshop is opened. And any button can even contain another button bar that pops up like a menu when clicked.

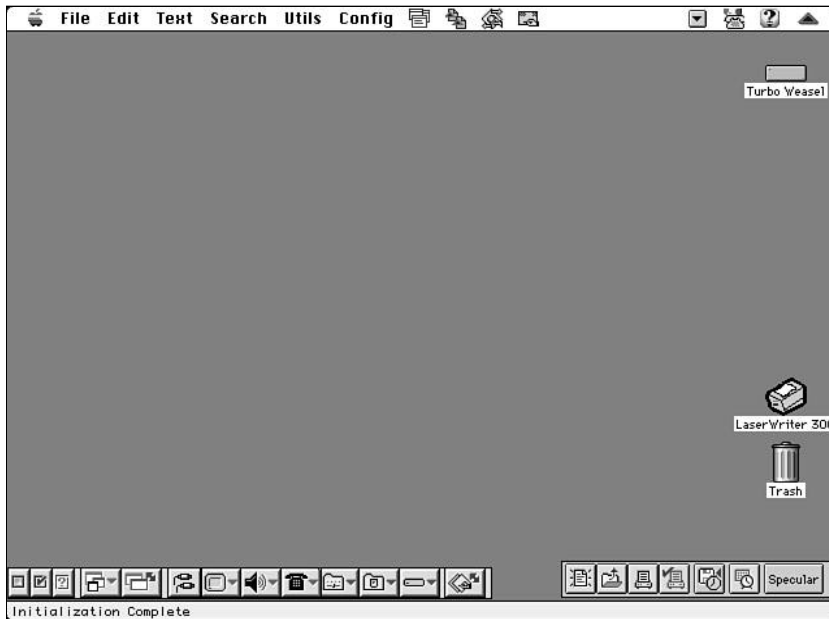
**Figure 6.17**

OneClick is an all-in-one organizing, optimizing, and automation tool with button bars, system controls, and a built-in scripting language.

How much would you pay for this wonder tool? Well, hold on a minute before you place your order. Because OneClick covers so many bases, some of those areas suffer in terms of functions or interface. I prefer DragStrip as a straight button bar. DragStrip is tuned for one specific purpose and does that very well. OneClick's capabilities may be enough for you, or some of its many other features may make the package worth your while. The bottom line is, use what works best for you. The point is to increase your productivity, so go with what you like. I usually mix and match parts of utility packages to find exactly the combination of tools I'm looking for.

7

Choosing A Macintosh Model

In 1984, choosing a Macintosh was easy. There was only one Mac, and it came in only one configuration. You got a nine-inch black and white screen, 128KB of RAM, a mouse, a keyboard, and some software. Worrying about buying video cards or accelerators was not an issue, because there were no expansion slots.

Today there are many different models from which to choose. Different processor speeds, types of and amount of RAM, expansion slots, and video capabilities all make choosing a Mac much more complicated. What's more, Apple is no longer the only manufacturer making Macs, thus widening the options dramatically.

Choosing a particular model to suit your needs can be a daunting task. Like buying a car, a Mac is something that will stick with you for a while. But at the speed that technology advances, there's always another machine coming in a few months that will outclass today's machines.

This chapter provides you with some guidelines for selecting a Mac that adequately suits your needs and hopefully won't empty your wallet.

If you want to know...	Go to...
How fast should the microprocessor be?	136
Take a closer look at your purchasing options.	145
Should I buy a clone?	142
Specifications on Macintosh models.	145
What do I need to know about buying peripherals?	147
Will I need to expand my Macintosh?	139
What size hard drive should I buy?	139

Determining Need

In a perfect world, we could all have the fastest Mac, stuffed to the gills with RAM, driving a huge monitor with blazing redraw speeds and millions of colors. This machine would have all the video input/output capabilities anyone could ever need and a hard drive that never filled up. Unfortunately, most of us don't live in that world and have to temper our desire to build a dream machine with the size of our wallet. So, in order to get the most you can for your money, you should first determine how much power you actually need.

Try not to get caught in the position of having to try out every piece of neat software on the market. (Like me;-)) If you don't know your few key pieces of software well, you'll probably take a lot more time than it should to complete your work. In the end, this will probably lose you a lot of money.

Marc Beauregard
Redhead Racing & Creative
Services

Finding a Balance of Features

Finding the ideal machine is a matter of trading capabilities for other options. One machine, for example, might come with 2 gigabytes of drive space and 64MB of RAM. Another machine might come with only one gigabyte of drive space and 32MB of RAM. The second machine, however, comes with a faster processor, meaning the machine processes data faster. Because RAM and hard drives can be upgraded, you might opt for the faster processor. But if RAM and disk space are more important than having the fastest machine, the first choice might be better, since the RAM and hard drive are already installed at a good price.

Microprocessor Speed

Both the speed and the type of microprocessor determines how fast your machine is and, consequently, how fast you can work. The first level of processor choice is easy: buy PowerPC machines. 680X0-based (68k) machines just aren't fast enough to keep up with today's creative professional. That's why Apple chose to switch to the PowerPC originally, and that's why you should choose to switch also.

After you've chosen PowerPC, however, the decision is somewhat tougher. Look at the speed rating of the chip, but don't take that as the absolute speed of the machine. Within a single series of chips, the chip with the higher speed rating in megahertz (MHz) is the faster chip, but between different chips, the speed rating is less important, because different types of chips use different methods of calculation. The PowerPC 603e, for example, is a low-cost, low-power microprocessor, and although performance is good on the 603e, it cannot compare to the higher-priced, high-performance PowerPC 604. A 603e running at 120 MHz is fast, but a 604 running at 120 MHz is faster. If you're looking for decent performance at a good price, look at 603e machines. If your work requires blazing speed, check out 604-based machines.

Buying Obsolescence

If you've ever asked anyone for advice on buying any computer, you've no doubt heard someone reply, "Just wait six months, and there will be this new computer released that's going to make current computers obsolete!" So you wait. Six months later the new computer is released, and in another three months it is made obsolete by another, fancier computer.

The fact is, whenever you buy a computer, you're buying obsolescence. No matter how fancy or fast a machine is, another will come along that is fancier and faster. Unless you have the money to buy every new machine that comes out, you won't be able to keep up.

So the question is, how long can you wait? There might be a new computer coming six months down the road that outclasses current computers in speed or features, but as long as you wait for the next computer, you don't have the computer you need. And when the latest computer is released in six months, there will be another coming down the pipeline.

At some point, you'll have to dive in and buy a computer. Whatever you buy, expect that a better, faster computer is coming, but buy as much computing power as you can when you do buy. It will last you that much longer.

Finally, there's one last detail to look for in the processor of a Mac. Is it upgradable? Many new Macs have the processor located on a card separate from the motherboard of the machine. If you think you can live with whatever processor you buy for a while, don't worry about upgradability. If you think you'll want to upgrade to the latest, greatest processor when it becomes available, look for a processor that's located on a separate card.

So what's the final word? A fast 603e processor will handle most multimedia tasks adequately. The 601 processor is generally a little faster, but costs a little more. Most new high-performance machines come with the 604, and the speed increase is well worth the added cost. If you can afford it, you won't regret investing in a 604-based machine.

Memory Size

The rule of RAM is the more you can get, the better off you'll be, especially when working with graphics and multimedia. Remember, though, that you always can add more. You might get slightly lower prices if RAM is purchased with the machine, but it is better to buy a fast machine and upgrade the RAM when you can. And in a market where the prices fluctuate on a daily basis, you might end up getting twice the RAM for half the price further down the road. There are, however, still a few other considerations regarding RAM.

First, there are two types of RAM that Macs use. Single Inline Memory Modules (SIMMs) are the older style used by first generation Power Macs and a few later models. Dual Inline Memory Modules (DIMMs) are the new, faster RAM chips. DIMMs have twice the data path and can move information in and out faster. If possible, get a machine that uses DIMMs. The speed difference is significant; the price difference is not.

The Need for Speed

So what's all this fuss about fast machines? Only a few years ago, everyone was working quite adequately on 68k-based machines. In comparison with today's machines, 68k models creep along at a snail's pace. Even redrawing the screen takes a noticeable amount of time. What's so fantastic about the PowerPC?

Since the dawn of the computer age some 40-odd years ago, users and programmers have always been able to find a way to use all the processing power of a machine, leaving them yearning for more. When personal computing began with the Apple IIe, clever users managed to extract every possible bit of processing power for then-state-of-the-art graphics. The introduction of Macintosh boosted the graphics field even further, and each successive generation of Macintosh has encouraged the growth and evolution of the computer graphics industry. The Power Macintosh was a truly remarkable milestone that opened up new worlds to graphics and multi-media producers. The introduction was ideal as it came just as the older 68k series of chips was nearing its theoretical maximum performance.

So what does all that mean to you? The faster your machine is, the less time is spent waiting for the computer to catch up with what you do. You spend more time working, figuring out what to do next, and where to go with your artwork. There's nothing more frustrating than twiddling your thumbs while the computer is tied up.

Photoshop operations happen much faster, enabling you to see the results sooner. Many programs written for PowerPC have real-time feedback capabilities, something not possible on a slower machine. In Bryce 2, for example, you can sculpt mountains in real time, watching hills and valleys form as you move the mouse. Technologies, such as QuickDraw 3D, are only possible because of the speed of PowerPC machines. And the faster the PowerPC is, the faster QuickDraw 3D runs, offering you real-time shaded 3D models. PowerPC machines can save hours of rendering time on more complex 3D scenes.

All this speed translates to increased productivity for you. With instant feedback, you can find out sooner whether your layout works or the colors are correct. The sooner you can correct the problem, the sooner the project can be finished. Editing QuickTime movies and applying effects happens in half the time it takes older machines, meaning you can check your cuts, resynchronize the audio track, tweak a filter's effect, and move on to the next problem.

The bottom line, of course, is income. The more creative work you can do, the more you can get paid. Clients don't pay you to sit and watch while your computer crawls through the rendering of an animation. Clients pay you for your time spent creating graphics, animation, audio, video, interactive applications, and more. If the computer can keep up with you, you can keep creating.

Second, whether you're using SIMMs or DIMMs, find out if the machine you're interested in can do interleaving. *Interleaving* is a process where the computer uses matched pairs of RAM chips together as if they were one chip with twice the data path. That means memory access is considerably faster. First generation Power Macs required that SIMMs be installed in pairs. That was because interleaving was required, not optional. Newer Macs, such as the 7500, 8500, and 9500, have the option of interleaving. If you install memory chips in pairs, the computer interleaves them automatically. If memory is not installed in pairs, interleaving does not take place and the machine will be slower. Other machines, such as the 7200,

are not capable of interleaving. Check with your machine first, then buy RAM accordingly.

Expanding Your Mac's Capabilities

All Macintosh models have limits on what they can do. Built-in video, for example, can only handle monitors up to a certain size and at a limited number of colors. If you have a larger monitor or need to display more colors at a higher screen resolution, a third-party video card must be installed. For video capture and output, a third-party video card may be necessary. QuickDraw 3D can be accelerated by adding a card, and accelerator cards are available to speed up Photoshop functions. Macintoshes have a limited number of slots, however, so you need to plan ahead for what you might need in the future.

When looking at a particular Macintosh model, look at the number of slots for cards and make note of what type of slot the Mac uses. Older Macs accept NuBus cards. Newer Macs are switching over to the faster, cheaper PCI-style cards. If you have already invested in NuBus cards, it might be worth your while to look for a new Mac that can still accept the cards. For faster performance, go with PCI. PCI also is used in the Wintel (you know, Windows and Intel) world, so the cards tend to be cheaper. If you need the best of both worlds, Power Computing makes a Mac clone that supports both PCI and NuBus.

Finally, be sure to look at what options a Mac comes with and if it can be upgraded. If you know that the Mac's video isn't good enough, don't pay for it. Get a Mac, such as the 9500, that doesn't have built-in video. Instead, the 9500 provides more expansion slots to incorporate your own video card. The same is true for video capture and output: if the video capabilities of the 8500 aren't sufficient, getting a 9500 means you won't be paying for hardware you won't use. Power Computing machines typically are tailored specifically to your needs, so you can buy exactly the machine you want.

Storage Space

Much like RAM, hard drive space is always short. Graphics and multimedia files take up huge amounts of space on disk, even with compression. What's more, most graphics packages need large quantities of free disk space in which to work. Such programs temporarily store information on disk when not needed in RAM. Having enough disk space to store saved files and still have space free for temporary *scratch* files is a tricky balance. Fortunately, hard drives are getting steadily cheaper.

TIP

For graphics and multimedia work, assume a 32MB minimum. At 32, you should be able to work comfortably. You can get by on less, but expect to feel a little cramped.

**Figure 7.1***Apple Power Macintosh 7500/100*

New Macintoshes come with internal hard drives ranging from 500 megabytes to 2 gigabytes in size. For multimedia work, getting the largest drive is usually a good idea. If you know you'll need more (and chances are high that you will), consider a smaller internal drive in favor of adding a larger external drive later.

Don't buy the smaller drive, however, without first considering the access speed. In order to move large quantities of data quickly, a hard drive must have fast access times. Newer Macs have a faster internal SCSI (pronounced "scuzzy") bus than the external SCSI bus. Thus, if a hard drive is added to the external SCSI port, it most likely will be slower than a hard drive inside the Mac. Some Macs, such as the 8500, 9500, and some clones, have one or more extra drive bays where additional devices can be connected inside the Mac and will use the faster internal bus. If you're going to add a hard drive later, look for a Mac that has space inside to do so.

If expandability is a requirement, removable drives are invaluable. Again, the internal SCSI bus is faster, so consider a Power Computing Mac clone, which gives you the option to have an internal removable drive, such as Omega's popular Zip drive.

Finally, cards are available to make external drives as fast as or faster than internal drives. When internal drive bays are not an option, or if they're already filled with other devices, look for a machine with enough slots to allow room for an SCSI-2 card. In some cases, such as FWB's Sledgehammer, a card is provided with the hard drive. In such a case, the PCI/Nubus question comes up again. Go with PCI if you need the maximum speed.

NOTE

SCSI (Small Computer System Interface) is the interface the Macintosh uses for accessing devices such as hard drives and CD-ROM drives.

No matter which way you choose to assemble your drives, 1 gigabyte is a about the minimum for graphics work; 2 gigabytes is more comfortable. Remember, though, that adding more space after you purchase your machine can be as simple as plugging in an external drive. In general, don't sacrifice RAM or speed for hard drive size.

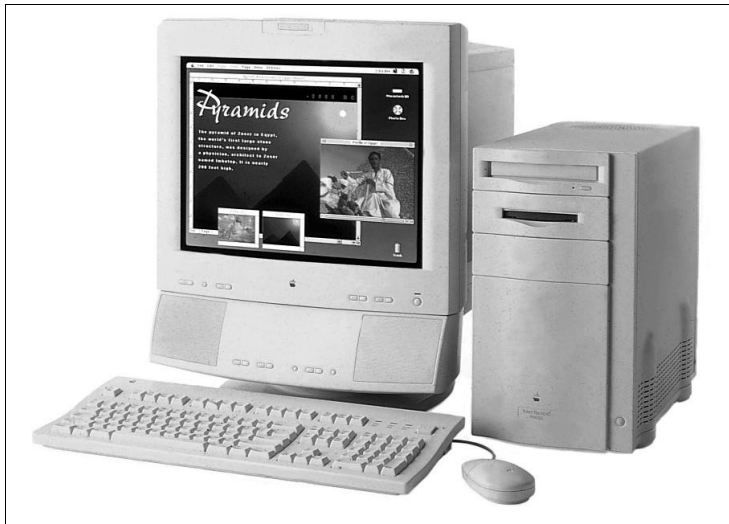

Figure 7.2
Power Macintosh 8500/100

Order of Importance

It's easy to say that the faster a machine is and the more RAM it has, the better off you are. Add a large hard drive, numerous expansions slots, and an enormous monitor for a fantastic machine that only an elite few can afford. The rest of us have to rank the various parts of a machine in order of importance. Which aspects are of most immediate relevance? As a professional Mac artist, here's how I rank machine factors when considering purchases:

- Processor speed is probably the most relevant. The processor is the heart of your machine and ultimately determines how fast operations occur. Other parameters play a part in determining speed, but the bulk of it lies in the speed of the processor. Some processors are upgradable, but there are not a lot of options or configurations for processor upgrades. Buy a machine with a processor that will last a while. For the most part, when it comes time to make the next speed leap, you'll probably replace the whole machine.
- RAM takes second place. It's difficult to judge just how much RAM you'll need before using the machine. My recommendation is to start with a minimum of 32MB. RAM always can be added later as programs begin to run out of RAM or use scratch disks extensively.

continues

continued

- Expandability and built-in features go hand in hand. If a machine has all the features you need built in, you won't need to add cards. On the other hand, if you need more features, you need a few expansion slots in which to put cards. Consider this option carefully. You can't very well add more slots to a machine. When they're filled, you're out of room.
- Hard drive size is less important than drive speed. Hard drives have the advantage of being able to store data in many formats, including highly compressed formats, if need be. Hard drives are cheap as well, so more can be added if space is tight. Drive access speed, however, cannot be boosted much, so look for low access times.
- Finally, consider ease of expansion. Although user interface with the innards of a machine is less important than user interface with the software running on the machine (we've already determined the importance of good user interface; that's what the Mac OS is all about), it should not be overlooked. How easily can you get in and out to install RAM and expansion cards? I rank this one last, however, because computers are used more than they're disassembled, but when the time comes for an upgrade or a repair, you will be glad that you thought ahead.

You might rank these options in a different order depending on the type of work you're doing. 3D graphics rendering, for instance, is affected by different factors depending on how you're rendering. Ray tracing speed depends mostly on the speed of the processor, whereas shading speed is subject more to the amount of installed RAM. Photoshop and other 2D applications are affected by both processor speed, RAM, and hard drive speed. In this case, you might rank processor speed lower and expandability higher, because a Photoshop accelerator card might be on your shopping list. In other words, take my advice as a recommendation, not a rule, and consider your work as the most important factor.

Many Makers of Macintosh

For the first 10 years of Macintosh, there was only one maker: Apple. Meanwhile, PC users chose from a plethora of manufacturers, mixing and matching to build exactly the machines they wanted. As a result of this severe imbalance, PCs were very cheap because of intense competition, whereas Macs were more expensive because there was only one brand. Mac users chose from the models Apple offered and upgraded from there. All in all, there weren't a lot of options.

Now, after years of urging, Apple has finally let go and allowed other companies to manufacture Macintosh *clones*. What this means to the user is more choice, lower prices, and the option of buying exactly the machine needed. Slowly, more and more companies are signing on to build Macs, and as they do, the choices get better and better.

Some people remain fiercely devoted to Apple. In fact, Apple has a more loyal following than any other computer manufacturer. If you're one of those faithful Apple fans, don't worry; Apple has more Macintosh choices than ever. But if you're willing to look around, there are a number of innovative, high-quality Mac clones available.

Power Computing

Foremost in the Mac clone field is a startup company called Power Computing. Power Computing was the first company to release a Mac clone, and it remains one of the largest sellers of clones. Power Computing offers many choices in terms of processors, RAM, drive size, and expandability. Because the machines can only be ordered directly from the company itself, Power Computing will custom configure a machine exactly to your specifications. If you want to buy a machine and not have to worry about adding peripherals in the near future, take a look at what Power Computing has to offer. Their prices are usually lower than Apple's, and they offer incredible software bundles.



Figure 7.3
Power Computing Power 150

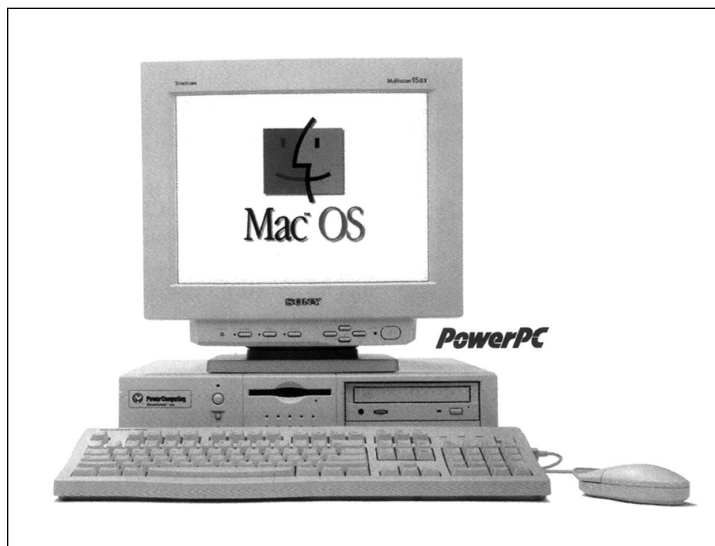

Figure 7.4
Power Computing was first to market with a Mac clone and has built in enough power and expandability to stay among the best.

DayStar's Multiprocessing Macs

DayStar is another company making innovative Macintosh clones. Together with Apple, DayStar designed a specification for building Macs with multiple microprocessors. A multiprocessor machine is like buying several Macs in one box. Software that is written to take advantage of multiple processors can be blazingly fast. Software that is not written for more than one processor works normally with the main processor. In DayStar machines, that means every application runs fast because PowerPC 604 chips are used. Multiple processors are expensive, however, so don't consider a DayStar unless you have the money to spend.



Figure 7.5

Thanks to software written for multiple processors, every application runs at top speed on DayStar's versatile but expensive machines.

Apple has been assigning licenses to clone manufacturers at a steadily increasing rate. Motorola and IBM have both signed on as Mac OS licensees. Both companies even have Apple's permission to sublicense to other manufacturers, ensuring that the Mac clone market will grow quickly. Be sure to investigate the market thoroughly before settling on a Macintosh model. There might just be a new clone out there that satisfies all of your computing needs.

Model	Processor/Speed	Maximum RAM	RAM Type	Maximum Video Bit Depth/Resolution*	Processor on separate card	Interleaved Memory	Bus Type
Apple Power Macintosh 6100/66	601 at 60 MHz	72MB	SIMM	24-bit at 832 × 624	Yes	No	7" NuBus (1)
Apple Power Macintosh 7100/80	601 at 80 MHz	136MB	SIMM	24-bit at 832 × 624	Yes	No	NuBus (3)
Apple Power Macintosh 8100/100	601 at 100 MHz	264MB	SIMM	24-bit at 832 × 624	Yes	No	NuBus (3)
Apple Power Macintosh 7200/75	601 at 75 MHz	256MB	DIMM	24-bit at 832 × 624	No	No	PCI (3)
Apple Power Macintosh 7200/90	601 at 90 MHz	256MB	DIMM	24-bit at 832 × 624	No	No	PCI (3)
Apple Power Macintosh 7500/100	601 at 100 MHz	512MB	DIMM	24-bit at 832 × 624	Optional	Yes	PCI (3)
Apple Power Macintosh 8500/120	604 at 120 MHz	512MB	DIMM	24-bit at 832 × 624	Optional	Yes	PCI (3)
Apple Power Macintosh 9500/120	604 at 120 MHz	768MB	DIMM	Optional	Optional	Yes	PCI (6)
Apple Power Macintosh 9500/132	604 at 132 MHz	768MB	DIMM	Optional	Optional	Yes	PCI (6)
Power Computing Power 80	601 at 80 MHz	200MB	SIMM	24-bit at 832 × 624	Yes	No	NuBus (3)
Power Computing Power 100	601 at 100 MHz	200MB	SIMM	24-bit at 832 × 624	Yes	No	NuBus (3)
Power Computing Power 110	601 at 110 MHz	200MB	SIMM	24-bit at 832 × 624	Yes	No	NuBus (3)
Power Computing Power 120	601 at 120 MHz	200MB	SIMM	24-bit at 832 × 624	Yes	No	NuBus (3)
Power Computing PowerCurve 120	601 at 120 MHz	256MB	DIMM	24-bit at 832 × 624	No	Yes	PCI (3)
Power Computing PowerWave 120	604 at 120 MHz	768MB	DIMM	Optional	Optional	Yes	PCI (3) or PCI (2) & NuBus (2)

continues

Model	Processor/Speed	Maximum RAM	RAM Type	Maximum Video Bit Depth/Resolution*	Processor on separate card	Interleaved Memory	Bus Type
Power Computing PowerWave 132	604 at 132 MHz	768MB	DIMM	Optional	Optional	Yes	PCI (3) or PCI (2) & NuBus (2)
Power Computing PowerWave 150	604 at 150 MHz	768MB	DIMM	Optional	Optional	Yes	PCI (3) or PCI (2) & NuBus (2)
Radius 81/110	601 at 110 MHz	264MB	SIMM	24-bit at 832 × 624	Yes	No	NuBus (3)
Radius System 100	601 at 110 MHz	264MB	SIMM	24-bit at 1600 × 1200	Yes	No	NuBus (3)
DayStar Genesis MP 480	604 at 120 MHz(4)	512MB	DIMM	24-bit at 832 × 624	Optional	Yes	PCI (3)
DayStar Genesis MP 528	604 at 132 MHz(4)	768MB	DIMM	Optional	Optional	Yes	PCI (6)
DayStar Genesis MP 600	604 at 150 MHz(4)	768MB	DIMM	Optional	Optional	Yes	PCI (6)
Apple Performa 5200 series	603 at 75 MHz	64MB	SIMM	16-bit at 640 × 480	No	No	LC slot
Apple Performa 6110 series	601 at 60 MHz	72MB	SIMM	24-bit at 832 × 624	Yes	No	7" NuBus (1)
Apple Performa 6200 series	603 at 75 MHz	64MB	SIMM	16-bit at 640 × 480	No	No	LC slot
Apple Performa 6300 series	603e at 100 MHz	64MB	SIMM	16-bit at 640 × 480	No	No	LC slot
Apple PowerBook 5300/100	603e at 100 MHz	64MB	RAM card	16 (grayscale)	No	No	PC card (2)
Apple PowerBook 5300c/100	603e at 100 MHz	64MB	RAM card	16-bit at 640 × 400	No	No	PC card (2)
Apple PowerBook 5300cs/100	603e at 100 MHz	64MB	RAM card	8-bit at 640 × 480	No	No	PC card (2)
Apple PowerBook 5300ce/117	603e at 1117 MHz	64MB	RAM card	16-bit at 800 × 600	No	No	PC card (2)

*With two megabytes of VRAM, unless otherwise noted

Additional Considerations

So what's left? You've settled on a processor, RAM capacity, hard drive size, and expandability. There are a few other considerations to take into account before choosing the perfect machine. Peripherals, for example, such as a CD-ROM drive or keyboard, often are overlooked. Built-in extras, such as AV capabilities, also are sometimes forgotten. And finally, ease of upgrading is another commonly neglected factor.

Adding Peripherals

Many people are surprised, when purchasing a Mac, to find that not all of Apple's Macs come with a keyboard. In fact, only a few models do include a keyboard. Apple deliberately does not include one so that the user can choose from Apple's range of keyboards. Companies like Power Computing, on the other hand, often do include a keyboard.

On the flip side of the peripherals coin, most Macs shipping today do include a CD-ROM drive. Is a CD-ROM drive more important than a keyboard? Probably not, but there is less distinction between CD-ROM drives than between keyboards. By making CD-ROMs standard, Macintosh manufacturers can offer faster CD drives at a lower cost. The quality of the keyboard depends on how much you want to pay. And it's not a bad idea to have a CD-ROM drive, either. More and more software products are available on CD only, including some system software.

Double-check the peripherals that are included with the machine you choose. Some machines come with a monitor, so be sure the video capabilities are adequate so as to avoid replacing it. And don't get stuck without a keyboard; there's only so much you can do with a mouse.

Built-in Features

Apple's Power Macintosh 8500 has been called the most value-packed Macintosh ever made. Included in the purchase price of an 8500 is an impressive set of "extra" features that are not available in other Macs. Extensive AV capabilities, for example, enable the 8500 to capture and output 24-bit, 30-fps video and even include a hardware video zoom. High-quality 16-bit stereo audio input and output complement the video. No video card is necessary for all but the largest monitors, because with VRAM upgraded to 4MB, the 8500 can draw 24-bit color on monitors up to 1,152 pixels by 870 pixels in size.

Don't overlook features like these. Despite the attractive price, you're still paying for all the features in a machine. If you won't use the video output, for example, consider the 7500 instead. The 7500 has video input for video conferencing or video capture, but does not include the output options of the 8500. The 7500's processor also is upgradable, so you won't be stuck with a 601. If video is not your game, the 9500 doesn't include any

video input or output. Power Computing machines come with any number of options. You choose the ones you need; Power Computing builds the machine for you.

In short, don't buy features you won't use. The money could be better spent on more RAM or a larger hard drive.

Internal Expansion

When it comes time to install more RAM, or add a video card for a second monitor, the accessibility of a machine comes into play. Depending on the Mac you choose, you might have to employ the services of a trained professional just to install an accelerator board.

At the easy end of the accessibility spectrum, the top of a Power Macintosh 7500 can be removed just by lifting the back. The inside of the computer unfolds to reveal the motherboard underneath, ready to accept whatever expansion cards you might have. Small legs even drop down to support the unfolding portions of the machine.

The Power Macintosh 8500 lies at the opposite end of the accessibility spectrum. In order to install RAM in an 8500, the machine must be disassembled completely, right down to removing the motherboard. All wires must be unplugged and cards removed, including the processor card. And after the RAM is installed, the machine must be reassembled correctly.



Figure 7.6
PowerPC 8500

If adding extras to a machine is not a common occurrence, the ease of installation won't be much of an issue. But, if you change machine configurations often, it's worth consideration.

8

Buying, Connecting, And Using Monitors

The monitor is the last bastion of an original computer technology—the vacuum tube. Monitors, unlike the rest of a computer, are large, heavy, carry extremely high voltages, and when they break, they really break. No tiny puff of smoke here; glass goes in all directions. Why isn't it electronic, solid-state, and small? Price and performance. A glass tube the size and weight of a medicine ball may not be convenient, but it's still the best way to display an image electronically.

The following sections describe a few of the details you need to consider when buying, upgrading, and using a monitor. Despite the number of monitor manufacturers (around a hundred), there are only three companies that make the actual tubes—Hitachi, Mitsubishi, and Sony. The packaging around those tubes varies widely, from highly precise digital controls to no controls at all.

If you want to know...

Go to...

What exactly is dot pitch?	155
Why purchase a secondary monitor?	153
Should I be concerned about refresh rate?	157
How can I cut screen glare?	160
How can I get the purest color out of my monitor?	167
How do I set my monitor's white point?	164
How do I set an accurate WYSIWYG display?	161

Ratings

Sony	1	2	3	4	5
Ease of Use					
Great Features					
Coolness					
\$ Value					
Overall Rating					

Graphics art has stringent needs and requirements. Colors must be exact, as must proportion, size, and contrast. LCD and gas plasma displays are light and fully solid-state, but they're too small and too expensive for real-world use. A display should have crisp, clear colors that match as nearly as possible the real world (or at least a Pantone or TruTone color swatch-book). Its refresh rate should be fast enough to be stable and easy on the eye (more on that later), and ideally it should be capable of several resolutions. None of these are cheap or easy with LCD or gas plasma.

That doesn't mean such displays are bad. If you're short on desk space or want a monitor you can drop in a briefcase, consider an LCD or gas plasma, but be prepared to pay thousands of dollars for it.

Sizing Advantages and Disadvantages

A common mistake made by computer owners is spending too much on a single display. Although a 21-inch monitor looks great on the desk, it's probably overkill and inefficient. Before you buy a single, large monitor, consider the problems of space, weight, cost, accuracy, and hardware failure. The solution to most of these problems is, "Take two, they're small." Why two? Read on.

The issues addressed in this section affect all monitors. They are just more pronounced on larger displays, which is the reason for recommending two smaller ones.

First, there's desk space, or more accurately, desk depth. A 21-inch monitor can be as deep as two and a half feet and weigh as much as 75 pounds, which means it can be hard to put one on a desk without having it sit right on the edge. The display can end up right in your face, forcing you to back up or pull the desk out into the room. That may seem minor compared to having the extra visual working room, but you still have to carry it into your office and then will, as likely as not, end up moving it. A 75-pound monitor is not an easy thing to haul around. Make sure your desk is up to the task of holding and properly positioning whatever monitor you buy.

Also, there's the obvious cost. A simple, 13-inch monitor is between \$300 and \$350. For a 17-inch, you can expect to pay from \$750 to \$800. For a 21-inch, just four more inches corner to corner, you'll pay over \$1,000 *plus* an adapter to run it in 24-bit color, pushing the price as high as \$2,000. If you want a really accurate graphics-oriented two-page display, the price can jump to \$4,000.

If you have a high-end Mac, it might already support high-resolution, 24-bit color, so the card may not be an issue. Refer to Chapter 7 on choosing a Mac system to decide how much machine you need.



Figure 8.1

A single, big monitor can be harder to handle than expected.

Finally, there are technical issues in monitor technology, such as color spread, distortion, and dot pitch. Monitors are electron guns. At the back of every tube is at least one electron gun, and, in color monitors, there are three. The larger a display is, the harder it is to keep all three color guns pointed at the same spot. To create that perfect purple in Photoshop, you might set values in red to 65535, in green to 27182 and in blue to 63524. All three guns, carefully set to those numbers, then have to hit the same pixel in the same place and at the same angle to create that color.

In the middle of the screen, it's not hard, but the farther they have to shoot and the higher the angle, the harder it is to keep the guns in line. Thus, the corners and edges of a large screen usually aren't quite right. Colors spread, making small rainbows appear and sharp edges blur. This isn't a problem in smaller monitors—the distances are smaller and the angles lower, so the colors are more accurate (or at least more consistent). The same occurs in lines. Shapes are distorted. Adjusting pincushion and

position controls helps, but an illustration's lines tend to warp and move in generally undesirable directions when they're near the edges of the screen. It's just part of doing business with a monitor, and an issue that grows with the square area of the display.

The dot pitch is the density of the individual pixels, and the more dense the better. Larger monitors tend to have a higher dot pitch and therefore a more grainy display. Alternatively, smaller monitors tend to have a lower dot pitch, and the lower the better (and more expensive). See the section titled "Pitching Dots" for specifications.

The major advertised advantage of a big display is the capability to view a whole page or two-page spread. It is, however, possible to view a full spread without a two-page monitor. Almost all graphics and DTP applications zoom in and out, from several hundred percent magnification to the full spread. Even word processors zoom in and out these days. If you're an illustrator, you're probably as interested in what's happening at a pixel level as the overall layout, so you can zoom in and out as needed. (This is less an issue for DTP and design, when seeing a full two-page spread at full size can make a difference.) A smaller display can show you the overall design and do so with more accurate colors.

A big monitor *does* mean having room for palettes. Or does it? Palettes in applications, such as Quark, Photoshop, and the palette king of them all, Painter, demand a lot of desktop space. As much as you move them, palettes are always in the way. Some you want nearby all the time, and others you need just often enough to be troublesome. A single, big monitor gives you room to open them, but what if you want to actually use that expensive space to display your work? A two-page spread covered with palettes isn't really a two-page spread.

Finally, what if, after spending all that money, the monitor fails? Maybe it's under warranty and will be back from the shop in a week. Can you go a week without working? All it takes is a single part to fail, and you'll be asking your co-workers for help.

The answer again: take two, they're small. Instead of a single 21-inch, buy a 17-inch and a 13-inch and put them side by side. This isn't to say you *shouldn't* buy the largest monitor you can, only that two smaller ones are a handful of power for less money, and they're probably more accurate. Even if money is no object and you can afford a 21-inch monitor, having a secondary one next to it can be a real boon. The following section describes the advantages therein. PCI Mac owners most likely will have to pay more for their second video card, but they also are likely to have at least 16-bit color on that second display.

NOTE

If you're short on desktop space, you might want to look into Mitsubishi's offerings. Their new chassis claims to be about 10 percent smaller than prior models.

Secondary Monitor Considerations

A second monitor is where palettes really shine. Photoshop and Painter work best with five or six palettes on hand at all times. You can set them all up on a second, smaller monitor, so that they never cover your layouts again, or need to be rearranged each time you open an application.

A secondary monitor doesn't have to meet the extreme requirements of the main one. The main might be 24-bit color. It might be absolutely accurate, and if it is, it will be tremendously expensive. So why not buy a less expensive 17-inch (instead of a 21), and then put an inexpensive 13-inch next to it? Your main monitor is lighter and more manageable, its colors and shapes are more accurate, and it has a more favorable dot pitch.

When it comes to comparing two documents or using two different applications side-by-side, a pair is unbeatable. Even on the largest single display, it's difficult to work with two files without juggling them, deciding which covers what part of another, adjusting their sizes to fit and then squinting to see small text. On two monitors, two different applications or documents each have their own space (which brings up the issue of a third monitor for the palettes).

A second monitor need only be 13 inches across and run in 8-bit color. Used graphics cards of that type are relatively easy to pick up for \$50–\$90. (PCI Macs might need more expensive solutions.) Used monitors can be found at bargain prices too—most makers sell rebuilt, fully warranted monitors at a considerable discount. It's a secondary, so it need not be pristine.

If there's a downside to a multiple-monitor setup, it's space. You use a lot more desk space horizontally, but it is useful Mac desktop space. Having a large electronic desktop makes sense—after all, a physical desk is as much as six feet across and four feet deep. Why should your electronic desk be only the size of a large pad of paper?



Figure 8.2

Two smaller monitors are more manageable and possibly more accurate.

Finally, instead of spending up to or more than \$2,000 on a single box that, if it fails, can leave you out in the cold, you can have a potent arrangement for less than \$1,500, plus a spare monitor. This is very handy when Murphy steps in the day your biggest project is due. All it takes is a single failure of a single part in your monitor to shut a whole project down...if that one monitor's the only one available.

TIP

When comparing monitors and their technologies, stick with the non-interlaced models. An interlaced display really isn't up to the task of graphic arts.

Specifications

Monitor technology might still rely on massive, glass tubes, but it is advancing, and there are considerations as to what kind of internals your monitor should have. This book won't go into the technical details other than to outline them briefly to help you make a decision. Your eyes are still the best judge. This section will help you decide just how much you need for your particular work and provide basic requirements for whatever you decide to buy. At the end of each section is a short statement on what to look for in a primary vs. secondary monitor.

Flat-Screen Monitors

Big glass picture tubes all look the same from a distance, but they come in a wide range of curvatures. Generally speaking, the flatter the tube, the more accurate its image. Also, flatter tubes tend not to reflect as much room lighting. A round, curving tube is like a fish-eye lens or, more accurately, a fish-eye mirror. With a flat tube, you won't see a reflection of a nearby lamp nearly as often as with a round one.

Flat screens aren't really flat—they're tubular. They curve from side to side but not top to bottom.

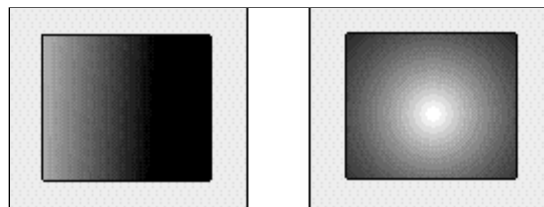

Figure 8.3

A flat screen is curved vertically like a waterglass. A standard screen is curved like a bowl.

When you're shopping, pay attention to how much the middle of the monitor bulges outward. Look for flatter rather than rounder. If you've been working with one of the heavily curved models and switch to a flat screen, it might seem as if the image is concave, pulling in at the middle. Your eye has simply learned to adjust to the curvature of the more bulbous image, and when you look at a flat screen, your eye continues to adjust. This effect disappears after a day or two, and you will find the image on-screen matches much more closely the image that comes out of the printer.

Secondary vs. Primary

In regard to your secondary monitor, curvature is an area wherein you can save money. Assuming you aren't surrounded by point-sources of light, it's possible to use a relatively curved display as a secondary.

Pitching Dots

Dot pitch is probably the most commonly quoted monitor figure. It has to do with the distance between each individual pixel on-screen. Needless to say, the closer the dots are, the more finely grained the image. The measurement is in hundredths of a millimeter, and though that might not sound like much, it does matter—the higher the dot pitch, the farther apart the pixels and the more grainy the image. Apple's 1705 model, for example, has a dot pitch of .28, whereas the 1710 has a dot pitch of .26, giving it a sharper image.

Naturally, it's not quite that simple. There are several technologies available that aren't as easily measured as a single number. Fortunately, dot pitch has come to be an industry-accepted term, so specifications usually include a dot pitch equivalency number in order to compare monitors. Those technologies are:

- Aperture grill
- Invar shadow mask
- Mask pitch (new from NEC)

The major advantage I found to the flat screen was glare reduction. The fish-eye's wide angle seemed to pick up reflections from a much wider field of view and reflected them back into my eyes. The flat screen operates the same as a flat mirror, reflecting only items at the exact angle. This made it extremely easy for me to adjust the monitor to avoid glare. When I first started to use a truly flat screen it was like looking *into* a fishbowl. Until my eyes and brain figured out to stop compensating, I definitely had the "working in a fishbowl" feeling.

Don Boylan, Schering-Plough
Help Desk

Aperture grill originated the dot pitch measurement and was the long-time standard. Aperture grill monitors do suffer from a slight instability—the aperture grill itself (a fine metal mesh inside the monitor) tends to expand and contract with heat, so manufacturers added a thin stabilizing wire. It resides on the inside of the monitor. On 15-inch and larger monitors you can see a barely noticeable horizontal line across the display, usually only when it's displaying an all-white page. Sony Trinitrons are well-known for their stabilizing wires. The wire is about two-thirds of the way down from the top of the screen and looks like a horizontal shadow inside the monitor. Seventeen-inch and larger monitors have two wires, one at one-third and another at two-thirds of the way down. They're generally not a problem and are easily ignored, but they are an unnecessary artifact.

Ratings

NEC	1	2	3	4	5
Ease of Use	████████████████████				
Great Features	████████████████████				
Coolness	████████████████				
\$ Value	████████████████████				
Overall Rating	████████████████████				

Invar removed the need for that wire and the resulting shadow, because it doesn't expand when heated. The trade-off? An Invar shadow mask might not be quite as sharp as an aperture grill. Rely on your eyes though—individual monitors vary even within the same production line. There are a lot of other variables that go into focusing an electron beam than Invar and aperture grill. See the latter sections of this chapter for information on those variables.

NEC has introduced a new technology that combines shadow-mask and aperture-grill technologies called CromaClear. It uses a “slot-mask” and began shipping in early 1996. It's still too new to say whether it's superior to prior technologies, but NEC claims very good dot-pitch equivalency in its introductory line.

The highest acceptable dot pitch for graphics is about .29 (point two nine). There are many very inexpensive (read: “cheap”) monitors with dot pitches as high as .39. Stay away from them! Using one of these is like working through a screen door with all the moires, blurry edges, and inaccuracies that implies. Your head will hurt and your eyes will strain. The lowest dot pitch on the market is around .24, but anything between .25 to .29 will work without pushing you to early visual retirement. Prices rise dramatically as dot pitches drop, so compare what you need with what you can afford.

Primary vs. Secondary Monitor

The secondary monitor need not have a dot pitch as low as .25, but be sure it's no higher than .29. Anything over .31 could be a problem, even in a secondary display. You might find that you simply won't use it, especially when it's side-by-side with a much better one.

Refreshing Images

Another often-quoted figure is refresh rate, which has to do with how many times an image is re-written by the electron guns. An on-screen image might look like a single, stable picture, but the electron guns in the monitor are sweeping back and forth phenomenally fast, controlled by a large magnet, redrawing the images thousands of times per second. The faster they sweep, the more stable the image. A slow sweep is perceptible to the human eye and can cause eye strain.

Anything under 66 MHz (megahertz) is too slow. Fluorescent lights refresh at 60 MHz, so if you're working under or near a fluorescent on a slow, 60 MHz monitor, the two may well conspire to give you an all-day headache. A good refresh rate is 70 MHz or more. More than 75 MHz might be overkill unless your eyes are very sensitive to movement, so try to view before you buy. Look at the monitor both directly and at an oblique angle when you shop. If you detect vibration, you might want to opt for a faster model, 75 MHz or more. If you're ordering by mail, be sure the company has a no-questions-asked return policy and no re-stocking fee. You'll be out the return shipping fee, but if mail order's your only access, you're at least limiting cost.

If you'd like to see the refreshing going on in your monitor, eat something crunchy while looking at it. The vibration from your teeth interferes with your eyes' perception of the refresh, and the screen appears to wiggle, shimmy, and even jump around a bit. Carrots and hard candy work best.

Primary vs. Secondary Monitor

Be sure the secondary monitor has a relatively high refresh rate, at least 70 MHz. It'll be at the edge of your vision, where human eyes are most sensitive to movement. Avoid 66 MHz and slower monitors, although you might try them out (or be sure there's a return policy). Different people are sensitive to different refresh rates, so, again, view before you buy.

I'm glad you're doing this book. I have a real love/hate relationship with my Mac (more hate than love of late), and I'll be interested to hear how it comes out.

Vanessa Warheit
Left/Right Studio

How Big is That Display?

The new 13-, 15-, 17-, or 21-inch monitor that you've just plunked down hundreds or thousands of dollars for probably isn't as big as its literature says it is. There are plenty of 13-inch monitors with images that measure only about 12 and a quarter inches and 21-inch monitors with only a little more than 19 inches of actual illuminated area. A monitor's glass tube may be a full 14 inches across, which is the number marketers advertise, but the displayed image or *raster* is generally smaller. Sometimes a lot smaller. More than likely it's an inch or so less than the number on the box. Mitsubishi's Diamond Scan 20M and 20LP series, for example, aren't 20-inch monitors, because their view area is only 18.6 inches. There are reasons for it, but it's still unclear advertising and is under investigation by the industry as of this writing. Check the monitor's documentation for the *actual* display area.

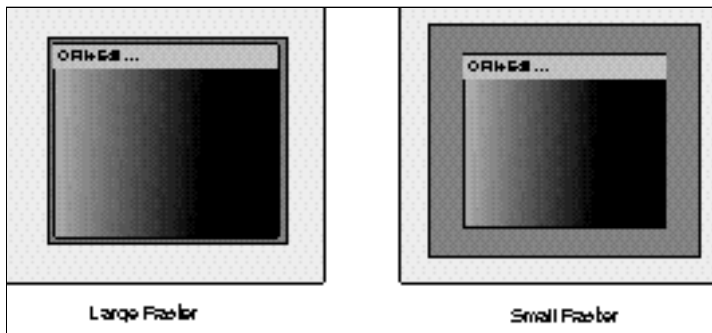

Figure 8.4

The monitor on the left has a large raster, whereas the monitor on the right has a small one.

That doesn't necessarily mean you're buying less of a monitor. A more relevant number is how many pixels it can display. A 13-inch monitor at 640×480 is displaying WYSIWYG (What You See Is What You Get). Even if there's only 12 and a quarter inches of display area, you're still getting all 640 pixels across and 480 pixels high. They're just compressed a bit. The following table describes approximately how many pixels it takes to display a WYSIWYG image on a given monitor.

Monitor size	Pixels required for WYSIWYG
13-inch	640 × 480
15-inch	640 × 480 or 832 × 624
16-inch	832 × 624
19-inch	1024 × 768
21-inch	1178 × 1026

Fifteen-inch monitors are a special case. They can display 640×480, which is slightly larger than WYSIWYG, or 832×624, which is slightly smaller than WYSIWYG. What works better is purely a matter of personal preference. Fifteen inches is really the minimum size for any real graphics work, so 832×624 is the recommended working resolution, and if you can find the funds, move up to a 17-inch.

There are reasons for a smaller raster image. First is the aforementioned color spread—the farther the electron guns have to reach, the more likely they'll miss their target, creating rainbows and blurry images. To avoid that, manufacturers reduce the gun's reach, shrinking it in toward the middle of the tube. Second, the more dense the pixels, the smoother the image appears.

Some companies put a larger tube inside the monitor casing, and intentionally don't use it. It gives them better color and image accuracy on the outside edges. Such monitors are worth looking for, regardless of what their advertised size is. Many NEC monitors, for example, appear to have a wide plastic housing. Within that housing is unused glass area, making the display area flatter and more focused.

See the section “Resolutions and PPI” for ways to make use of higher resolutions.

Primary vs. Secondary Monitor

You can save money by buying a secondary monitor or monitor/card combination with a relatively small raster and a fixed resolution of 640×480. A small raster means that the display area might have a large black area of unused space around its perimeter; however, if you have the right display card, you can use that space.

The old Toby card that originated on the Mac IICI is still available on the used market. It was designed to display only 8-bit color at 640×480, but it had a quirk. Several shareware programmers took advantage of that quirk, and the result is a card that can display up to 4000×1024 pixels. Sigurour Ageirsson, is one of those programmers, and his shareware Monitor Expander is remarkably effective. The color resolution drops to black and white when the display area is too large, but you need not set it so high. At 704×512, the black area around the border of the monitor is effectively “painted in.” This is not the same as using the monitor's controls to stretch the image out to the corner, making all the pixels larger. There are actually more pixels on-screen.

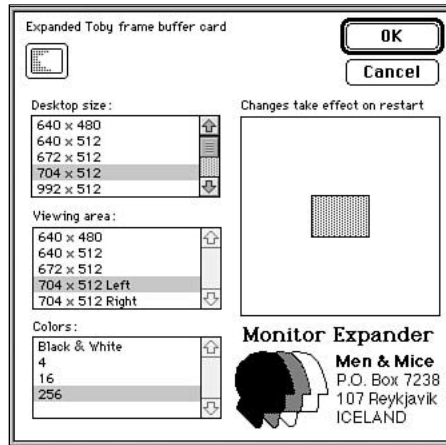
**Figure 8.5**

Monitor Expander enables you to use the unused space around a raster.

Etchings and Coatings

Etchings and coatings help ameliorate both reflections and glare. If you work in a well-lit room with lamps and lights all around, there is more than likely a reflection or a glare on your monitor's surface. It can be minor enough to ignore or bothersome enough to force you into contortions, moving your head and from side to side to, in effect, see around the glare. An etched or coated display cuts the glare by giving the display a matte finish.

Being less smooth, the surface is less reflective, which is good, but it's also less transmissive. That is, images on the monitor aren't as sharp as they would be with a non-etched or non-coated surface. If you don't do a lot of detail work, it's no problem and easily overlooked—you can use an etched or coated monitor without concern. They do have an eye-pleasing finish. For highly detailed work, however, the smoother the better. CAD/CAM operators usually work in dimly lit rooms with highly polished monitor displays that show every pixel as accurately as possible.

Another issue with etched and coated monitors is cleaning. Because the surface isn't entirely smooth, it's not a good idea to wipe it with an ordinary cloth and glass cleaner as you would a standard model. Such monitors come with specific cleaning instructions and should be handled with care. If you or your co-workers tend to put fingertips directly on the monitor and smudge or smear it, cleaning might be a never-ending problem. If you're careful, however, and don't spatter, batter, or finger your screen, cleaning isn't such an issue. Read the instructions for any coated or etched monitor before you buy it; make sure cleaning's not a chore unto itself.

That said, the high-end monitors designed for prepress work often come with etchings and coatings that are high enough quality to be free of such problems. It's a case of getting what you pay for, so in general, avoid inexpensive monitors with etchings and coatings.

Resolutions and PPI

WYSIWYG is less important in the world of illustration than in DTP and design. Illustrators need to see what's going on with colors and images at the pixel level as much as the overall design, and as such an illustrator might run a monitor at a higher resolution than WYSIWYG. A 13-inch monitor at 640×480 is WYSIWYG and displays 72 pixels per inch (PPI). At 832×624, more pixels are crammed into the same display area, reducing the jagged effect because now the monitor is at around 80 PPI. It's possible to run a few 13-inch monitors all the way up to 1024×768, creating the equivalent of a 19-inch display. There are more pixels and therefore more information on the screen.

The following screen shots are of the same desktop on a 15-inch monitor. The one on the bottom is at 640×480, and the one on the top as at 832×624. Notice that the image and desktop icons are compressed and, as a result, there's more space on the desktop as a whole.

Naturally, there's a downside. Monitors have to change their refresh rate to accommodate the higher or lower resolution, sometimes refreshing faster, often slower. As such, at 1024×768, a 13-inch, 72 MHz monitor might have to slow down to 54 MHz, and because there are so many pixels stuffed into so little area, they're likely to be fuzzy. (This is where a monitor with a lower dot pitch really shines, because the lower the dot pitch, the sharper the image.) Small, fuzzy, flickering images aren't useful, so be aware that while the resolution numbers may sound good, the images may not be. This isn't to say such displays are useless—by setting the monitor to a higher resolution, you can view a whole image at 100 percent magnification and it will all fit. Text, while tiny, is less likely to be greeked or illegible.

NOTE

Sometimes PPI is called dots per inch (DPI), but for monitors it really means pixels.

NOTE

Manufacturers are different! Check with the monitor's maker if you plan to run at higher resolutions. Some do the job remarkably well.

Troubleshooting

It is possible to set your monitor and/or card to an unsupported resolution. Not all monitors and/or cards support all resolutions and the result is a screen filled with fuzz. If this happens, just shut down the machine, unplug the monitor and let it sit for a few minutes, then plug it back in and restart. Alternatively, restart and hold down Shift-Option-P-R to reset the Parameter RAM (PRAM). Be aware that this resets a number of options; the Mac stores more than 30 settings in its PRAM, among them the date and time.

If you have a PCI Mac with a second video card, the procedure is a little different. PCI models keep those settings in the Display Preferences file in your System Folder, so the trick is deleting that preferences file. On the 7200, 7500, or 8500 series:

continues

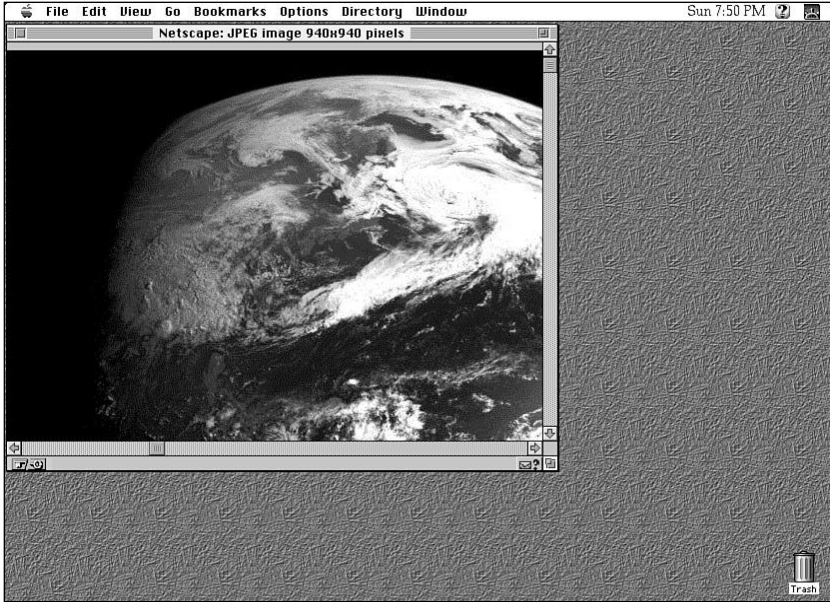

Figure 8.6
The desktop is at 832x624.

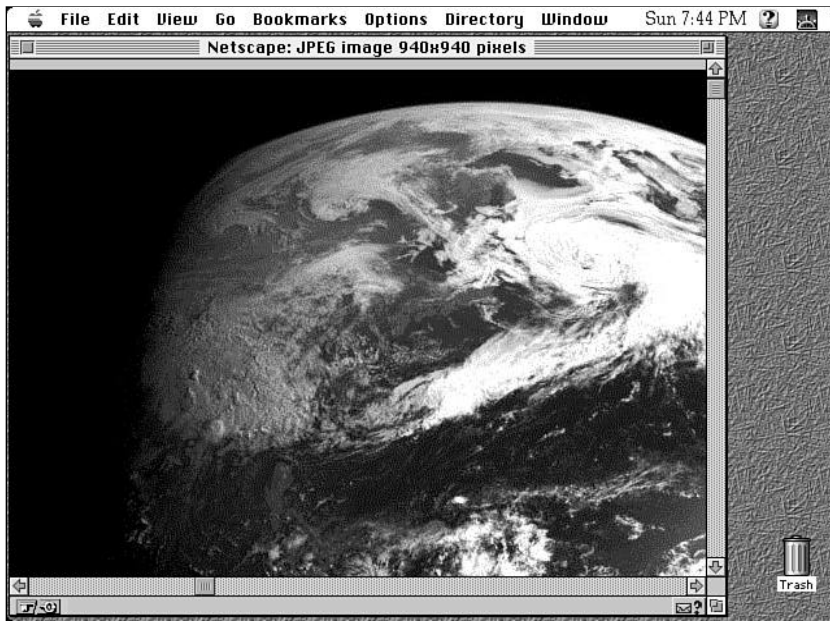

Figure 8.7
The desktop is at 640x480.

continued

- 1 Plug the monitor into the built-in graphics port.
- 2 Restart. This gives you a working display.
- 3 Locate and throw away the Display Preferences file.
- 4 Reconnect the monitor to the secondary graphics card.
- 5 Restart again, zapping the PRAM (Shift-Option-P-R) along the way.

The 9500 has its own procedure (which also works on the previous machines). The 9500 doesn't have any built-in graphics—all video is an add-in card—so you have to zap the PRAM after starting from the System Installation CD, a Disk Tools diskette, or a different System Folder. After you're up and running, locate and throw away the incorrect Display Preferences file, and then restart from your now-fixed system.

Colors and Color Depth

Obviously, the higher the color depth, the better; and rare is the graphics artist who can effectively work in less than 24-bit color. A few applications and scanners now support 30-bit and higher color. DTP professionals, on the other hand, might not need more than grayscale, just enough for editing and spot color. If your output is black-and-white, 24-bit color is an unnecessary expense. Consider your needs before you buy, because a grayscale display and/or card costs vastly less than color of the same size.

A display runs much faster, and that makes the machine feel faster, if the color depth is set lower. There aren't many circumstances when giving up 24-bit color is desirable, but if you're doing basic composition or just writing text and don't mind a little dithering in the artwork, a lower resolution is faster. Scrolling can nearly double, likewise with screen redraws.

More video RAM (VRAM) means more colors. A Centris 650, for example, with one megabyte of VRAM can display 16-bit color at 640×480 and 8-bit color at 1024×768. The same machine with only 512KB of VRAM displays only 8-bit color at 640×480 and at 1024×768 is limited to 4-bit color. For details on which machines can handle what color depths with built-in video, refer to Chapter 7, "Choosing a Macintosh Model," or call Apple at 1-800-767-2775 and ask for the Power Mac or NuBus Mac video chart. It can be faxed to you in minutes.

TIP

At one time, the limit on color resolution was upwards-only. Some machines could display only black-and-white, others only 8-bit or 16-bit, and a few went up to 24-bit. With the advent of the 7200, the limitation goes down too. 7200 and later machines cannot display 4-bit or lower color. If you've been trying to view a document in 4-bit or black-and-white on a newer machine and can't find an option for it, there isn't one.

Magnetism, Color Distortion, and Controls

The Earth itself affects monitors. Each monitor is carefully aligned at the factory so that its focus is as exact as possible, especially 19-inch and larger models. If you set yours up differently, it likely will be out of focus. If the factory focused your 21-inch monitor on a North/South orientation, for example, and yours is in the office with an East/West orientation, the Earth's magnetic field will pull it out of focus. High-end displays actually have complex color correction features just to prevent this, so look for such features if you need an absolutely accurate display. Monitors that lack such custom hardware usually have focus controls that can help ameliorate the effect. See the section "Hardware" for more information on focus.

Monitors can *powerfully* affect other monitors. Two displays are, after all, two large magnets, side-by-side. If you decide to go with two displays, be sure they're both well-shielded, because they will interfere with each other. The effect is shimmies, shakes, and color distortions, and the only fix is to put them far enough apart not to interfere, as much as several feet. That takes some of the advantage out of having two. They can even affect each other through cubicle walls. How do you know if it's well-shielded? The documentation will point it out. Most monitors larger than 17 inches are going to be fine unless they're really bargain-basement models.

You should *never* put a magnet near the surface of your monitor. It will cause color distortions, focus problems, and generally wreak havoc. Fixing it requires an industrial-strength degausser (demagnetizer). Most electronics repair shops have them and many will degauss your monitor for a nominal fee. Well-made models have built-in degaussers that automatically dispel the gradual build-up of residual magnetism that occurs in all monitors.

Controlling the Image

Every monitor has a different color gamut, a range of colors that it can display. The better the monitor, the broader and more accurate its gamut. High-end models enable you to set the white point. Ideally, you should be able to set your monitor to exactly match the output available, and it's easily done with a colorimeter. See the section "Colorimeters" for more information.

NOTE

Colors affect our eyes. Stare at a green field for a long time and when you look away you'll see its complementary color. That means the desktop pattern on your Mac affects the way you see colors, so no matter how enticing they may be, stay away from heavily saturated colors and complex patterns. Pick something neutral in light blue or gray without too much pattern. Otherwise, what looks like a perfect blue on-screen can turn out to be nearly green or red in print.

Purity is how solid a solid color can be. An impure color may fade or have off-color patches; for example, a solid blue field might have a yellow patch. It's caused by color guns that are out of alignment and usually can be fixed with the convergence controls and the degausser.

White point is the balance between red, blue, and green color guns, and it's never quite white. Various high-end monitors have different white points, but a good number to look for is D50. If you're not familiar with white point and concepts of color space, point your Web browser to <http://www.smart-pages.com/faqs/graphics/colorspace-faq/faq.html>. It's technical, but it's also comprehensive.

The white point is adjustable with Knoll Software's Gamma control panel, supplied with Adobe Photoshop. It enables you to set white and black levels, as well as the levels of red, blue, and green. It's not quite a colorimeter, but it's a remarkably powerful tool. In multiple-monitor setups, it remembers the settings for each monitor—just place the control panel on the monitor that requires adjustment. For details on setting gamma with the Gamma control panel, point your Web browser to <http://www.agtnet.com/mpca/portfolio/sch/calib2.htm>.

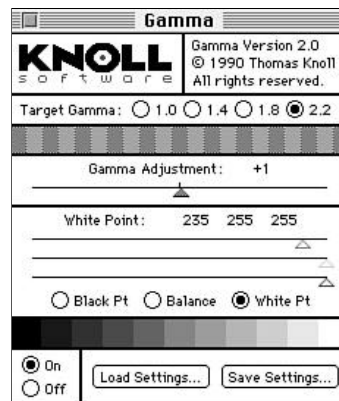

Figure 8.8

Knoll's Gamma control panel is a near-vital tool for color control.

Hardware

The first and most obvious configuration is the environment—having a monitor in the wrong lighting or at an awkward angle can really ruin the view. Keep direct sunlight or bright lighting away from the surface of the monitor. Face its surface parallel to any bright lights. If your monitor faces a window at your back, all you'll see on that monitor is a reflection of the window. A bright light can wash out the view, turning saturated colors into pastels. Facing a display toward the window means backlighting it badly. Ideally, the light in the room should be about the same brightness as the monitor. That way your eyes don't have to focus each time you look to and from it.

The Radius PressView has a built-in shade to protect it from unnecessary glare and reflections. You can build one of your own out of cardboard if the PressView's too expensive. It's a surprising improvement even in a normally lit office environment.

Ratings

Radius	1	2	3	4	5
Ease of Use	████████████████████				
Great Features	████████████████████				
Coolness	████████████████████				
\$ Value	████████████████████				
Overall Rating	████████████████████				

The following controls are available on all high-end monitors and many mid-range. The more precise your work, the more of these you should look for.

Digital settings are very handy for changing size and resolution on-the-fly. In many monitors, you can preset several settings, allowing a switch from 640×480 to 1024×768 without re-centering, re-pincushioning and otherwise re-aligning the image. A digital setting itself is not inherently better than a simple analog knob. Knobs, however, can't remember their settings.

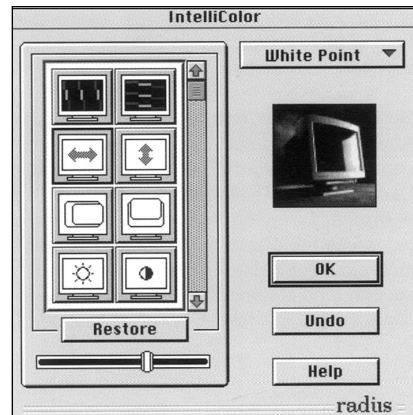

Figure 8.9

Intellicolor enables on-screen control of its monitors, rather than with knobs.

Degaussing occurs when you turn on a monitor. The monitor, before coming on, pauses, “clicks,” and then lights. That “click” is the monitor degaussing itself. Degaussing demagnetizes the monitor’s case, which gradually develops a magnetic field from exposure to the magnetic field within the monitor itself. If you see unwanted color distortions or rainbows, press the degauss button. Nine times out of ten, all will be fixed.

Convergence controls enable you to adjust the focus of the individual electron beams. Some displays allow adjustment in small segments, others adjust the entire display. Convergence is off when small rainbows or colored halos appear around on-screen objects.

Geometry settings include *pincushion*, *height*, *width*, *rotation*, and *horizontal/vertical placement*.

- Pincushioning is an effect that makes the sides of the raster image appear bent in or out, as if the image has been over-or under-inflated.
- Height and width stretch or compress the height or width of the raster image.
- Rotation has to do with the angle of the raster image on the monitor. Less expensive displays generally don't have a rotation control. An incorrectly rotated raster looks like the tube is crooked inside the casing.
- Horizontal/vertical placement adjusts the location of the raster on the display surface. You can, in effect, slide the raster from left to right and up and down so that it's properly centered on the monitor.

Zoom and Pan are available on third-party cards. Zoom enables you to zoom in and out on a particular area of the desktop to check details. Pan is a virtual desktop that runs off the edge of the visible display. When your mouse hits the edge of the screen, instead of stopping, the screen scrolls. It saves time on screen redraws. A normal scroll in Photoshop can take a lot of time because of the amount of information that must be redrawn. In a hardware pan, the image is already drawn, it's just off-screen.

Colorimeters

To get the purest possible color out of your monitor, try a colorimeter. Models that work with Apple's ColorSync are the easiest to use with system software, and some high-end monitors ship with a colorimeter. The colorimeter attaches to the surface of the monitor and reads the exact color being produced. Either it or you then adjusts the display to match a reference, making it as exact as it can possibly be. Makers include Radius, ViewSonic, Eizo/Nanao, and Colortron.

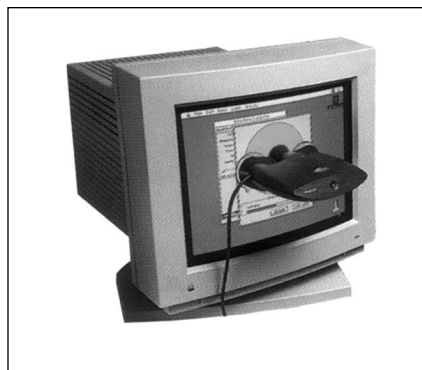

Figure 8.10

The Colortron can sense both the monitor's color and hard copy color.

Cards and Adapters

In the old days, adding a display was easy. Either you didn't because there was no option for it (as in the Mac Plus), or you went with what was available (as in the Toby card for the Mac IIci). When the 9500 was introduced, it had no internal video—you had to buy a card—and the only card available was from ATI. Life is a lot more complicated now.

Cards

Most of Apple's line-up comes with at least one video output, sometimes two. If your machine has enough RAM, you might be able to skip having a card altogether and use on-board video. See Chapter 7 on choosing a Mac to see which Macs support what color and size resolutions with internal RAM and on-board video. If you need a card, however, the PCI Macs now have several choices. Among the manufacturers are Number Nine, Matrox Graphics, Diamond, and ATI. Radius, having swallowed its competition, comes close to owning the non-PCI market.

Many cards include additional RAM, from 2 to 8 megabytes, and some are also accelerators. Investigate a model's capabilities before you buy—some are optimized for graphics, others for text, so it depends on the apps you use most. Many support resolutions up to 1600×1200, although they might not be entirely useful at that resolution. It's hard to keep electron beams focused when the pixels are crammed so tightly together.

Adapters

Now that you have a monitor and perhaps a card (not necessarily from the same manufacturer), you need to plug them together. Again, it was easy in the old days. Apple had its own video connector and its own line of monitors, but all that has changed now. PC monitors are now easily plugged right into the video-out port of many newer Macs, and quite a few of the older Macs can, with an adapter, output to PC monitors. (Thank goodness for the SVGA standard.)

Ratings

Apple	1	2	3	4	5
Ease of Use					
Great Features					
Coolness					
\$ Value					
Overall Rating					

Sony designed an adapter for its monitors that works with almost any display, Sony or otherwise. It's configured via DIP switches and fortunately includes a chart of settings on the adapter itself. The Sony MacView Adapter is available from most catalogs and many electronic superstores for well under \$30.

Griffin Technology makes a line of adapters for more diverse situations, such as BNC connectors and sync-on-green situations. Prices vary.

Troubleshooting

This book can't go into all the details of what can go wrong with a monitor, adapter, card, or combination thereof, but there are materials available from Apple. Point your Web browser to <http://til.info.apple.com/til/til.html> and do a search on "monitor." The following are a few common problems.

Shimmies and Wiggles

One of the most common problems is shimmies and wiggles. If you notice your display vibrating or waving, it might be too near a power source. Culprits include fluorescent lamps, air conditioners, space heaters, and other monitors. Anything with a 60-cycle motor, be it a vacuum cleaner or a battery charger, can and likely will affect your display. Simply move all the electrical objects you can away from the monitor. If you've moved every possible perpetrator and it's still shaking or shimmying, try moving the display itself to a different area. It could be a faulty unit. It also could be part of the room, such as a high-volume air conditioner mounted nearby or a faulty fluorescent lamp.

If moving the display away doesn't help and you've moved everything you can in your work area, it could be the power coming out of the wall. Plugging in a monitor with several other devices can affect the monitor. Plug it into a socket by itself. If that doesn't fix it, you might need a more heavily shielded monitor. Something nearby is reaching out and moving your raster.

Sync-on-Green

Another common problem is discovering that a brand-new monitor displays everything with a greenish cast. The following machines were affected by this design quirk:

- LC III
- LC 475
- LC 575
- LC 550

Performa 550/560/575/577/578

Performa 460/466/467

Performa 475/476

Quadra 605

Quadra 840AV

Quadra 660AV

Macintosh 630 family

All portable computers

Duo Dock

Duo Dock II

All Power Macintosh models

Just because your machine is on the list doesn't mean it *will* have a sync-on-green problem. Not all monitors have circuitry that gives rise to it, so be sure to ask the manufacturer if you need to adjust for sync-on-green. If you do have a machine/monitor combination that gives your display a greenish cast, Griffin makes an adapter that corrects the problem.

Monitor Manufacturers

There are almost too many monitor makers to list, but in the interest of completeness, here are a few and their phone numbers. It's not a complete list, but it is a place to start. Some come with Macintosh adapters and others require special solutions. Be sure to ask before you order. The best thing to do is find a manufacturer you trust, order documentation, and do a little research. You'll likely be intimate with this particular piece of hardware for years to come, so make sure it does what you need it to do.

Adapters and Cards

Apple	800-767-2775
ATI	905-882-2600
Colortron	800-994-2656
Diamond	800-468-5846
Matrox Graphics	800-361-1408
Number Nine	800-438-6463
Radius	800-227-2795

Monitors

Acer	800-368-2237	GVC (MaxTech)	800-289-4821
Addonics	800-787-8580	Hardware That Fits	800-364-8737
ADI	408-944-0100	Hewlett-Packard	415-857-1501
Amdek	800-722-6335	Hitachi	800-729-2233
AOC	800-343-5777	Hyundai	800-568-0060
Apple	800-767-2775	IBM	800-426-2968
Arche	800-437-1688	IDEK (Iiyama)	800-594-7480
ArtMedia	408-980-8988	Identity Systems	800-723-8258
AST	800-876-4278	Iicon	408-779-7466
Aydin Controls	215-542-7800	Ikegami	201-368-9171
Barco	404-590-7900	Image Systems	612-935-1171
CalComp	800-225-2667	Link	800-448-5465
CD Solutions	510-820-5400	MAG	800-827-3998
Compaq	800-946-9545	Magnavox	800-835-3506
Conrac	818-303-0095	Mantech	703-913-2400
Cornerstone	800-562-2552	Megagraphics	800-423-0183
Covid	602-966-2221	Megatron	714-777-6166
CTX	800-888-9052	Micro Display	800-328-9524
Cutting Edge	307-789-0582	Microvitec	404-991-2246
DEC	508-493-5111	Mirror	800-654-5294
Dell	800-289-3355	Mitac	800-756-9888
Delta Products	919-380-8883	Mitsubishi	714-220-2500
DTI	801-226-2984	Mobius	510-654-0556
Ehman	800-257-1666	Moniterm	612-935-4151
Epson	800-289-3776	Nanao	310-325-5202
ETC Computer	510-226-6250	NEC	800-632-4636
Focus	800-538-8865	Nokia	415-331-4244
Fujitsu	800-626-4686	NSA (Hitachi)	800-649-4849
Genova	310-538-4102	NutMeg	800-777-8439
Goldstar	201-816-2000	Optiquest	800-843-6784

continues

Orchestra	714-891-1386
Packard Bell	818-865-1555
Panasonic	800-7428086
PCPC	818-884-3092
PDS	619-222-7900
Philips	800-835-3506
Pixelink	508-562-4803
Portrait Display Lab	510-227-2700
Presenta	818-960-0420
Princeton Graphics	714-751-8405
Proxima	800-447-7694
Qume	800-448-5465
Radius	800-227-2795
RasterOps	800-729-2656
Relax	510-471-6112
Relisys	800-783-2333
Sampo	770-449-6220
Samsung	800-726-7864
Samtron	800-726-8766
Sceptre	800-788-2878
Seiko	201-529-5730
Sharp (LCD)	800-237-4277
Sigma Designs	510-770-0100
Silicon Graphics	415-960-1980
Smile	800-876-4532
Sony	800-352-7669
Tatung	800-829-2850
ViewSonic	800-888-8583
Wen	914-347-4100

9

Keyboards, Mice, and Peripherals

Keyboards, mice, trackpads, trackballs, and tablets; they're all ways to tell your Mac what to do. As often as not, the standard keyboard and mouse are all anyone uses—they have all the requisite keys and functions, but there are alternatives. This chapter is an overview of the standards and the alternatives and includes discussions about the following:

Communicating with Your Mac

As an artist, the keyboard is probably not your most important input tool. A little copy, a few menu selections, and that's about it. Mice, trackballs, and tablets are more suited to creating artwork. Still, it's important to have a solid, reliable keyboard, and the first section of this chapter will describe a few of your choices. This isn't a comprehensive list of choices or even manufacturers—there are far too many to cover here. Before you buy, call a few manufacturers to see what offerings may have changed or be on sale.

If you want to know...

Go to...

What kind of keyboard is right for me?	174
Who makes cordless mice?	179
Should I consider a trackball?	181
What is a programmable mouse?	180
Are trackpads difficult to use?	184
Are tablets pressure sensitive?	185

ADB, PC, and S-Video Cables

Apple keyboards and mice use the Apple Desktop Bus (ADB) connector, which is exclusively Apple's (as of this writing). PC keyboards tend to be hardwired to their cables. That is, the wire coming out of the keyboard is permanently attached. There are PC keyboards with a variety of Mac connectors though, ranging from RJ-11, which looks like a telephone cord, to ADB, as shown below.

If you have or find a PC keyboard you just can't live without, contact either of the following companies. They make converters for many otherwise PC-only keyboards.

TIP

If you should lose or damage your ADB cable, there's an easy fix. A standard S-video cable, available at almost any electronics or video store, has the same connector and wiring as an ADB. There's no need to find an Apple outlet store. Buy it, plug it in, and keep computing.

Keyboards

A variety of inexpensive third-party keyboards are available at computer superstores. If you rarely use the keyboard and aren't concerned with tactile feedback or sound, any of them probably will do. As long as the keyboard has an ADB port, you can plug it into your Mac and go. Prices are as low as \$50, and lower if they're on sale.

If you plan to use your keyboard for more than an occasional bit of copy, however, invest in a good one. Try several to find the feel and feedback you want. Some have a longer throw—that is, the key moves more up and down. Others are stiffer, softer, make a lot of noise, a little noise, and so on. The keyboard is one of the main points of interaction with your system, and a good one can make a big difference through the course of days, months, and years. The wrong keyboard, however, can damage your hands and wrists through RSIs, repetitive stress injuries.

Thanks to the studies of ergonomics and incessant competition, there are now many variations on the standard keyboard and mouse combination,

Ratings

Apple Adjustable Keyboard	1	2	3	4	5
Ease of Use					
Great Features					
Coolness					
\$ Value					
Overall Rating					

so you can skirt RSIs or just have an unusual keyboard. If you see a design you like, check with several manufacturers. They're constantly changing their offerings, so you may be able to find a deal or an even better design.

Apple Standard Keyboard

The Apple standard keyboard is the one you've all grown to know and love. It has 105 keys including 15 function keys, the standard complement. Apple keyboards traditionally have a somewhat softer feel and a quieter "click" than average, which is good if you like to type quietly but may not provide enough feedback for some.



I've worn out two or three boards in my time. As a professional writer, I'm not only hard on keyboards, I eat and drink over them. I recommend looking for a tough one, something with a lot of warranty. Did you know you can wash a keyboard? Just pull all the keys off, wipe it down, and put it back together again. (But don't forget to take a picture of a keyboard beforehand or have one around—remembering where all the keys go isn't as fun as it sounds.)

Davis Lee, Writer.

Figure 9.1

The Apple standard keyboard.

MacAlly

If you can't find a standard Apple keyboard, MacAlly makes a near-identical replica. The advantage? It may be easier to find, and as with all mechanical devices, it will have a slightly different feel. It also may be less expensive, depending on where you buy it.

Trackball Keyboards

If you prefer a trackball to a mouse, you can buy keyboards with built-in trackballs. It saves desk space by replacing the four cursor keys between the numeric keyboard and main keyboard, so there is a mild trade-off. The average trackball has two buttons and a resolution of 300 dpi, which is sufficient. (The higher the dpi resolution, the smoother the mouse, and the easier it is to use in fine-detail situations.)

Adesso's keyboard has 102 keys and a softer feel than average, similar to the standard Apple keyboard. Datadesk makes a keyboard that, thanks to a small border, is smaller than a standard keyboard, includes a trackball, and has a detachable numeric keypad. Datadesk keyboards tend to have a bit more "clack" to them resulting in louder, more tactile feedback.

Trackpad Keyboards

Trackpads leapt into the market with the advent of the PowerBook, but you can buy a keyboard with a trackpad built in. Like the trackball, the trackpad replaces the four central cursor keys, and Alps includes a wrist support as well. Overall, a trackpad probably isn't the best tool in graphics situations—it's just not accurate enough. (See "Trackpads" later in this chapter for a full description of trackpads.)

Curved and Ergonomic Keyboards

After many years of straight lines only, manufacturers are beginning to move to less severe designs, a nod to ergonomics. Like the now-discontinued Apple Adjustable keyboard, the Adesso Tru-Form keyboard breaks the keyboard into two separate areas. This enables your hands to assume a more natural position and may help ameliorate problems such as carpal tunnel syndrome and tendonitis. A built-in wrist support helps relieve pressure. Each has 106 keys (the spacebar's broken in half) with a numeric keypad and 15 function keys. Not everyone finds relief in an angled keyboard, but if you're having wrist pain, such a keyboard may be worth looking into.

The Tru-Form keyboard has an additional option of a pointing device. It's a touch-sensitive button that can help replace a mouse, similar to IBM's notebook pointing device.



Figure 9.2

The Adesso Tru-Form keyboard.

A more radical split-top design comes from Health Care keyboard. It looks rather like a half-open clockwork with all its gears and supports, but it enables you to adjust the angle and height of a three-sectioned keyboard. Two sections for the main keyboard and another for the numeric keypad. If you can't find a comfortable setting with one of these, a keyboard probably isn't for you.

Wrist pains from repetitive stress injury can be ameliorated by an angled keyboard but they can't be cured. If you've tried all the ergonomic boards and are still uncomfortable or in pain, it's a good idea to see a doctor.

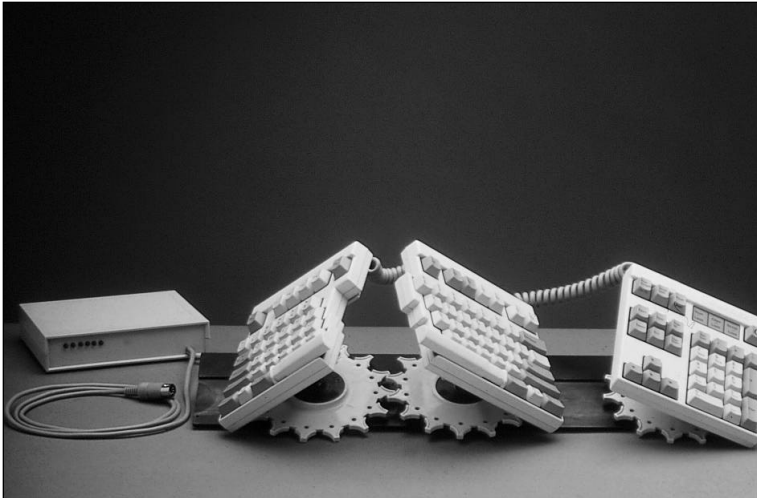

Figure 9.3
The Health Care keyboard.

Variations on Keyboards

If you're really reaching for a new way to type because of repetitive stress injuries, or if you only have use of a single hand, look into the Infogrip BAT or other alternative keyboard. Rather than typing each individual letter, the BAT detects chords of buttons, only seven of them. You can type with one hand, left or right, leaving your other hand free. There are scores of alternative keyboards on the market.



Figure 9.4
The BAT.

NOTE

For a large list of ergonomic keyboards, point your Web browser to <http://www.crl.com/~cwwcomp/macally/macally.html>. Many of them are made for PCs, but there are products to convert them to Mac; see the section on cables earlier in this chapter.

Keyboards for Fun

For the playful workstation, the artist who just won't learn to type, or for the kids, look into Kids Keys or kidBoard. Kids Keys is brightly colored and alphabetized; the keys are four times larger than standard keys, and there are only 52 of them. It may not be the most efficient keyboard, but it is an eye-catcher and it does get the job done. kidBoard is a tough plastic board that actually might be garish but is definitely a twist on the generic, platinum standard. The kidBoard is a full-size keyboard designed for children but would definitely liven up an office.



I would advise against buying software that is overburdened with features, because it can make life too complicated. I would try just working within defaults initially and maybe even strip out the things that are only very rarely, for the time being, going to be of use. It may even speed up things.

Andrew Rodger Associates -
Chartered Architects &
Interior Designers

Figure 9.5

The kidBoard keyboard.

Mice

Like the standard Apple keyboard, there's the standard Apple mouse. It has evolved a great deal since the early days of the Mac Plus, when it was putty colored and shaped like a bar of soap. The Apple mouse still is undoubtedly the most popular Mac pointing device. There are other ways to go than a single-button, standard mouse, though. There are mice without cords, mice with two, three, and four buttons, and mice that aren't really mice.

Mice that aren't mice usually are trackpads, trackballs, or pens. All have their points, and in the world of graphics, choice is a very handy thing. The following sections describe various strategies for each type of

TIP

If you're using a one-button mouse with a DOS application (via the Apple DOS-compatible card), you don't really need a second button. Just put your cursor on the object that needs a right-button click and press Shift-F10, then click.

device, plus a few hints and tips. Things to look for in a new mouse include a comfortable gripping surface, not too slippery, and an angle appropriate to your hand. Some mice may force you to reach for a button (or buttons) and may not be quite right for your hand.

Apple and Other One-Button Mice

Standard single-button mice range from \$20 for the most basic to well over one hundred dollars for multi-button programmables. If you have no need for extra accuracy or bells and whistles, you can use any single-button, ADB mouse. They come from MacAlly, Kensington (Mouse-in-a-Box™), Alps, and many other manufacturers. If you're a power user, however, there's nothing like firing off a complex macro with a single mouse click or popping up custom menus wherever you happen to be on the desktop.

Ratings

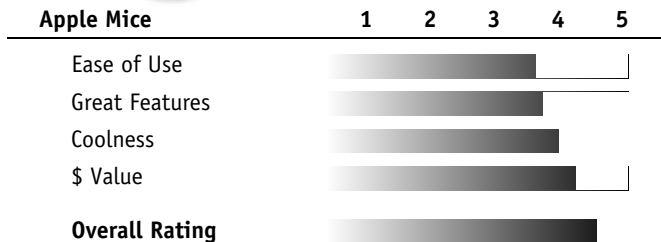

Optical Mice

For extreme accuracy, look into optical mice, like Mouse Systems' A3Mouse and Little Mouse ADB. They cost a bit more, but if you find you just don't have the hairline precision you want, an optical may fill the bill. They're perfect for CAD/CAM work. Optical mice use light and a special mousepad rather than a rolling ball to sense the mouse's location and direction.

The coated, reflective pad is tough and rigid, rather than soft. The mouse senses location via a beam of light from the mouse reflecting off the pad, so there are no moving parts to calculate the cursor's location. Most optical (and most high-end) mice include software to adjust the device's level of detail and behavior. This type of software goes well beyond Apple's Mouse control panel and varies widely between manufacturers.

Cordless Mice

The Logitech Cordless Mouseman uses radio waves to clear your desk of one cable—the mouse's. Is it effective? It depends on your desk. If your work area is covered with documents and papers and pictures and print-outs, you may bury the mouse in disarray and block the transmission from

the mouse to its receiver. The mouse also can fall on the floor and be lost, something unlikely with a corded mouse.

A cordless mouse's only real disadvantages are batteries, blockage, and price. Of course, standard mice don't need batteries, they use power from the ADB port. Cordless mice do use batteries, however, so keep a spare set of batteries around just in case (or a spare mouse). Blockage can be a problem because cordless mice require a line of sight to their receiver boxes. The mouse communicates through the air with a receiver, and that receiver may be several feet away. If you put a book or box or anything of significant size between the mouse and the receiver, the mouse stops working. Again, it's best to have a clean desk if you plan to invest in a cordless mouse.

Multi-Button Mice

A whole slew of multi-button mice are on the market, each button programmable for different functions, some even working in chords. PCs and Unix boxes have had multi-button mice for a long time, though the second and third buttons' functions vary widely, making their use more than a bit confusing from system to system.

Kensington

Kensington makes four-button mice with highly programmable buttons, enabling you to arrange the buttons' functions to your liking. These mice cost more than single-button mice, but enable you to execute a complex macro or perform a copy, paste, and insert with a single click. You also can set up "hotspots" to which the cursor automatically jumps. Very handy with a large monitor or a multi-monitor setup, where traveling to and from the menu bar or across the full display is a long trip.

The Kensington Thinking mouse is probably the most sophisticated of the multi-button mice and ships with a manual more than 60 pages long. With that complexity comes considerable power. With the included software, you can create custom pop-up menus, lock down menus, and even set up a "rest" reminder that tells you when it's time to take a break, helping prevent RSIs and mental burnout. Kensington multi-button mice have a lot of features and aren't cheap, but they do put the power under your fingertip.

Besides the four-button, there's a two-button model with few features at a lower cost, for those who don't need to run their environment from a mouse. For simplicity, you can use the Mouse-in-a-Box™, which is a low-cost, single-button model.

NOTE

This is only a short overview of mice and some of their available features. It's a good idea to contact a few manufacturers and ask for information—specifications and styles change quickly.



Figure 9.6
FPO, Kensington Thinking mouse.

Microspeed

Microspeed also makes a multi-button mouse, though it's a little different. For one, the cable's shorter, so if you're already stretching to reach the CPU, this might create problems. Also, it has a stiffer button and slightly more rolling resistance. For some, it provides more tactile feedback. It's programmable, but to a lesser degree, and as such it tends to be less expensive than the Kensington.

Logitech

Logitech has an entire line of mice, from one through three buttons. Logitech mice have a smoother surface than many mice and are very light. They also have larger buttons than the Kensington, for example. They are well-established and have a long mousing track record.

Trackballs

If you don't have much room on your desktop and have a need for fine, detail work, a trackball is definitely worth looking into. A trackball often is more accurate than a mouse and is well suited to fine detail work, particularly CAD/CAM. Trackballs have moved quickly in the graphics world, and many artists find them easier to handle than the "bar of soap" mouse.

A trackball is, in effect, a mouse on its back. Rather than move the mouse around a pad, you simply move the ball from a single position. They're fast on a big desktop because you can give the ball a spin and let the mouse fly. In a multi-monitor or large-monitor arrangement, just finding your cursor can be a chore, not to mention moving it from one side of the display to the other, so speed is important. Because trackballs don't move, their cords don't get caught on keyboards, books, papers, and so on, and they generally require less room than a mouse.

Are they comfortable? That's always a debate. Everyone has a different opinion on whether a trackball (or mouse or tablet for that matter) is comfortable or useful. If you move away from a standard mouse, try before you buy, and if you're ordering by mail, be sure there is a return policy and no restocking fee. You may swear by your trackball, or you may swear at it. Only experience will tell.

All trackballs listed here come with custom software to enable you to set up sensitivity, speed, macros, and other customizations.

Kensington

The Kensington Turbo has a relatively large ball and four programmable buttons. It has won more awards than any other Mac input device. The Kensington does require a slightly higher wrist angle than some other trackballs because of the ball's size, but it's comfortable and easy to reach all four buttons. The Kensington Turbo's design has gone through a number of changes and is mature and solid. Included is software similar to the Thinking Mouse with customizable pop-up menus and hot-spot configuration.



Figure 9.7
The Kensington Turbo.

Ratings

TurboMouse	1	2	3	4	5
Ease of Use					
Great Features					
Coolness					
\$ Value					
Overall Rating					

CH Products

PC Week and *The New York Times* both lauded the Trackball Pro, despite its rather angular design. The buttons can be a bit hard to reach for people with small hands, and you might want to use a wrist support to be sure you can stay on top of the ball, rather than leaning toward it. All its buttons are programmable to a click, a double-click, or a click-lock. It's not quite as programmable as other offerings (namely Kensington's), but if you don't need or want so much power, it's a fully functional pointing device.

Itac

The Mouse-Trak from Itac is a heavier, more solid device than the rest. It has an oversize ADB cable, a pointer made for the big-handed. As with all the trackballs, its buttons are reprogrammable, but it uses DIP switches on the bottom rather than software. This eliminates at least one piece of software from the already ballooning system folder but isn't nearly as programmable as many of the other trackballs on the market.

Microspeed MacTRAC

Microspeed uses a much gentler slope than the Itac or CH trackballs. Its two large buttons are hard to miss, though the third can be a reach. Like the rest of the trackballs, it's programmable, and you can program the keys for different functions in different applications. It's one of the narrowest of the trackballs at only four inches wide, a consideration if you're out of desk space.



Figure 9.8
The Microspeed MacTRAC.

Logitech

Logitech has a series of trackballs. Their unusual shapes speak for themselves, so if you can't find a more traditional trackball that fits, one of these may fill the bill. Logitech's Stingray won an Industrial Design Excellence Award from the Industrial Designers Society of America. Is it comfortable

and useful? It depends. The two large buttons are much easier to hit from almost any angle, but the raised ball can be, like all trackballs, a stretch. It's impossible to say whether one model is better or worse than another, given their diverse designs. Just try them to see what fits.

Trackpads

Trackpads are, thanks to their lack of moving parts, a very reliable and simple tool. Using electrical capacitance from your fingertip, they allow mouse control with very little, if any, arm motion, and they just don't have any parts to wear out. They're also remarkably small, a quarter or smaller the size of a trackball, and much smaller than a regular mousepad.

The downside of this otherwise perfect product is that they aren't easy to use. After several hours, most people are almost as proficient with a trackpad as a mouse moving objects up and down. However, horizontal control takes more practice because of the design of human fingers. So, because of the nature of the trackpad, it probably isn't the best pointing device for an artist. All trackpads rely on the same technology, so with the exception of a variety of button placements, all trackpads handle about the same.

Hagiwara Sys-Com is an exception. Its Point Pad is pressure-sensitive and ships with a stylus. You can use a fingernail rather than the stylus, and that means a greater level of control and more detailed movement. Unfortunately, if you don't maintain pressure, you can grab the wrong object or select the wrong menu item just by relaxing almost imperceptibly. None of the trackpads are particularly effective pointers for graphics artists and are discussed here mainly in the interest of complete coverage.

Alps, Cirque, MicroQue, and Touché Trackpads

Because of their technological similarity, trackpad choice really comes down to where you want buttons and which has the best software. All four pads, unlike the Apple trackpad, accept mouse clicks from the pad, as well as from buttons on the side. Those buttons are reprogrammable in all models, except the Touché. In its defense, Touché has an Edge Motion setting, which causes the cursor to keep moving when you reach the edge of the pad.

The Alps' software is the most powerful and easiest to use, and coincidentally, the Alps also is the most expensive of the four. Software on the MicroQue and Cirque appears to have come from the same company or designer and is similarly complex. That complexity, however, does allow buttons to be programmed for specific applications.

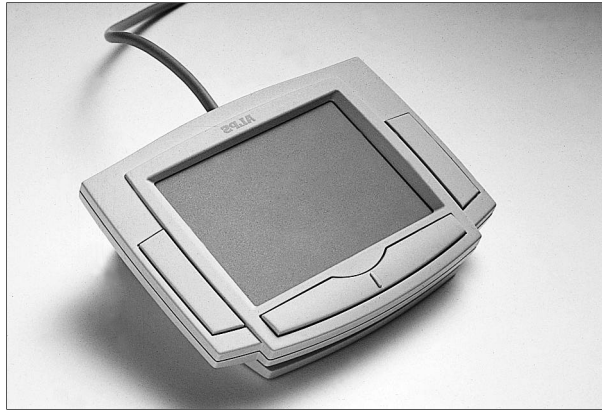

Figure 9.9
The FPO Alps GlidePoint.

Tablets

The advent of the drawing tablet brought computer graphics to a new level. Artists were able to make traditional drawings on computers. No more dialog boxes with numbers, no more drawing with a mouse, no more Bézier curves. The early tablets were little more than modified mice, drawing plain lines at preset thicknesses, but pressure sensitivity brought tablets into their own.

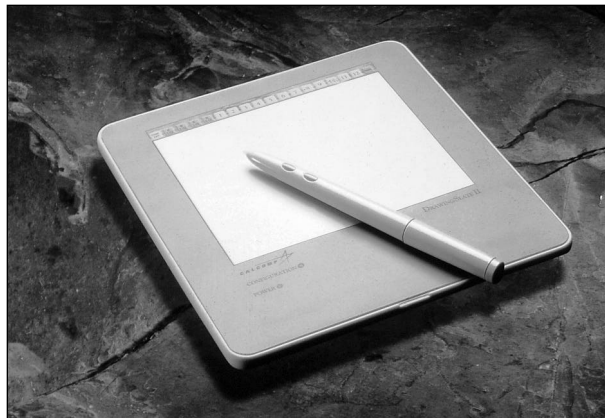

Figure 9.10
The DrawingSlate II.

Pressure sensitivity means pressing harder with the stylus draws a line thicker, darker, or more dense, just as it would with a real pen, brush, or even piece of charcoal. Traditional artists who haven't made the leap to computers can make the move without giving up basic illustration skills. Throw in an application such as Painter and a traditional artist can suddenly draw with almost any pen, pencil, or marker invented on any paper or surface, from smooth watercolor paper through rough, handmade paper. If you're an artist and you don't have a tablet, start investigating. Look at them, try them, and you'll probably buy one.

Wacom

The Wacom was the first of the cordless tablets and still is probably one of the most popular. Wacom pads have pens with neither cords nor batteries and a single button on the side. The pen is light and easy to use, though you may have to look for it from time to time because it's not tied down. As of this writing, Wacom tablets come in seven sizes, from 4×5 inches up to 18×25 inches. If you plan to do a lot of illustration, go with one of the larger versions. A smaller tablet, although less expensive, may cramp your style—a four-inch line on a small tablet draws a line from corner to corner on a 14-inch monitor.

The tablet works by emitting radio waves that are retransmitted back to the pad by the pen. Wacom offers a line of pens, with eight different designs, single and multi-button, pressure sensitivity, and a variety of feedback levels.

The ArtZ II has a plastic overlay, under which you can place drawings for reference or tracing. It also includes the UltraPen, which has a pencil-like eraser on one end. You can feather, smudge, and erase lines just as you would with a rubber eraser, and if the application you're using doesn't recognize electronic erasers (there are only a few that don't), the eraser function can be turned into a macro. The UltraPen also knows when you're drawing at an angle and alters the drawn line appropriately.

Along the top of the ArtZ II are 16 buttons that you can define to perform macros. Nine of them are preconfigured for copy, paste, and so on. Two others are preconfigured for stylus sensitivity so that you don't have to go to and from the control panel to adjust while you draw.

Wacom's smaller offering is the ArtPad. It's more suited to quick sketches and simple drawings because there's a little less room in which to work. Like all pads, the ArtPad can execute macros and shortcuts, and it includes software that lets you set its pressure sensitivity and behavior. The ArtPad's standard UltraPen lacks the angling function that allows lines to be drawn differently according to the angle of the pen. In addition, there is no plastic overlay to hold papers for tracing, nor does it have a row of macro buttons at the top. The payoff? It's about half the cost of an ArtZ II, not to mention easier to store.

NOTE

Does a tablet replace a mouse or trackball? Not really. With either mouse or trackball, you simply move your hand over and slide the mouse or ball. A tablet has a stylus that you must pick up and handle like a pen, then put down again, which is a genuine hassle after you've picked it up and put it down about one hundred times. Besides, you'll usually want to pick up the tablet, too.

Calcomp

Calcomp's approach with the DrawingSlate II is slightly different from Wacom's. The pen is cordless, but it has a battery and two buttons rather than one, making the pen heavier and thicker. Some may find this pleasant, more pen-like, while others may prefer Wacom's feather-light feel. The two buttons are small, so before buying, be sure you're comfortable both holding the pen and using the buttons.

Rather than an eraser, Calcomp offers an erase function that doesn't require you to flip the pen. That may not be quite as intuitive as a pencil, but it does save a motion or two.

As with the Wacom, Calcomp's tablet enables you to execute macros and shortcuts with the pen's buttons, and the pen is sensitive to angle. The 18 macro keys along the top of the tablet give it more than other tablets on the market, and it has a dual ADB plug, so you won't lose an ADB port if you're already short on them. It includes a plastic overlay for reference drawings and tracing, and its software is fully configurable. You can adjust its sensitivity to angle, pressure, and speed.

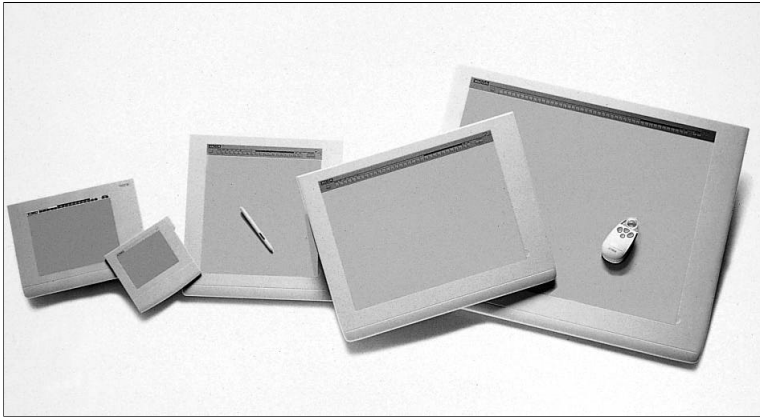

Figure 9.11
Montage of Calcomps

Hitachi StudioPad

Smaller than either the Calcomp or Wacom tablets, the Hitachi StudioPad is more of a sketch pad, perfect if you only do light illustration work or small drawings. Again, if you do a lot of illustration, spend the extra money on a larger pad. The StudioPad is cordless and pressure-sensitive, and it has a plastic overlay to hold papers for tracing.

Like the Calcomp, it uses a stylus with a battery that "sleeps" after five minutes of non-use to save power. The battery also makes the stylus slightly heavier than Wacom's and slightly larger, but it alone has a pocket clip, which is handy for keeping track of your stylus.

The Hitachi also has 15 programmable buttons along the top, useful for specific actions or executing complex macros. Neither the Calcomp nor Wacom tablets offer this, but both of them offer much larger sizes.

Software and Summation

There are many more pointing devices on the market, like the PenDirect light pen and the PenMouse, but neither is particularly suited to graphics. There is, however, software that replaces all of a Mac's input devices by operating remotely. Such software is Timbuktu Remote and Carbon Copy. Each enables you to control another Mac via modem or network as if you were sitting at that Mac, which is amazingly useful in training. A full description is beyond the scope of this chapter, but if you're trying to teach a complex graphics application, it's easier to show than tell, and you can work from the comfort and familiarity of your own machine, regardless of the keyboard, mouse, tablet, or any other devices involved.

10

Storage

Progress

Storage has come a long way from the 400KB floppy. There was a time when a System Folder, applications, and data files would all fit in such a small space, but those days are long gone. A System Folder with fonts, a few applications, such as Photoshop, Word, Quark, and PageMaker, and the files they produce require at least a gigabyte drive. If you're producing large pieces in Photoshop, you'll want at least 2GB, and that can get expensive.

Or it could've. In the last year hard drive prices have plummeted with a gigabyte internal drive reaching \$265. That's 27 cents per megabyte. Still, archiving gigabytes of data isn't cheap if you're producing several hundred megabytes each month, a problem the storage industry has solved with a whole series of removables. Because they're the latest technology and non-removable (fixed) media's rapidly become generic (buy the drive with the numbers you like), this chapter will focus on removables.

If you want to know...

Go to...

Is "burst rate" an accurate assessment of a drive's capabilities?	193
Between IDE and SCSI, which is the better cabling method?	192
What is the access time for Zip drives? SyQuest drives?	198
What is a RAID?	205
How often should I back up my data?	206
How often should I defragment my hard disk?	207
What are the advantages of tape?	196
How do I change the SCSI ID for my internal hard drive?	206
Are Magneto-Optical drives reliable?	194

Because graphics artists, illustrators, and DTP professionals usually have to move files from person to person and office to service bureau, this chapter will concentrate on the industry standards that most service bureaus support. There are a plethora of small streaming-tape drives in the under-gigabyte range, but because of their relatively small size and lack of universal acceptance, they won't be heavily covered.

How Big is Big Enough?

Nothing is big enough. No matter how much storage you buy, you'll want more, and eventually you'll have to buy more. Large network servers now hold terabytes (thousands of gigabytes) and removable media that was once limited to a floppy holding a few hundred kilobytes now comes in gigabyte sizes. The question really is, how much do you want to keep? If your work is temporal and a job completed disappears forever, a single gigabyte drive is probably enough. If, however, you're like most graphics professionals and reuse art and layouts, reference previous jobs, or want to keep lots of backups just in case, you'll want lots of removable storage.

How much is a megabyte? A byte is eight bits, or about one character in a text document. A kilobyte is a thousand bytes, a megabyte is a thousand kilobytes, and a gigabyte is a thousand megabytes. In real-world terms, a Photoshop file is usually measured in megabytes, from one or two to several hundred. Quark and PageMaker files without graphics are usually measured in kilobytes—a 200KB file.

The hard drive in your Mac is not removable storage. Fill it and you'll have to buy another. Tapes, SyQuests, Zips, and their ilk are removable. After buying the drive, you need only buy more media for it, which saves money, desk space, and SCSI addresses. Don't, however, try to use removable storage to simply increase your working area.

If a single, internal hard drive is your working area, the place where all your applications and files are stored, and you want a larger working area, then buy a larger or additional hard drive. Don't use removable media to increase your work space. Why? Let's say you're working on a large Photoshop file that's on a removable SyQuest. First, removable media is usually slower than non-removable, so you'll be waiting on the image to load and unload as you scroll around. Second, say it occurs to you that there's useful art from a previous project on another cartridge. Out comes the current cartridge, in goes the previous project's so that you can copy the art to an internal drive. Then, out comes the previous project so that you can reinsert the current project's disk. Sounds innocuous enough, doesn't it?

It doesn't take many of those swaps to become tedious, to wear out the hardware, and for you to simply lose track of what is where. It's far simpler to keep current projects on an internal (or always mounted) drive and use removables for off-line or near-line storage. (More on that in a moment.)

Issues to Consider

The following are issues to take into account in shopping for a new drive or upgrading a current solution.

- How large are your finished files? If they're only a few hundred kilobytes, you can avoid larger, more expensive solutions and go with a low-cost removable, possibly even diskettes. They're not fashionable, but they're still entirely functional and universally available. You can buy diskettes at 3:00 AM in a 24-hour convenience store. If your finished files measure megabytes, look into CD, tape, or a removable drive.
- How long do you keep your data? If you don't keep data for long, again, there's no need for massive backups. If most of your files are small (Quark or PageMaker), you might be able to get by with diskettes, but be aware that diskettes are *not* permanent storage. They have an average half-life of two years, manufacturers' claims notwithstanding. If you keep your data for a long time, CD-ROM and Magneto-Optical (MO) technology do the job. They're good for decades. Tapes also have multi-year life spans.
- Where does your data have to go? If you send files to a particular service bureau, company, or client, find out their favorite storage method. If they back up to a DAT or DLT tape and you occasionally have to send gigabyte or larger files, consider buying a DAT or DLT drive. If they use a less popular solution like the LaCie Joule removable, be sure you'll have that same bureau, company, or client for a while.
- It's always a good idea to have an off-site backup, a copy of your data stored somewhere far away so that fire, tornado, or vandals can't damage it. Hardware can be bought. Artwork, mailing lists, contracts, and client information aren't so easily replaced. Taking a drive, tape, or cartridge home also keeps data safe from prying eyes.
- What is your data used for? If it is used in presentations, CD-ROM is the distribution method of choice. There are millions of CD drives in the world today, and they all work the same way. If your data is simply pulled from one media and put onto another, how fast does the process have to be? Tape isn't a speedy medium, but it's cheap. Removable drives are about as fast as a standard hard drive, but cartridges can cost up to five times as much.

NOTE

If sending media by mail or courier to a service bureau isn't feasible, look into ISDN connections. It frees you from having to send potentially expensive and volatile media through the mail.

- How often do you need the data? Data that you don't need again any time soon can be kept off-line; that is, you'll have to jump through a hoop or two to get to it. Tape is an example of off-line storage. To retrieve a file on tape, you'll have to start the drive, find the right tape, and go through backup software like Retrospect. In contrast, online storage is immediately available. An internal hard drive is online storage, and if you need access to all of your data immediately or very quickly, consider either a very large hard drive or a removable hard drive.

The Technology

Almost all storage devices work by writing ones and zeroes to magnetic or optical media. The media spins or slides by a read/write head, and that head reads and writes as it skims the surface of the media. It's a physical process, and that means it occasionally breaks. As a matter of fact, every drive is guaranteed to break eventually, but it takes hundreds of thousands of hours to wear down a good hard drive or tape backup. More than likely you'll upgrade to newer, larger, faster equipment before anything has a chance to fail.

The exception to the physical rule is the RAM drive, which uses solid-state electronics to store data at near the speed of light. There are no moving parts, so a RAM drive never wears out, and RAM drives are extraordinarily fast. Whereas a good hard drive has an access time of eight or nine milliseconds, a RAM drive does the same thing in around 100 microseconds. (There are one thousand microseconds in one millisecond.) A good hard drive has an access time of four or five megabytes per second while a RAM drive easily handles between 10 and 16MB per second. It's possible to buy a RAM drive just like a hard drive and up to a gigabyte volume, but this is a choice for those with a deep pocketbook. (Quantum, among other companies, makes RAM drives.) The Mac's internal RAM drive is just as fast and if you have the RAM, is a good place to put a Photoshop scratch disk.

Cabling

Until recently, the only connection technology for Macs was SCSI (Small Computer Systems Interface). Apple recently adopted SCSI-2, a faster version of SCSI, and SCSI-3, a Fast Wide solution. Even more recent is the IDE standard, a crossover from the PC world. IDE drives are generally a little less expensive and a little slower than SCSI. SCSI-2 drives are suited to

What is SyQuest?

A dinosaur that eats data.

Unfortunately, SyQuest is one of the formats you HAVE to have if you deal with other people. SyQuest technology has not been reliably stable for me. I'm on my second SyQuest drive only because I need one for my work. I only use it a couple of times a year when I'm sent data on that format or when I have to send data to someone who has nothing else. Last time I used it, the data went to Hong Kong.

SyQuest—Hard to use. Why bother?

Brian Sooy
Brian Sooy & Co,

high-demand, high-speed situations, such as digital video and prepress, and SCSI-3 is even faster. Big Photoshop files that are written out to disk need to be written to fast disks, so if you're a Photoshop user and have the money to burn, look into SCSI-2 or 3. Note that not all Macs support this standard without an additional card, and not all Macs are fast enough to use that extra speed.

SCSI-2 and 3 come in two flavors, Fast and Wide. To use both you'll need a card as well as a PCI Mac. It is fast—up to 20MB per second burst rate for SCSI-2. SCSI-3 has burst rates of up to 40MB per second.

Access and Transfer Rates

Manufacturers often quote numbers like “40MB per second burst rate,” but these numbers rarely reflect the real world. As a matter of fact, they're little more than pie in the sky, ideal situations carefully crafted to make the machine look good. A more reliable number (and the one used henceforth in this chapter) is sustained transfer rate. It's more important to know how fast a drive can seek, find, and transfer data through the course of several operations than in a burst, which is exactly what it says—a single burst of data in ideal circumstances. Look for transfer rates of at least 4MB per second.

Seek times are an average of how long it takes the read/write head to locate data on the drive. It is related to how fast the drive spins as well as how fast the head can bounce around over the surface. Look for access times no higher than 10 or 12 milliseconds in internal hard drives. In compact discs, even a quadruple speed drive is around 300 milliseconds, so don't expect high rates in removable media.

The following section is a brief overview of each of the media standards. Beyond diskettes, there are three basic storage technologies:

- Winchester-style hard drive
- Optical hard drive (CD and MO)
- Tape

Winchester

Winchester is the most familiar and is the standard drive in every computer. There are both removable and non-removable Winchester-style drives, and they're so common that this chapter won't even cover drives less than a gigabyte in size. Just call your favorite manufacturer and ask for the specifications you need—they change quickly with new technologies and competition. The Appendix contains a contact list. Minimums for serious use are access rates of around 10ms and transfer rates of more than 3MB per second. Anything slower than that and you'll be waiting too long for your drive to load data.

Drives automatically park themselves. In days gone by (and on a few very old drives still in use), the read/write head had to be “parked” manually before it was safe to pick up or move the drive. This removed the head from the main surface of the platter so that it wouldn’t crash into the platter. All modern models do this as soon as you shut down.



Figure 10.1
Winchester drive.

Data is stored on the disk as a series of ones and zeroes, and the drive’s read/write head literally flies over the spinning disk. It’s only microns above the surface and is held in place by the force of air spinning by. In earlier days of computing, a “crash” was just that—the read/write head collided with the platter’s surface and could damage both beyond repair. That’s not such a problem anymore. Disks are hardened to withstand the impact of a read/write head, and the heads themselves are just as tough. That doesn’t mean you can start tossing drives around the office, but they are more resilient than they used to be.

The latest technology is called PRML, Partial Response Maximum Likelihood. It has made larger drives less expensive and can maintain higher constant transfer rates. That’s a good thing when Photoshop is reading or writing to a 30MB scratch file on disk. Compare prices between PRML and non-PRML drives and the value is quickly apparent.

Optical Hard Drive (CD-R and MO)

CD-R (the “R” stands for recordable) and magneto-optical drives are optical storage devices. In each, a laser or magnetic pulse changes a bit on the disc’s surface to one or zero as the disc spins by, albeit at a somewhat slower rate than a Winchester-style drive. CD and CD-R now come in a number of speeds, from single-speed (175KB per second transfer rate) up to

quadruple speed (615KB per second transfer rate). Even a quadruple-speed drive is slower than a hard drive but faster than they used to be at single speed.

In a standard CD-R, writing is permanent, thus they used to be called WORM drives for write once, read many. But a CD, which holds about 650MB of data, can be played in any computer CD player and the media itself is remarkably inexpensive. A 650MB blank CD is only about 10 dollars. New PD drives enable both mastering (writing) their own proprietary format as well as reading standard CDs. Unfortunately, CD-R is generally not the best Finder-style storage due to clumsy software; although new drivers by Retrospect and Optima might change that.

CD-R isn't quite a standard. Philips and Sony created a series of standards called The Color Book Specifications, which include Red, Yellow, Green, Orange, and White Books. Computer CD-Rs need only comply with the Yellow Book, a subset of which is used for the High Sierra format. The High Sierra format is what enables CDs from diverse manufacturers and recorders to work in any CD player. Some CD-Rs comply with other standards and have wider use. The White Book, for example, defines video standards. Be sure the CD-R you purchase meets but does not exceed your requirements—extra specifications are expensive.



Figure 10.2
The CD-ROM is now in many systems.

Magneto-optical technologies are more easily rewritable and come in sizes from 230MB up to four or five gigabytes per cartridge. The lower end of the scale are truly inexpensive and can compete with removables, such as the Zip and EZ135. Many MO drives, however, must make two passes to write to a disc, doubling the time it takes to write data, so while shopping, look for single-pass technology. The big CD-R/MO advantage is in archiving—both CD and MO discs last for decades, and they're relatively inexpensive compared with other removable media in their size ranges. (In the multi-gigabyte range, MO is the only removable game in town.)

Tape

Tape technology means removable technology, be it DAT (digital-audio tape), DLT (digital-linear tape) or simple streaming tape. DAT drives have a read-write head that slides along the surface of the media. DLT is slightly different in that the head doesn't touch the tape surface. It rides along just above it like a Winchester drive. DLT is also like a hard drive in that it's a lot faster than the average tape.

Tape technology also means going through backup software, because tapes don't mount like hard drives. This can be a chore. Retrieving a single file via Retrospect takes seven mouse-click selections, and then waiting for the drive to actually find and restore the file, as long as ten minutes. Hardly a quick "click and drag." Optima's Desktape, however, turns a tape into a gigabyte mountable volume that shows up in the Finder, a volume that's best suited to "near-line" storage. The data is not as accessible as with a regular drive, because tapes are still slow. The advantage? A multi-gigabyte DAT tape costs about \$10 and should last for years. (Mounting a \$10 gigabyte volume is a pleasure, even if it takes several minutes to retrieve a file.)

Removable Storage Solutions

The following sections describe several of the market's storage offerings, starting with the smallest and least expensive and work up to RAID's (redundant array of inexpensive disks). Note that for media, there's almost always a discount for buying in bulk, and "bulk" may only mean four units instead of one.

Diskettes

Diskettes, despite their fall from fashion, are still a perfectly viable media. They're universally available and applicable—anyone but a few Duo users can use diskettes to move and store data. Diskettes don't travel well by mail, but in a pinch, a well-packaged diskette or set of diskettes is cheap, fast distribution or backup. If you plan to store data on diskette, be sure to make at least two copies. They are prone to failure.

Ratings

Compact Pro	1	2	3	4	5
Ease of Use					
Great Features					
Coolness					
\$ Value					
Overall Rating					

Their downside is, of course, size and stability. The largest Mac diskette only holds 1.44 megabytes, which isn't a patch on a functional Photoshop file. Note that Photoshop and graphics files can compress tremendously. A two or three megabyte TIFF can easily be squashed with StuffIt or Compact Pro to fit on a diskette. Compression adds to the time it takes to store and retrieve the file, and if a compressed file becomes damaged, it's considerably harder to restore, but compression is cheaper than media.

Ratings



Ratings

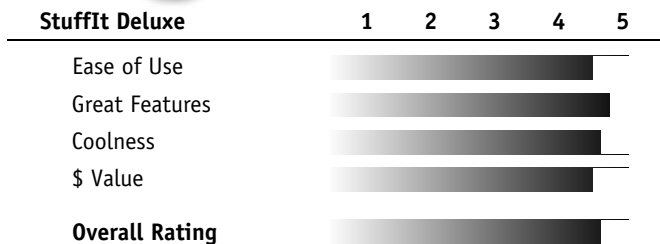

Smaller Removables

Omega's Zip and SyQuest's EZ135 and 105 are similar in size, but the Zip uses technology similar to a diskette, whereas the EZ135 and 105 use Winchester hard drive technology. SyQuest's 105 and 270 replaced the still-ubiquitous 44MB and 88MB cartridges. The LaCie Joule is a traditional removable hard drive, as fast and large as an internal hard drive.

Iomega Zip

The Zip drive is the belle of the ball right now, its popularity nearly drowning it at birth. So many wanted to buy Zip drives that they weren't available to many users until recently. Now that the backlog is filled, you can buy

Iomega Zip—A superb storage device which has saved my butt more than once. It has become the transport medium of choice with the printers I use. My biggest complaint...it is a bit slow in loading info, and I have often watched as it goes into sleep mode while the system read a file I was transferring then.

100MB of storage, expandable in 100MB increments with additional disks, for around \$200. Practically every service bureau in the nation has a Zip drive now.

Iomega Zip—I looked into a cartridge and saw a floppy. I don't trust floppies. I want a metal disk.

Ratings

Iomega Zip	1	2	3	4	5
Ease of Use	████████████████████				
Great Features	██████████████████				
Coolness	██████████████████				
\$ Value	██████████████				
Overall Rating	██████████████████				

The drive itself weighs less than a pound, so it's easily portable, and it has no power switch, thus keeping hardware to a minimum. Plug it in and it's on. (Note that the Zip drive can only be at SCSI ID five or six.) There is, however, a large power supply "brick" that weighs several pounds. Zips are about as fast as 44MB and 88MB SyQuest drives, which are, in turn, about as fast as the slower hard drives on the market. Along with basic utility software, it includes VirtualDisk, a cataloging tool that tracks which files are on which disks. Access time is about 30ms and transfer rate is about 1.5MB per second.

Iomega Zip should be included in every Mac. Who needs 3.5" disks anymore anyway? Wish more service bureaus took them.



Figure 10.3
Iomega Zip Drive.

SyQuest

At about the same price and size is SyQuest's EZ135. Although SyQuest has had some trouble making the drive profitable, it does hold 35MB more than a Zip for about \$30 more. Like all SyQuest media, removing a cartridge from the drive requires ejecting the icon, pushing the release button, waiting for the drive to spin down, and then sliding the eject switch to the side. (The Zip simply ejects when you drag the icon to the trash.) The EZ135 is about twice as fast as a Zip and can be set to any valid SCSI ID number. It ships with a collection of tools and even a few toys like Marathon and applications like Alchemy. Access time is about 13.5ms and transfer rate is about 2.2MB per second.

SyQuest Service bureaus use them. That's the biggest reason for having one. Thinking of getting one new? Forget it. Get a Zip and then just tote it with you if the service bureau doesn't have a drive. The drives are overpriced, and the cartridges are overpriced and not as reliable. I've seen several SyQuest carts go bad...never seen a Zip disk go bad (yet).

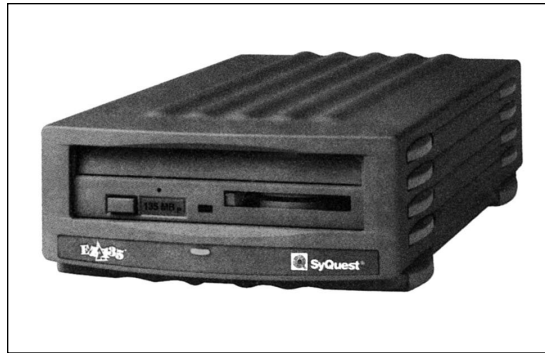

Figure 10.4

The SyQuest EZ has the fastest access time in its class.

Ratings

SyQuest	1	2	3	4	5
Ease of Use	[Progress bar to 4.5]				
Great Features	[Progress bar to 3.5]				
Coolness	[Progress bar to 3.5]				
\$ Value	[Progress bar to 3.5]				
Overall Rating	[Progress bar to 3.5]				

The 105 and 270MB SyQuests are older, but basically the same device in different sizes. The 135, 270, and 105 all use the same style cartridge, but they aren't compatible with each other. As their names imply, they hold 105 and 270MB, respectively, and at near hard-drive speeds, are faster than the EZ135. The 105/270 follows SyQuest's previous lock on the removable market with its still ubiquitous 44 and 88MB cartridges. Relatively large and clumsy, 44s and 88s are still a standard around the world, only recently being replaced by the likes of the Zip.

SyQuest A great storage device. Very slow in writing information. Quality control is not up to par...I've had to return one out of five carts because they were faulty and wouldn't format. Carts are too expensive for what you get. I would rather they come pre-formatted rather than having to sit there and format each new cart.



Figure 10.5
105 and 270MB SyQuests.

LaCie Joule

The LaCie Q series are removable and range from 545MB through 4GB. Seek times respectively range from 14ms to 8.6ms. The Joule series has a "Smart Dock;" rather than pull a cartridge out as with most removables, the entire sealed drive docks to a small power unit with cabling built in. It comes in sizes ranging from 545MB up to 2GB.

Magneto-Optical

Once the realm of the serious archivist only, MO drives in 230MB range are now thoroughly affordable. (Multi-gigabyte MOs, however, are still several thousand dollars.) There are scores of resellers for MO enclosures, most of which are based on one of just a few internal drives. They include, Nikon, Pinnacle, Sony, Mass Optical, Olympus, and MOST (Mass Optical Storage Technology). None of the MO drives are particularly fast with access times around 40ms and transfer rates of 2.1MB per second, but that's the story of MO. Call your favorite drive manufacturer, ask if they carry a 230MB MO and ask for specifications.

MOST made the first 3.5-inch, 128MB MO drives as well as the first rewritables of that size. They're among the makers moving to a single-pass write technology, which cuts the time it takes to record data. It's called LIM-DOW and is worth looking for. Ocean Systems has a 5.25-inch MO drive that holds up to 2.6GB on a disc, twice the standard 1.3GB size of such devices.



Figure 10.6
Magneto-Optical Drive.

CD-Recordable

Despite awkward software, the CD-R is hard to beat, \$10 for blank media that holds 650MB and works on so many different machines. Again, many resellers have CD-R drives, among them Panasonic, Plasmon, LaCie, and Toray. CD access times range from 300 to 175ms (single and quadruple-speed, respectively). Transfer rates go up to around 5MB per second. The numbers vary with manufacturers and drivers.

Philips Electronics' CDD2000 records at double speed and reads at quadruple speed, and Microboards' PlayWrite 2000 and 4000 run at double and quadruple speeds, respectively. All come with one or two blank discs.

Panasonic's PowerDrive² is both a PD drive and a standard CD reader. It is expensive as CD players go, relatively inexpensive as CD-R devices go, but it uses a different technology from standard CD-R. As such, it can't write to standard CD-R discs. The PD uses its own rewriteable media, which is about \$60 for a 650MB disc. Rather than a SCSI ID button it uses DIP switches, but it does include RCA jacks for sound output.

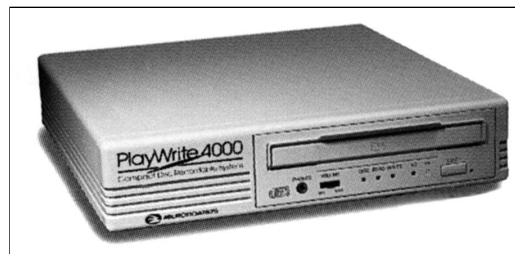

Figure 10.7
Microboards PlayWrite 4000fc.

Plasmon also makes a PD drive that reads at quadruple speed and writes proprietary 650MB PDs. The RCD 5040 from Pinnacle Micro writes at double speed, reads at quadruple speed, and includes RCA audio jacks. Yamaha's CD-R does the same but ships without the usual authoring software, which, for graphics artists, is a blessing in disguise.



Figure 10.8
Pinnacle RCD 5040.

Jaz and SyJet

Moving up from hundred-megabyte storage to gigabyte removable there are the Iomega Jaz and SyJet drives. A single cartridge holds a gigabyte of data, making it perfect for those who need fast access to big files.

Iomega Jaz

The Jaz is considerably faster than its smaller brethren, the Zip, thanks not only to faster hardware but a SCSI-2 connection. The Jaz weighs less than two pounds and can be purchased in arrays of several disks. While it doesn't eject quite as quickly as the Zip, the Jaz doesn't require the SyJet's button-push/lever-slide maneuver. It has but a single eject button that's enabled several seconds after the icon has been dragged to the Trash. It's also bundled with disk-cataloging software and basic utility tools. Its access time is 17.5ms and transfer rate is 10MB per second.

Iomega Zip. Still some problems with my SCSI-chain, though I don't know that it's the Zip's fault. Besides, since I own stock in the company (and it has increased sevenfold in value in less than a year) I encourage everyone to buy one!

NOTE

The Lido7 driver that ships with the drive isn't necessarily bad, but FWB's HDT Toolkit is more powerful and, as of this writing, handles disk ejection more elegantly.



Figure 10.9
Jaz Drive from Iomega.

SyQuest SyJet

A model that's been slow in hitting the streets, the SyJet holds up to 1.3GB. It has an access time of 11ms and a transfer speed of 4MB per second, making it faster than the Jaz. The SyJet has one of the lowest costs per megabyte at around seven cents, but finding one for sale wasn't easy as of this writing.

SyQuest—I hate it, but I use it all the time. The cartridges are too large, too fragile, and cost a fortune. I've also had a lot of reliability problems. It's just about at the point where you could get along without one.

DAT, DLT, and 8mm

One of the least expensive storage options is tape. There are dozens of smaller streaming-tape models on the market, but the three that carry the biggest load are DAT (digital-audio tape), DLT (digital-linear tape), and 8mm. A number of companies have their own models with a variety of features and prices, but the mechanisms are all similar. The hassle of tape is that it's generally not a mountable volume. One has to go through backup software, such as Retrospect, to get to the data, and tape is slow.

DAT Tape

A DAT tape is small, half the size of a standard audio tape and only 4mm wide. That tiny package can hold well over a gigabyte for ten or twelve dollars. DDS2 drives hold as much as 5GB with compression. If a DAT tape has a drawback, it's speed. Utilities, such as Optima's Deskape can make it into a mountable volume, which makes using a tape far more tolerable. Because of their small size and low cost, many companies use them for network backups. If you occasionally send large files to a service bureau, consider using a DAT as your backup method of choice. It's easier to send a single DAT than ten segmented Zips.

DLT Tape

DLT crossed over from the Unix world only recently and is one seriously fast backup device. It has a transfer rate of up to 2.5MB per second (fast for tape) and capacities up to 40GB with compression. Making use of this speed and space means having a fast machine though—DLT relies on speed to cram as much data as possible onto a tape, so a slow machine will put less data on a tape than a fast one. Unless you're on a high-speed network or have at least a PCI Mac, the DLT's real power will likely go unused.



Figure 10.10
DLT (digital-linear tape).

8mm Tape

Eight millimeter tape has been around for a while, and almost all the drives themselves are made by Exabyte. As usual, many resellers have their own models with varying cases and options. An 8mm drive has an odd advantage—if you happen to own an 8mm video camera, you can use the same tapes in your camera as your backup. (Note that backup data is not very interesting viewing, and using videotape as storage is not a good idea. Use data-rated tapes or risk losing your data.) Storing up to 14GB per tape (with compression) and recording at around 500KB per second, 8mm is on par with DAT speed but holds more data. Tapes are also a little more expensive and a little larger, about the same size as an audio cassette.

Fixed Storage Solutions

There are many companies making internal and external drives that range from 80MB through several gigabytes, and most buy the actual drive from one of only a few manufacturers. The electronics around the platter, the casing, and the drivers are where they differentiate themselves. After reaching the gigabyte range, it's hard to go wrong—almost all have access times of 9ms or less and most are based on a few mechanisms. Use the list

in the Appendix to call a few manufacturers and compare their latest numbers. One drive that's recently been doing well is the Quantum Fireball series. Many manufacturers base their offerings on it.

One oft-overlooked fact in hard drives is noise. Choosing a removable drive is generally based on need alone, but fixed hard drives are rapidly becoming generic. Why buy one over another? A single, internal hard drive isn't loud enough to be an issue, but two of them can develop unusual and irritating harmonics. More than one unhappy user has returned a drive because the noise was slowly but surely drilling a virtual hole in his or her head. After comparing prices, warranties, and sizes, ask about decibel levels. The Quantum Atlas is one of the quietest, and companies like PLI, APS, and Mirror base their multi-gigabyte drives on it.

RAIDs

A RAID is a "redundant array of inexpensive drives." RAID's are useful when data has to move extraordinarily fast, as in digital video, or when redundancy is vital. A crash with a mirrored drive means one copy of the data is gone but the other is fine. There are three basic categories of RAID: stripe, span, and mirror. Within them are variations, but for graphics purposes, these three are the most relevant.

When two drives are striped, their data is mixed. Track 1 is on Drive A, track 2 is on Drive B, track 3 is back on Drive 1, and so on. The two drives function as a single, larger device. It's faster because one drive can read while the other writes, or both can read or write and send the data to RAM, which is much faster than a drive.

Spanned drives are similar to striped drives, but simpler. In a spanned drive, several drives show up on the desktop as a single, large device. There's no effort made to read or write as efficiently as a striped drive.

Mirroring makes two drives exactly mirror each other. Data is written twice, once to each drive, which can slow the process a bit. There are mixes of striping and mirroring to increase speed, but that's beyond the scope of this book. The following paragraphs cover a small sample of the RAID drives on the market today.

A PCI solution, ProMax makes fast and wide SCSI-2 arrays that ship with Adaptec's PowerDomain 2940W PCI card as well as RAID software from Trillium Research. As of this writing, the ProMax drives come in 4 through 16GB sizes and, with a striped array, can maintain about 13MB per second throughput. Adaptec makes PCI cards that support not only fast and wide SCSI but the new Ultra SCSI, which has a burst rate of up to 40MB per second.

Similar to the previously-mentioned LaCie Joule system, LaCie's Joule RAID is a stack of drives in docks, all with a single cable rather than a mass of cables. Systems come in sizes ranging from 4 through 17GB.

Removables like the Jaz are now coming out in RAID formats with as many as four cartridges loaded simultaneously. If one cartridge fails, it's easy to replace it and keep computing. Building a single, large drive is as easy as adding and formatting more cartridges.

Backup Strategies

Backing up isn't as simple as putting everything on a drive or tape and leaving it. Backing up incorrectly or inefficiently can cost time and money, so here's a quick backup strategy to get you started. Modify it to fit your needs and schedule.

Create or buy room to make seven full backups. For convenience, we'll use tapes in this description. Stack five tapes next to the drive. At the end of each day, pull the tape off the bottom of the stack and do a backup of at least your working files. When that's complete, put that tape on top. Do this each evening, one tape for each business day.

At the end of the week, do a full backup that includes the System Folder and applications. Put that tape aside and use it again next week, but don't use it until next week. This way you can retrieve files that might have been overwritten over the course of the week. Do the same thing with another tape at the end of the month, using it only once each month. Most important, take the weekly and monthly tapes home or move them off-site. That way, should there be a disaster, you'll only lose a few days of work.

Technical Tips

For those who'd like to delve a little further, here are a few technical tips.

Setting Internal SCSI IDs

Using a PowerBook as a SCSI device is not without hazards. There are two cables required, one that mounts external drives on the PowerBook, and another to make the PowerBook mount to another Mac as an external drive. (APS makes an adapter that switches between the two modes.) Accidentally plugging the PowerBook in as a PowerBook instead of an external device means two hard drives at SCSI ID 0, which can trash one or both disks. It causes catalog errors, which often makes at least one Mac think that its drive needs to be reinitialized.

A simple fix is to change the desktop machine's internal SCSI ID. Make a note that it's been done so you won't set another device to that number, and you can keep PowerBooks and desktop Macs from eating each other's disks. Internal drives generally don't have SCSI ID push-button switches. They have *jumper*s, pairs of metal pins that, when a "jumper" is placed across them, changes the ID number.

Open the Mac and locate the internal hard drive. On the hard drive, look for circuits marked A0, A1, and A2. There's usually a jumper on one pin but not connected to any other, not jumping. The following table shows which pins you must set the jumper on to set the SCSI ID.

SCSI ID	Jumper
0	No pins jumped
1	Jumper across A0
2	Jumper across A1
3	Jumpers across A0 and A1
4	Jumper across A2
5	Jumpers across A0 and A2
6	Jumpers across A1 and A2
7	Reserved for the Mac's CPU

Disk Tools

Basic maintenance *is* important. A hard drive is a physical device that needs care, and failing to take care of it can be fatal to your data. Always have a few disk tools on hand to repair problems. MacTools and Norton are a good place to start. Both can defragment (optimize) disks, find and correct disk errors, and help restore deleted files, accidental or otherwise. Before running even the first test, use either one to create an emergency diskette and a defragmenting diskette. That way, if something goes wrong with a drive, you can boot from the diskette and usually get to your data. Since the advent of System 7.1, this is one of the few ways to create a bootable diskette.

Defragmentation (or optimization) can speed your drive. The Mac uses space as it becomes available, so if you throw away five or six files, five or six areas open up on the disk for new data. If you then install a new application or save a new file, that data could be written into three, four, five, or more different places. Computers handle the situation fairly well, putting markers at the beginnings and ends of each file fragment to say, "The next piece is over there." But if one of those markers is lost or damaged, the whole file can be lost. Defragmentation puts all the pieces back together again and should be done at least twice a year. If you're moving a lot of large files around and keep your drive nearly full, do it once a month.

There are scores of insidious disk errors that can creep in and destroy your data. They're just part of working with hard drives, and there's nothing you can do to prevent them. You can, however, keep them from causing problems by running a disk tool, such as MacTools Disk Clinic or Norton's Disk Doctor. The tools find everything from broken bundle bits through machine-crashing boot-block errors. Regular backups help, too. If a tool finds an error it can't fix, a full backup, reinitializing the drive, and then restoring the data will fix it.

For formatting and initializing disks, Apple's HDSC utility is good but not great. It only works on Apple drives. FWB's Hard Disk Toolkit (HDT) and Silverlining both provide more flexibility. Anubis makes software that enables you to set up inexpensive RAID arrays, striped or mirrored, as well as initializing and formatting drives.

Summation

A hard drive is a physical device, and as such it will eventually fail, but you're much more likely to have moved up to a larger, faster drive before that happens. If you have proper backups and have been taking care of the drive, even a failure won't mean the end of your business or the loss of a client. Shop carefully and always buy more than you need. In the end, you'll use it. Besides, with gigabyte drives falling to around \$300, it's not all that expensive to have more than you need.

For More Information

Before buying, contact several companies to request information. Their offerings change fast, and with the recent drop in hardware prices, there might be bargains to be had.

If you'd like to learn more about storage, point your Web browser to <http://alumni.caltech.edu/~rdv/comp-arch-storage/FAQ-1.html>. You also can subscribe to the newsgroup `comp.arch.storage`.

Please see the Appendix for more manufacturer information.

Scanners

It wasn't all that long ago, less than 10 years, that the early Mac scanners came along. The ThunderScan attached to an ImageWriter actually replaced the print head and used the printer itself to feed paper past what can only be called a crude scanning head. It worked—sort of—and it was the only game in town. Black-and-white, low resolution, slow and clumsy, but in its day, it was still a joy.

Hand scanners came along soon thereafter and were quite a boon with 4- and even 8-bit grayscale. Unfortunately, scanning anything more than four inches wide meant making several passes and, because the human hand just isn't all that accurate, the disparate parts of the scan rarely matched. Special software helped stitch the images together, but it was still a weak solution. There are still quite a few hand scanners on the used market, so if you're considering a hand scanner for occasional use... don't. A used flatbed is not expensive and is a far, far better tool.

Prior to the boom in flatbed scanners, desktop publishing (DTP) and graphics professionals had to go to service bureaus and pay for drum scans, which are still the best scans available. It might take overnight or longer, and fast turnarounds cost more, but even slow turnaround was expensive. Now that flatbeds have swept the market and even begun to move into the drum-scan range, graphics professionals can do just about everything they need at home with the click of a mouse.

If you want to know...

Go to...

Do scanners require extra RAM?	212
Is there an alternative to scanning?	213
What is meant by the Dmax rating?	212
What makes a drum scanner better?	213
What should I look for in a DPI rating?	210
How can I scan slides?	218
Is there a significant difference between 24-bit and 30-bit scanners?	211
What does <i>interpolation</i> mean?	211

The Technology

Scanners use CCDs (charge-coupled devices) to “see” images. In flatbed scanners, they see the image through a pane of glass, which is one reason drum scanners are still superior—they look directly at the image. Either way, the device looks at the image, breaks it down into discrete units, assigns each unit a numerical value for color and brightness, and *voilà!*—the Mona Lisa. Beyond that, let’s face it, who cares how they work? If you are interested in how things work, point your Web browser to <http://www.infomedia.net/scan>.

Almost every scanner comes with some form of correction and editing application. Many are effective, and some are not. If you’re using a scanner to do serious work, go with Photoshop and, for large images, Live Picture. No other tools on the market have as much power or control over an image.

In recent months, a number of photo-only scanners have come into the market. They’re fine for home or casual use, but because they’re meant for serious graphics work, they won’t be covered here. (All the topics covered do relate, but the machines themselves aren’t discussed.) Single-page, grayscale scanners, such as Visioneer’s PaperPort, also go by the wayside in this chapter, because they’re generally dedicated to text input or very low-resolution work.

Resolution

Like a printer, the higher the resolution, the finer the image. For professional-level work, look for 400 DPI. Even if your best output device is only 300 DPI, it’s better to have extra data rather than risk losing some in translation. If you’re doing photographic-quality reproduction that will be enlarged, be it a slide or a small image becoming a poster, look for even higher resolution, at least 600 DPI, and preferably more. Line art or OCR (optical character recognition) also requires at least 600 DPI, especially if you’re enlarging small images.

Ratings

OmniPage (OCR)	1	2	3	4	5
Ease of Use					
Great Features					
Coolness					
\$ Value					
Overall Rating					

NOTE

There's more to resolution than DPI though. Scanning is a precise process in which a scanning head slides or ratchets past an image, and if either the head or the image aren't stable, the resulting scan is fuzzy. Look out for scanners that jitter as they scan, bouncing around in such a way they might make a lightweight table dance while they work.

Not surprisingly, manufacturers stretch the facts and tell a few stories about resolution; stories that don't have good endings. Watch for the word *interpolation*. As with printers, it means the scanner is adding an extra dot of its own between the larger dots, and making a 300-DPI scanner into 600-DPI scanner does smooth line edges. It does not, however, provide better grayscale or color definition.

Manufacturers also give two numbers; one of which can be misleading. If a device says it's 300×600, the scanner is really only 300 DPI. The lower number is the horizontal resolution and the true resolution of the scanner, whereas the second number is the vertical resolution and is interpolated, meaning extra dots, not extra information.

Color Depth

Until fairly recently, 24-bit scanners were the standard, but 30-bit scanners are coming into their own as prices fall. This is a technological tidbit worth illustration because 30-bit scanners are more expensive, and you may or may not need one.

As noted before, scanners break down images into numerical units, and in a 24-bit scanner, there are only 8 bits of tone available for each pixel. That's 256 levels, which is a lot of levels, but not all bits are created equal. There are diminishing returns around the seventh and eighth bits, and the information in them, being less accurate, makes for weak grays and shadows. Ideally, one would simply throw away the inaccurate bits and go with the accurate ones, but that means throwing away good data and turning a 24-bit scanner into a 20-bit scanner.

30-bit scanners, however, bring in extra data and even clean it up on-the-fly via tonal correction. How much data do they capture? A lot. Instead of 256 levels of tone, a 30-bit scanner brings in 1024 levels, which is more than a billion colors. In comparison, 8-bit is 256 colors and 24-bit is 16.7 million. When you start making corrections and massaging an image with billions of colors, there's more data available to adjust, hundreds of millions of bits more. It shows up most of all in shadows and gray areas. A scanner without enough resolution will, on raising the gamma to bring out a detailed shadow, burn the lighter areas of the image, pushing them to white.

Do you need that much resolution? If you're doing commercial-level photographic work, more than likely yes. If you're doing illustration that isn't entirely photo-realistic, you probably don't need 30-bit color, although you might appreciate having the extra information on images with a lot of shadows. Images with saturated colors and not too much shading scan just

fine in 24 bits. And the cost? A 30-bit scanner might be several hundred dollars more and have more bells and whistles than you need. It's the difference between buying a serviceable commuter car and a luxury sedan.

Dynamic Range

A scanner's dynamic range is its capability to handle a range of tones, sometimes called the Dmax rating. A low dynamic range burns bright tones (making them too bright) and flattens areas of contrast (making them uniform). It's a measure of variability between the brightest white and the darkest black and how many levels there are in between. For professional-level scans, look for dynamic ranges of 3.3 or more.

RAM

The bigger the scan, the more the RAM, and scanners want a lot of RAM. Actually, the application into which the scan is going requires the RAM, slide scanners most of all. The average slide scanner wants 16MB, so if you're underinvested in RAM, buy more when you buy the scanner. If you have a Power Mac, for example, with 32MB of RAM, you have just enough to run the Mac and a full-size graphics application, and said application won't have a lot of breathing room. Low RAM situations can slow scanning to a crawl, which introduces opportunities for visual noise as the scanner creeps along. Ideally, the scanned image should fit entirely in RAM, and a high-resolution image of 2600×4000 needs about 30MB. That's 30MB *over and above* what the system software and application are using.

One way to use less RAM is to make lower-resolution scans. The more DPI, the more RAM required, so if you're doing high-resolution scans only, just keep buying RAM.

I only upgrade if I see the upgrades as useful tools, not extraneous decorations. Sometimes you just have to step off the technology bandwagon and enjoy what ya got.

John Lopes
Graphics Supervisor

Slide Scanners

Until the last year or two, slide scanners were the exclusive realm of service bureaus, but tools, such as Nikon's Coolscan and add-on boxes for flatbed scanners, have brought them into the mainstream. Resolutions are much higher for slide scanners. Minolta's QuickScan 35, for example, reaches 2,820 DPI. Dedicated slide scanners are smaller and take up less desk space than a full-size flatbed.

They're fairly straightforward—slip in a slide, start up the software, and wait about a minute. If you're in a high-speed environment, be sure to look for a scanner that's fast, has an autoloader, and be sure to have a machine with a lot of RAM.

Flatbed scanners often can handle slides with the addition of a light box that goes on top of the scanning bed. Others have dual media handlers and do both. The light box method isn't as accurate as a dedicated slide scanner but is sufficient for occasional or casual use. Note that even dedicated slide scanners in the under-\$3,000 range aren't professional-quality devices. For professional-level slide scans that will be blown up to full-page size, you'll have to move up to a drum scanner.

Drum Scanners

A drum scanner can do what no flatbed can do—scan at 10,000 or 11,000 DPI with 36-bit color. Drum scanners use a different technology from flatbeds called a PMT, or a photomultiplier tube. They're expensive, but if photographic-quality is required, move straight to a drum and be prepared to pay more than \$10,000. Although they're far more precise and usually faster, one of the downsides of a drum scanner is that the media has to fit the drum. A flatbed scanner scans anything you can lay on a plate of glass, which is also their downfall. A glass plate can introduce distortion, whereas a drum scanner looks directly at the image adhered to a drum. The scan heads on a drum scanner don't move, the image does, and that also makes a more accurate scan.

Alternative to Scanning

Kodak's Photo CD can take over for your scanning needs if you don't mind sending film off in the mail. A graphics professional with a day-to-day need for scans, bringing in sketches, line art, photographs, and possibly a little OCR (optical character recognition) should have a scanner on the desktop, but for the occasional scan, Photo CD is as handy as can be. The images come back in six different resolutions ranging from as high as a drum scanner to a little more than screen resolution. Why spend thousands on a high-end scanner if all you need is a half-dozen really good scans each month? Contact Kodak for pricing and turnaround information.

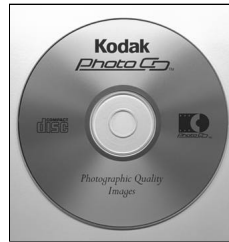

Figure 11.1
Kodak's Photo CD can handle scanning for you.

Market Offerings

The following are a few of the market offerings. Specifications change fast, so use these numbers for comparison only. You can expect to find features in groups; a 30-bit scanner, for example, generally interpolates much higher than a 24-bit scanner.

Flatbed Scanners

Most of these scanners come with optional light boxes to make them into slide scanners, but they're primarily for reflective art. Most also have optional sheet feeders, so you don't have to tend them while scanning a stack of documents or images. All come with correction and editing software, the most powerful of which is Adobe's Photoshop.

Agfa

Agfa, long a player in the image-manipulation market, makes five scanners, ranging from the StudioScan IIsi, a 30-bit scanner with a resolution of 400×800, interpolating to 2400×2400, to the SelectScan Plus, an 8000×8000 DPI commercial tool.

The DuoScan is a relatively high-end offering with a resolution of 1000×4000 with interpolation up to 4000 DPI. Rather than an add-on light box for slides, the Agfa handles reflective as well as transmissive media (photos or slides) in one unit. A lower slide-out drawer carries transmissive media ranging from 35mm slides to 8×10 transparencies. The unit can scan one image while you're loading another into the other handler. Thus, you can scan a slide while you're laying a photograph on the upper scan plate.



Figure 11.2
Agfa's DuoScan, a professional-level scanner.

Apple

Suffering from early performance problems, Apple's scanners have since cleaned up their act. The Color OneScanner 600/27 brings images in at 27-bit (134 million colors), allowing greater range than 24-bit scanners and without the cost of 30-bit. It has a resolution of 300×600, interpolating up to 2400×2400. The OneScanner ships with software that automatically starts scanning when you put a page on the bed.

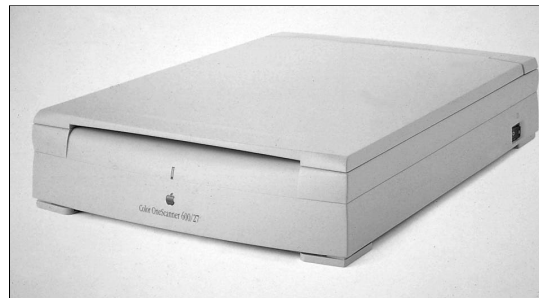

Figure 11.3
Apple's OneScanner is much improved over earlier models.

Ratings

Apple	1	2	3	4	5
Ease of Use	████████████████████				
Great Features	████████████████				
Coolness	████████████████				
\$ Value	████████████████				
Overall Rating	████████████████				

Epson

Epson makes three color scanners as of this writing, the ES1200C, ES1000C, and the Action Scanning System II. The ES1200C is one of the best buys right now. With a resolution of 600×1200, interpolating to 4800 DPI at 30-bit color, it only handles 8.5×11-inch media, and that fills the bill for most scanning needs.

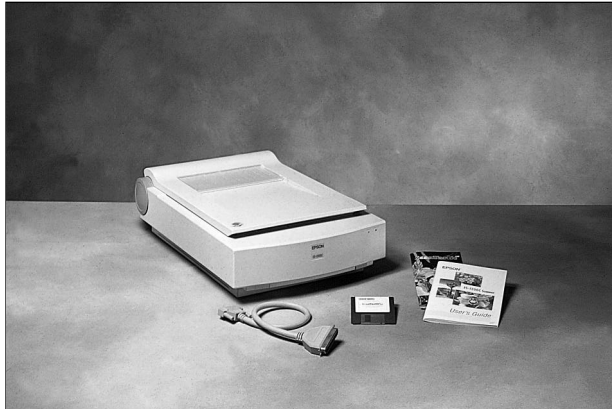

Figure 11.4
The Epson ES1200C is a bargain.

Hewlett-Packard

HP had the market well wrapped up a few years ago, until the flatbed scanner wars began. They still make some of the better scanners around though, and their line currently includes the ScanJet 4s, 4p, 4c, and 4si. They are planning a combination printer/fax/copier that should be out by the time this book is published.

The 4c is their top-of-the-line desktop model. (The 4si is a stand alone network device.) It scans at 600×600 DPI, interpolating up to 2400 in 24-bit color.

Ratings

Hewlett-Packard	1	2	3	4	5
Ease of Use	████████████████████				
Great Features	████████████████████				
Coolness	████████████████████				
\$ Value	████████████████████				
Overall Rating	████████████████████				

LaCie

LaCie's series has done well in the market and offers the SilverScanner III, DTP, and Pro. The SilverScanner III is a 30-bit device scanning at 300×600 DPI, interpolating to 4800×4800 DPI. The DPI moves up a notch to 400×800 DPI, interpolating 3200 DPI, and the Pro (despite its name) is actually the low end of the line. It's only 24 bits at 300×600, interpolating to 2400×2400 DPI.

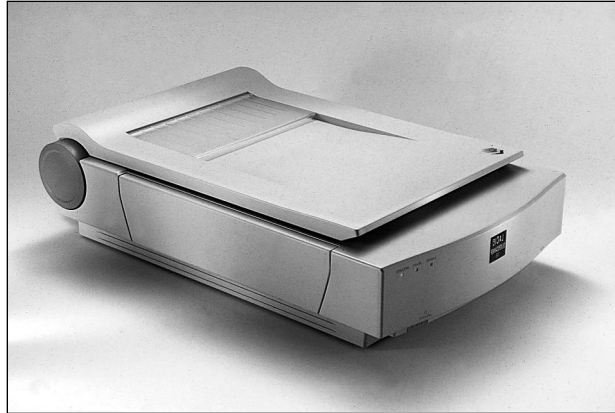

Figure 11.5

The LaCie SilverScanner III interpolates higher than most.

Primax

The DeskScan is an entry-level 24-bit scanner that scans at 600×600 DPI, interpolating to 1200. It only holds letter and A4-size paper, and it's one of the few scanners left that must make three passes to pick up all three colors, but it's a less expensive solution.

Relisys

Relisys recently revamped its entire line, removing the Reli series and creating two scanners—the Taurus and Scorpio. The Taurus is a 600×1200 DPI scanner, interpolating up to 9600×9600. The Scorpio is its little brother and only scans at 300×1200 DPI, interpolating up to 2400×2400. Both are 30-bit devices and both incorporate “Cold Scan,” which helps lower the scanner's bulb temperature, thereby lengthening its life.

ScanView

Encroaching on the flatbed market is ScanView's ScanMate F8. It handles transparencies as large as 8×17 inches and prints up to 11×17 inches. At 4000 DPI, it's above the average flatbed and has optional calibration and separation software, as well as automation software for high-volume environments.

Ratings

Umax	1	2	3	4	5
Ease of Use	████████████████████				
Great Features	████████████████████			████████████████████	
Coolness	████████████████████		████████████████████	████████████████████	
\$ Value	████████████████████			████████████████████	
Overall Rating	████████████████████			████████████████████	

Umax

Umax makes many scanners, ranging from the Vista S6E for simple, low-cost scans, to the Mirage D-16L, a dual-lens, high-resolution, 30-bit device. Even the Vista S6E is 24 bits with 300×600 resolution, interpolating to 4800 DPI, and includes optional sheet feeder and slide/transparency adapter. The Mirage D-16L handles 12×17-inch reflective or transmissive media at a real resolution of 400×800 DPI, interpolating to 9600 DPI and 30-bit color.

Slide Scanners

Although they're better than a light box on top of a flatbed scanner, a slide scanner's not quite up to drum-level scans yet. They are, however, remarkably powerful.

Kodak

Alongside Photo CD, which can take the place of an occasional scan, Kodak makes a line of film scanners. The RFS 2035, for example, scans with a 2000×3000 DPI resolution at 36 bits. It ships with a loader that enables you to add slides while a scan is in progress, somewhat like a slide projector.

Minolta

Scanning at 2800 DPI and 30-bit color, the QuickScan 35 starts out a good machine, but it uses an unusual pair of connectors, making it more difficult to plug into a SCSI chain. It does come with a manual focus ring, however, a familiar tool for photographers.

Nikon Super Coolscan

Nikon opened the slide-scanning market with its small Coolscan. It offers a slide feeder that accommodates 50 slides (the slides must be mounted). At about a minute per slide, that's an hour of unattended operation. It has three colored lamps and makes three passes for each capture, and to keep colors stable, uses light-emitting diodes (LEDs). Unlike filters, they won't fade or change color with time and heat stress.

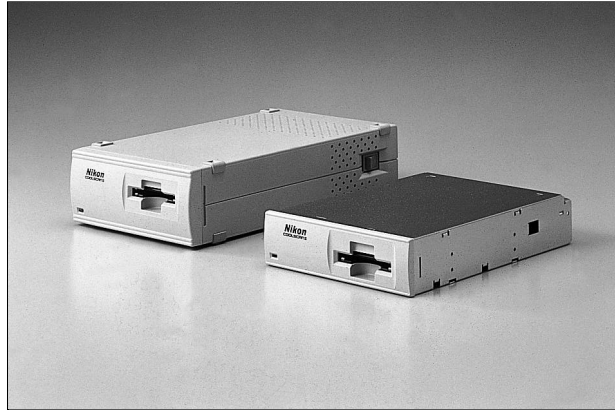

Figure 11.6
The Nikon Super Coolscan.

Polaroid SprintScan

Polaroid makes two slide scanners, the SprintScan 35/ES and the 45. The 35/ES is the smaller of the two and handles only 35mm media, mounted or unmounted, scanning at 2700×2700 DPI in 30-bit color. The SprintScan 45 can take transmissive media up to 4×5 inches, mounted or not, and scans at 2000×4000 DPI in 36-bit color.

Drum Scanners

The following are relatively low-end drum scanners. The high-end models cost in the \$50,000 range and are beyond the scope of this book, but the contact information in the appendix will put you in touch with the high-end producers.

Eurocore Hi Scan

A 36-bit scanner capable of 3000 DPI, the Eurocore Hi Scan is one of the less expensive drum scanners on the market. It can handle media up to 6×12 inches and has an unusual enclosure, like a flattened version of Darth Vader's helmet.

Optronics

Optronics starts out at the high end of desktop devices and goes up from there. The ColorGetter Falcon 5000 DPI at 36 bits can handle media ranging from 35mm to 10.5×12 inches.

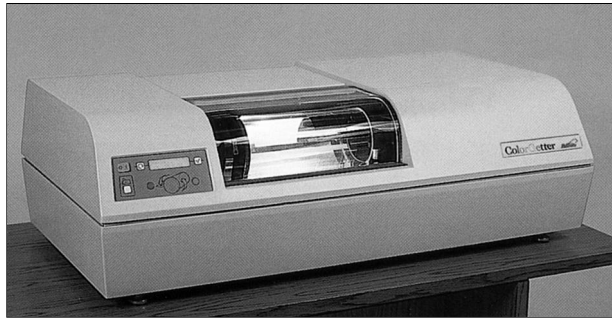

Figure 11.7

Optronics Falcon ColorGetter is one of the less expensive drum scanners.

ScanMate

ScanMate's Magic is their move into desktop-range drum scanners. It only has one PMT (photomultiplier tube) and makes three passes for a full color image. Its resolution is 2000 DPI with 36 bits of depth and is one of the few drum scanners that's moved into the desktop range and only holds pages up to 8.5×11.5 inches.

Technical Issues

Hooking up a scanner is like hooking up any other SCSI device—make sure it has a unique ID and is properly terminated, and all should be well. Should be. Scanners tend to be a little more picky about their location in the SCSI chain. Most come with a recommended position, first or last, and if yours is having trouble, try moving it from one to the other. They rarely work well in the middle of a chain.

Because they're expensive, it's a good idea to share a scanner over a network. One company that makes such a tool is Stalker Software. It works with Open Transport and the PCI Macs.

Finally, drum scanners require considerably more skill to use than flatbeds. Media has to be properly adhered to a drum that spins at thousands of RPM, so if you're not already familiar with drum scanning, be prepared to spend some time learning a few new skills.

If you'd like more information on scanning, point your Web browser to <http://www.infomedia.net/scan/> or check out the newsgroups `comp.sys.mac.graphics` and `comp.sys.mac.hardware`.

12

Printers



The Revolution

Macintosh started the desktop publishing revolution with the lowly LaserWriter, a printer that still has value today, although it has been far outstripped by newer models. Even before the LaserWriter, an original Mac with a whopping 256KB of RAM and an Imagewriter could do something no previous desktop publishing system could—WYSIWYG (What You See Is What You Get). The Imagewriter's long, grinding 72 DPI printouts were replaced by the LaserWriter's tremendous 300 DPI resolution. Both have since been surpassed by black-and-white printers that can output at 1200 DPI and up to 12 pages per minute, faster workgroup printers, plus a variety of color printers.

If you want to know...

Go to...

Should I buy inkjet or laser?	222-223
What's the difference between LPI and DPI?	224
What printer drivers will I need?	228
Should my printer have RAM?	227
Are print speed specifications absolutely accurate?	227
Why PostScript?	226
What does dye-sublimation mean?	223
Do inkjet printers require special paper?	222
What is Interpolation?	224

Although color printers aren't as fast as black-and-white, they're a lot faster than overnight delivery from a service bureau. A single color page might take more than 10 minutes to print, whereas black-and-white outputs at approximately eight pages per minute. Just as the neighborhood typesetter disappeared with the DTP boom, some service bureaus have suffered with the advent of devices like the Tektronix 340 and Fargo's line of thermal-wax/dye-sublimation printers.

Technology is changing fast. Before buying, call any and all companies with products that fit your needs and budget, and ask for sample outputs. Most are happy to send pages with text and graphics, and you can compare, say, the Tektronix Phaser with the HP855c, side-by-side. The Appendix contains a list of manufacturers with contact information.

How Printers Work

This section doesn't teach you the physics of inkjet, laser, and color printing, but it does provide the basics on just how they do what they do. It also positions the various devices, relative to use and accuracy, to help you shop.

Inkjet Printers

As the name implies, inkjet printers spray fine jets of ink onto the paper from a moving print head. They're generally the least expensive way to put an image on paper, both in terms of hardware and consumables (ink). Because the ink is wet when it hits the paper, it tends to spread, so at 300 DPI (dots per inch), an inkjet might not be as sharp as a 300 DPI laser printer. Inkjets, however, have come a long way, and many offer resolutions as high as 720 DPI, better than some lasers. They also print in color as well as black-and-white.

Paper makes a difference, especially with inkjets, and many have special, coated paper for the highest-quality output. Don't expect a 720 DPI inkjet to produce crisp, clear images on inexpensive typing paper.

To output color, the print head sprays three or four colors. If three, they are cyan, magenta, and yellow (CMY). If four, they are CMYK, the "K" standing for black. CMY printers have an extra black cartridge for pure black. Mixing CMY to create black is called composite black, which isn't always entirely black. Thanks to the aforementioned color spread, blacks can have inappropriately colorful edges and be brownish rather than black.

Replacing the CMY with an all-black cartridge is a weak solution. It's possible to print solid black, but in order to mix that black with color images, the page has to go through the printer again, and inkjet printers aren't

known for their accurate paper paths—the registration will almost certainly be off. A printer with all four colors in one print head, CMYK, costs more, but it's money well spent. If you plan to do more than occasional color, buy a CMYK device.

Laser Printers

Laser printers are by far the bulk of the market, and there is indeed a laser in each one. Some “laser” printers actually use light-emitting diodes (LEDs) in place of the laser, but the process is similar. When you hit ⌘-P, data goes to the printer, and a stream of light shines onto an organic photoconductor drum (OPC). The OPC drum is light-sensitive and holds an electric charge. That charge is then selectively removed by a laser beam. The laser draws your page electrically on the charged drum.

The toner has a reverse charge, so it sticks to the drum. As the drum passes the toner, the toner sticks, and the paper passes over the drum and through a fuser with heat and pressure, which bonds the toner to the page. Toner itself is more than just a powder; it's actually tiny plastic beads. Different printers use different kinds of toner. That for a 1200 DPI printer is considerably finer than for a 300 DPI printer.

A color laser works much the same way, but the drum is charged and selectively uncharged by the laser four times, once for each color. After all four colors have been applied to the drum, a page is pressed against the drum, and the fuser bonds the image to the paper.

Thermal-Wax Printers

Thermal-wax and color laser printers are in competition. They're entirely different technologies, but their respective outputs vie for superiority. Thermal-wax uses a plastic ribbon coated with cyan, magenta, yellow, and black wax pigments. The ribbon is heated, and the pigments melt onto the page, giving images well-saturated colors. Thermal-wax is good for basic color proofing and excellent for transparencies. There's still some dithering and colors might not be quite right, but they're definitely a step up from the average laser.

Dye-Sublimation Printers

Dye-sublimation printers are the top end of the desktop color line. Like thermal-wax, they use ribbons, but they're coated with dye rather than wax. That dye, when heated, sublimates (changes from a solid to a gas) and adheres to the paper very accurately. Dye-sublimation printers don't dither; they have true, continuous-tone colors and photographic quality

output. Their downside is cost, both in consumables and hardware. The ribbons aren't cheap and the printer cost itself is at the top end of the desktop range. An exception to the rule is Fargo's Primera Pro, which is less expensive than most color lasers.

Imagesetters—DPI vs. LPI

Imagesetters are the final word in output. There are two basic technologies, capstan and drum. Capstans tend to be the low end and are used for black-and-white and simple color. Drum scanners are the high end and are used for painfully high-quality reproduction.

In drum and capstan, a laser writes the image on film, one piece of film for each color, CMYK, and that film is used to create plates, which are in turn used to print pages. Desktop imagesetters also print to paper.

While output from laser printers is measured in DPI, imagesetter output is measured in LPI (lines per inch). The standard for magazine publishing has been 133 LPI for years, and that standard is rising. Quite a few commercial imaging systems now output at 150 LPI.

Dots and lines per inch are just what they sound like. A 600 DPI laser prints 600 dots in a one-inch line, and a 150-line imagesetter prints 150 lines in one inch. DPI and LPI, measurements however, are intrinsically different, and no laser printer can come close to a well-heeled imagesetter, which runs as high as 4000 DPI. A 600 DPI printer can only print about 50 imagesetter lines in an inch, nowhere near magazine standards. And, of course, imagesetters are expensive, to the tune of tens of thousands of dollars.

Interpolation

Some laser printers reach their highest resolution through *interpolation*. A 600 DPI printer that uses interpolation may only be a 300 DPI printer adding extra dots. Interpolation takes the average distance between dots and adds an extra smaller dot, which helps make edges sharp. Such a printer, however, doesn't handle the 600 (or 1200 DPI) information and therefore doesn't print halftones as well. If your work relies on halftones, spend the extra money and avoid interpolation; buy a true 600 or 1200 DPI device. If most of your work is text, interpolation may serve you well.

NOTE

A halftone is a black-and-white dither used to create a smooth gray shade.

Assessing Your Needs

Although it would be nice if everyone had an imagesetter and printed to the highest possible resolution, it's hardly feasible. The trick is to decide just how much you need to spend for your needs and then let the service bureau carry the rest of the cost. That's what service bureaus are for—they pay for \$100,000 Linotypes or Birmy setters so you don't have to.

Color laser printers, and even the better inkjets, are now good enough for basic proofs and checking composition and design before going to press. They're not up to the task of commercial printing, but they will fill the bill for newsletters, presentations, and more photorealistic uses than just bar charts.

For professional graphics artists, anything less than an imagesetter is only a proofing tool, output to show clients or use for personal proofing before going to the printer for final output to film. The colors are never quite what a Pantone or Trutone book show, and the final imagesetter output from a service bureau will be at least a little different.

The top of the line in color proofing are the dye-sublimation printers. They're as close to a press check as a day-to-day user can get without going to the press. If you do a lot of color work, look into dye-sublimation, some of which also do thermal-wax output, which is less expensive and faster.

Black-and-White or Low-Color Solutions

If most of your output is black and white—300 DPI newsletters and text—you can get by with an inkjet or, for PostScript, a laser printer. Although magazines and advertisements put all the glamour in high-end color printers, not everyone needs one, so don't be fooled by the hype. If your output includes images of people or graphics, go with at least 600 DPI. A 300 DPI image of people (a half-tone) is fuzzy and muddy at best.

If you do a lot of grayscale work, 1200 DPI black-and-white printers are a good buy. They produce an excellent image for newsletter and grayscale publishing. Several models print fast enough and are hardy enough to be used for short runs, hundreds of pages.

If your color needs are basic—presentations, color text, bar charts, and internal newsletters, look into inkjets and color lasers. At 720 DPI, they're fast and economical, and even the lower resolutions are sufficient for many uses.

TIP

If you're printing grayscale at 600 or 1200 DPI and then taking the output to a copy shop for mass reproduction, make sure they're copying everything you're printing. All too often an excellent 600 DPI print turns into a muddy mess on an inexpensive copy machine. If an inexpensive copy machine is all that's available, consider buying a less expensive printer and simply avoiding graphics. You'll save money, frustration, and save face.

Basic Color Solutions

Color laser printers and thermal-wax work well for newsletters, basic color proofing, and short runs for presentations. Several inkjets now reach into the color laser range and are worth considering. Again, neither a color laser nor an inkjet is accurate enough for color proofing (prepress), but if the color laser or inkjet is your final output, it's a fast, inexpensive solution. If you aren't a professional graphics artist and simply want color output of acceptable quality, a color laser will likely stand in good stead.

Professional Color Solutions

Graphics artists and illustrators who need to print many versions for their own proofs or to show clients should look at thermal-wax or dye-sublimation printers. There are several on the market that do both, the wax being less expensive for quick checks and the dye-sublimation better for either client presentations or the last proofing before going to press.

If you or your company has money to spend, there are a number of desktop imagesetters on the market. Their prices range upwards from \$20,000 but are the final word in a prepress check.

PostScript

PostScript, Adobe's cash cow for many years, gave publishers a device-independent standard. A PostScript image printed on a 300 DPI printer comes out at 300 DPI. On a 1200 DPI printer, it comes out at 1200 DPI, and so on. The downside is complexity and price. PostScript is expensive, and few have been in publishing long without seeing the ubiquitous "PostScript error -39" or a similar message.

Prior to PostScript and now alongside it is Apple's QuickDraw. It's not as complex or detailed as PostScript, but it is fast and simple, and most inkjet printers rely on it. If you do a lot of PostScript work, go with a PostScript printer or you might find your printouts nothing more than gray boxes. A QuickDraw printer is stymied by a pure PostScript output.

Laser printers, by and large, have PostScript, and if you do a lot of PostScript work it's worth having. If a printer seems too inexpensive for its capabilities, it may either lack PostScript or may have a PostScript emulator. Check the specs before you buy. An emulator allows the manufacturer to avoid paying the heavy fee to Adobe for the PostScript code, but because that code is occasionally updated and changed, emulators occasionally fail, producing PostScript errors.

Print Speed

Pages per minute ratings can be misleading. Although a printer might claim to print eight or ten pages per minute, those are “perfect” pages—one font, plain text, and no graphics. A page with text, color, and graphics can take a lot longer, several minutes per page instead of several pages per minute. Check the printer’s specifications for details on how many pages of mixed text and graphics a model can handle, and keep in mind that the manufacturer lists the fastest situation. Your print times likely will be a bit slower, and possibly a lot slower if you print highly complex pages.

A large, complex image outputting to a small, slow printer takes a long time to process. Many inkjet and even some dye-sublimation printers use the Mac itself to process the image, so check to see how much, if any, RAM comes with the machine. PostScript printers using the Mac’s RAM to calculate all the requisite curves, angles, and junctions may take a long time to finish. One way to speed the process is with additional printer RAM. If the printer has enough RAM, it can hold the whole image, enabling your Mac to get back to business. If the printer doesn’t have enough, your Mac is held hostage while the printer requests each segment of the image as it’s processed.

If you’re connecting via LocalTalk, print times will be longer than if you’re connected via Ethernet or a faster network. Big images have a lot of data to transmit, and LocalTalk just isn’t fast enough to keep up with a fast printer. If you’re on a network with several machines printing to the same device, network traffic can choke the jobs and bring printing nearly to a standstill. This is where a print server, a lot of printer RAM, or a hard drive on the printer come in handy.

Fonts

The number of fonts built into a laser printer only matters if you use those fonts often. Graphics designers and illustrators generally use a wide range of nonstandard fonts, so having Palatino, Times, Courier, and so on built in really doesn’t help. If you need fast output and want lots of fonts immediately available, look into a printer with a built-in hard drive. The fonts are loaded on the drive, so they need not be sent to the printer each time, which cuts network traffic as well as print time.

TIP

In a networked environment where many large graphics are printed, consider a print server. The server is a device or drive that’s dedicated to running print jobs. All print jobs go to it first, and it spends its time keeping the printer running instead of you either waiting on the printer or the network.

Connectivity

Not even all of Apple's printers ship with LocalTalk now, so be sure the model you order comes with a port you can plug into. Many printers come with multiple connection methods, so also be sure to use the one that best suits your needs. Although LocalTalk is easy and inexpensive, if the printer you're considering comes with built-in Ethernet and you're printing large images, it might be time to move up to Ethernet.

Ratings



Macs can use PC printers with a little extra effort. GDT Works sells a kit that can attach almost any PC printer to almost any Mac. This is useful not just if you have a PC printer in the office but also if you use a Mac on the road. If your job involves presentation graphics, being able to print and correct at a PC-only house can be a lifesaver. GDT also has products that enable PostScript printing from the Apple StyleWriter.

Drivers

The most common reason a printer won't print (besides not being plugged in or not selected in the Chooser) is an out-of-date driver. It shouldn't be a problem given the Mac's easy setup and maintenance, but drivers go out-of-date with alarming regularity. Always check with your printer's manufacturer after upgrading system software or even a major application software upgrade. Hewlett Packard has, in the last year, released several updates to keep up with System 7.5.x. Some of them have had trouble with background printing, a problem fixed with other, newer drivers, so don't throw away your old driver after picking up a new one. The old one might actually work better than the new one (if it works at all).

Listing every possible printer/driver combination would be impossible, but the following table describes all the Mac printers and the drivers they require. (Courtesy of Apple Computer.)

Printer	Driver Version	Cable
ImageWriter	7.0.1	Serial
ImageWriter GX	1.1.1	Serial (5) (7)
AppleTalk Image-Writer and LQ	7.0.1	LocalTalk (1)
LQ ImageWriter	7.0.1	Serial
ImageWriter LQ GX	1.1.1	Serial (5) (7)
StyleWriter	7.2.3	Serial
StyleWriter II	1.2	Serial/Shareable (2) (9)
StyleWriter GX	1.1.1	Serial (5) (7)
StyleWriter II GX	1.1.1	Serial/Shareable (5) (7)
Portable StyleWriter	1.0.1	Serial
Color SW Pro	1.5	Serial/Shareable (2)
Color StyleWriter Pro GX	1.0	Serial/Shareable (5)
StyleWriter 1200	2.0	Serial/Shareable (2) (9)
Color StyleWriter 1500	2.2	Serial/Shareable (2), LocalTalk (10)
Color SW 1500 GX	1.0	Serial/Shareable (5)
Color StyleWriter 2200	2.1	Serial/Shareable (2)
Color SW 2200 GX	1.0.1	Serial/Shareable (5)
Color StyleWriter 2400	2.1.1	Serial/Shareable (2), LocalTalk (3)
Color SW 2400 GX	1.0.1	Serial/Shareable (5) (7)
Color StyleWriter 2500	2.2	Serial/Shareable (2), LocalTalk (10)
Color SW 2500 GX	1.0	Serial/Shareable (5)
Apple Color Printer	1.0	SCSI/Shareable (2)
LaserWriter LS	7.2	Serial
LaserWriter 300	1.2	Serial/Shareable (2)
LaserWriter 300 GX	1.1.1	Serial/Shareable (5) (7)
LaserWriter NT	7.1.2	LocalTalk
LaserWriter NT	8.3.2	LocalTalk (6)
LaserWriter NT GX	1.1.2	LocalTalk (5) (7)
LaserWriter NTR	7.1.2	LocalTalk
LaserWriter NTR	8.3.2	LocalTalk (6)
LaserWriter NTR GX	1.1.2	LocalTalk (5) (7)

continues

Printer	Driver Version	Cable
LaserWriter SC	7.0.1	SCSI
LaserWriter IISC GX	1.0	SCSI (5)
LaserWriter 300	1.2	Serial/Shareable (2)
LaserWriter 300 GX	1.1.1	Serial/Shareable (5) (7)
LaserWriter 320	8.3.2	LocalTalk
LaserWriter 320 GX	1.1.2	LocalTalk (5) (7)
LaserWriter	7.1.2	LocalTalk (4)
LaserWriter	8.3.2	LocalTalk (6)
LaserWriter GX	1.1.2	LocalTalk (5) (7)
LaserWriter Plus	7.1.2	LocalTalk (4)
LaserWriter Plus	8.3.2	LocalTalk (6)
LaserWriter Plus GX	1.1.2	LocalTalk (5) (7)
LaserWriter SC	7.0.1	SCSI
LaserWriter IISC GX	1.1.1	SCSI (5) (7)
LaserWriter IINT	7.1.2	LocalTalk
LaserWriter IINT	8.3.2	LocalTalk (6)
LaserWriter IINT GX	1.1.2	LocalTalk (5) (7)
LaserWriter IINTX	7.1.2	LocalTalk
LaserWriter IINTX	8.3.2	LocalTalk (6)
LaserWriter IINTX GX	1.1.2	LocalTalk (5) (7)
LaserWriter Iif	7.1.2	LocalTalk
LaserWriter Iif	8.3.2	LocalTalk (6)
LaserWriter Iif GX	1.1.2	LocalTalk (5) (7)
LaserWriter IIg	7.1.2	LocalTalk, Ethernet
LaserWriter IIg	8.3.2	LocalTalk, Ethernet (6)
LaserWriter IIg GX	1.1.2	LocalTalk, Ethernet (5) (7)
LaserWriter Select 300	1.2	Serial/Shareable (2)
LaserWriter 300	1.2	Serial/Shareable (2)
LaserWriter 300 GX	1.1.1	Serial/Shareable (5) (7)
LaserWriter Select 310	7.0.1	Serial
LaserWriter 310 GX	1.1.2	Serial (5) (7)
LaserWriter Select 360	7.1.2	Serial, LocalTalk
LaserWriter Select 360	8.3.2	Serial, LocalTalk (6) (8)
LaserWriter Select 360 GX	1.1.2	LocalTalk (5) (7)
LaserWriter Pro 600	7.1.2	Serial, LocalTalk
LaserWriter Pro 600	8.3.2	Serial, LocalTalk (6)

Printer	Driver Version	Cable
LaserWriter Pro 600 GX	1.1.2	Serial, LocalTalk (5) (7)
LaserWriter Pro 630	7.1.2	Serial, LocalTalk, Ethernet
LaserWriter Pro 630	8.3.2	Serial, LocalTalk, Ethernet (6)
LaserWriter Pro 630 GX	1.1.2	Serial, LocalTalk, Ethernet (5) (7)
LaserWriter Pro 810	7.1.2	Serial, LocalTalk, Ethernet
LaserWriter Pro 810	8.3.2	Serial, LocalTalk, Ethernet (6) (8)
LaserWriter Pro 810 GX	1.1.2	Serial, LocalTalk, Ethernet (5) (7)
LaserWriter 4/600 PS	8.3.2	LocalTalk
LaserWriter 4/600 PS GX	1.1.2	LocalTalk (5) (7)
LaserWriter 16/600 PS	8.3.2	Serial, LocalTalk, Ethernet (6) (8)
LaserWriter 16/600 PS GX	1.1.2	Serial, LocalTalk, Ethernet (5) (7)
Color LaserWriter 12/600 PS	8.3.2	Serial, LocalTalk, Ethernet
Color LaserWriter 12/600 PS GX	1.1.2	Serial, LocalTalk, Ethernet (5) (7)

(1) *Optional LocalTalk card installed.*

(2) *Uses GrayShare. GrayShare technology enables printing in 130 shades of gray and connects the printer to a network. Color StyleWriter printers use ColorShare instead of GrayShare.*

(3) *LocalTalk requires Color StyleWriter 2400 LocalTalk Module (M3458LL/A).*

(4) *Some LaserWriters and LaserWriter Plus printers are incompatible with LaserWriter 7.1.2. Use the LaserWriter 7.0 or 8.1.1 driver instead.*

(5) *All GX printer drivers require System 7.5 or greater and QuickDraw GX.*

(6) *LaserWriter 8.3.2 driver update is part of the 7.5.2 Printing Update 1.1.*

(7) *These drivers are updated from 1.0 when you install QuickDraw GX v1.1.2.*

(8) *Use LaserWriter 8.2.2f for optional PostScript Fax Card support and Fax Phone Book features.*

(9) *Use the StyleWriter 1200 driver to print from a Power Macintosh running System 7.5.2 to a StyleWriter I or II.*

(10) *LocalTalk requires LocalTalk Module (M4615ZM/A). EtherTalk requires EtherTalk Adapter (M4775LL/A).*

Printers on the Market

The following sections examine a few of the current market offerings. Because technology and models change fast, contact the companies you're interested in for sample printouts and specifications. Just because a company is mentioned here doesn't mean that it has the best product for your needs; only that it's representative of features and benefits in its respective price range. The Appendix includes a list of manufacturers to contact, including manufacturers for whom there was no room to describe a product.

Inkjets and Hot Wax

The following printers range from black-and-white to CMY with a swappable cartridge for black, to CMYK. They also include hot-wax printers in which wax, rather than ink, is heated and sprayed onto the paper. They're at least as good or better than inkjets, although they do impart a slightly waxy feel to the final output. All printers here are good for basic text and line art, newsletters, and very short print runs. None would be suitable for press checks. For that, move straight up to dye-sublimation.

Apple StyleWriters

Early StyleWriters were plagued with long print times, but the problems are fixed, and the line has remarkably high resolution, up to 720×360 DPI, for little money. They also have one of the smallest footprints, a useful feature if desk space is running short.

Ratings

Color StyleWriter	1	2	3	4	5
Ease of Use					█
Great Features					█
Coolness					█
\$ Value					█
Overall Rating					█

If you bought a Color StyleWriter 2500 early in 1996 and noticed the margins weren't quite what the manual claimed, you're right. The manual lists them incorrectly. They should be as they are in the following table:

There are three models available, 2200, 2400, and 2500. They use a swappable CMY and black cartridge, and for printing on the road, the 2200 is portable and runs on batteries. The StyleWriters don't come with LocalTalk built-in—it costs a little more than \$100 extra. Apple's software does enable thumbnail printing, up to four per page.

Epson Stylus Series

The Stylus Pro is the top of the Epson line. It is a CMYK printer with resolution up to 720×720 DPI (when used with high-gloss paper). It's not a fast machine, rated at three PPM for text and only one PPM for graphics, but that is the price of higher resolution. Epson also makes the less expensive Stylus II, IIs, and a larger B-size printer, the Pro XL. The II and IIs use a swappable CMY and black cartridge, whereas the Stylus II XL uses the same technology as the Pro, a single CMYK cartridge.

Hewlett Packard

The original DeskWriter started out as the original Apple printer, but Apple backed out at the last second, allowing HP to produce one of the most popular inkjet printers on the market, now in many models. The 660C prints up to 600×600 DPI in black-and-white, and, by swapping the black ink cartridge for a CMY cartridge, does color at 600×300 DPI. The 660C also uses HP's image-enhancing technology, giving it a slight advantage in black-and-white. The 855C is faster at 6 PPM rather than 4 (only 1 PPM in color).

Ratings



Margin	Manual	Correction
Left	3mm (0.12 inches)	5mm (0.2 inches)
Right	3mm (0.12 inches)	5mm (0.2 inches)
Top	3mm (0.12 inches)	3mm (0.12 inches)
Bottom	8mm (0.3 inches)	7mm (0.28 inches)

The 1600CM is a heavier-duty version that includes PostScript, Ethernets and is faster. It also automatically switches between PC and Mac printing languages.



Figure 12.1
HP DeskJet 1600CM

Tektronix

The Tektronix 140 is the low end of Tektronix's color printers, outputting 360 DPI and shipping with 8MB of RAM. It also includes LocalTalk and is a true CMYK printer. The 140 is rated at 1 PPM with the standard RAM. Almost, but not quite an inkjet, Tektronix's 300i uses wax, heated and sprayed like ink, and prints on a wide variety of papers. It handles paper up to B-size.

Lasers

These laser printers are representative of the many offerings and give you an idea of features. The amount of RAM a laser printer holds is an indication of how heavy its intended use is. In general, the more RAM it holds, the more likely it's a machine for hard duty.

Apple LaserWriter

Shipping with 2MB of RAM, that can be upgraded to 6, the 4/600 is a 600 DPI, black-and-white printer that's not quite as fast as others in the market. Limited to 4 PPM, it is, however, easy to handle and set up. The 4/600 has no power switch. It shuts off automatically when not in use and comes on when it detects a print job.



Figure 12.2
LaserWriter

Apple's 12/600 PS is a 600 DPI color printer rated at 12 PPM in black-and-white and 3 PPM for color. It ships with 12MB of RAM, that can be upgraded to 40.

GCC

Like its brethren in this price range, the black-and-white Elite prints at 600 DPI. It ships with 4MB of RAM, expandable to 20MB, and prints up to 10 PPM. GCC's XL1208 prints at 1200 DPI on pages up to 12"×20" for full-page spreads, tabloids, and full-page bleeds. GCC has six black-and-white desktop printers as of this writing with a range of speeds and capabilities.

Hewlett Packard

The LaserJet 5MP is a 600 DPI laser printer competing with Apple's LaserWriter Select 360. It only prints 6 PPM, relative to Apple's 10 PPM, but it is quieter. It also uses image-enhancing technology, enabling it to print up to 120 shades of gray, approximately on par with newspaper images. It holds up to 35MB of RAM and has two paper trays. A handy feature is its capability, for about \$200 extra, to convert to a fax machine. It also works in mixed environments, switching from Mac to PC printing languages on-the-fly.

Ratings

HP LaserJet 4MV	1	2	3	4	5
Ease of Use	████████████████████				
Great Features	████████████████████				
Coolness	████████████████████				
\$ Value	████████████████████				
Overall Rating	████████████████████				



Figure 12.3
HP DeskJet 5

The 5M does color, and thanks to image-enhancement, the requisite dithering is handled well. It holds up to 36MB of RAM. HP also offers the CopyJet M, a combination color printer and copier that copies color at 1 PPM, zooms to 400 percent, and has several resolution modes.



Figure 12.4
HP CopyJet M

QMS

QMS has a long line of printers, up to high-speed workgroup printers. Two of its color models are the CX/8 and CX/20. They print black-and-white at 12 PPM (600 DPI) and color between 3 and 6 PPM (300 DPI). The CX/8 ships with 8MB of RAM, and the CX/20 ships with 20MB, both expandable to 64MB.

Tektronix

Combining wax and laser technologies, the Tektronix Phaser 340 has won an award or two for its output. Like an inkjet/wax, it uses heated wax, but it applies that wax to a drum first, and then to the paper, like a laser printer. It prints at 4 PPM in color at 300 DPI, and ships with 8MB of RAM, expandable to 24MB.

Xerox

Xerox makes a lot of printers, and its 4290 is on par with Apple's 12/600. Surprisingly, for a printer of this level, it does not include Ethernet. It does include software that enables the toner, developer, and network connection to be checked over a network. The XPrint also can collate, something few desktop printers can do, and it offers several options for color use, from single color (blueline) to eight colors only to full color output.

The Xerox 510 is a black-and-white printer that can output up to 8 PPM and ships with 6MB of RAM, expandable to 16MB. Xerox driver software includes features not available under the Apple LaserWriter 8, such as banner pages and time stamps.

Thermal-Wax/Dye-Sublimation Combinations

Only a few years ago, this category didn't exist, but it's now a fast-growing market. It's also the best of the graphics arts tools. Although dye-sublimation isn't a prepress check right from the press, it's a good option for relatively low cost and high convenience.

Tektronix

With perhaps the widest range of solutions, Tektronix's offerings include the Phaser 240, 440, and 480X. The 240 is thermal-wax only but has 600×300 DPI resolution and can print on plain paper. The 440 is a dye-sublimation device that prints letter-size, and the 480X goes up to B-size paper for tabloid printing. The 240 ships with 5MB of RAM, expandable to 21MB, whereas the 440 ships with 16MB, expandable to 64MB. The 480X ships with 32MB, expandable to 112MB.

NOTE

While shopping, remember that PPM ratings are only for comparison and depend not only on printer speed but on the printer's size. The Tektronix 480X, for example, is rated for one page every three minutes, but one page is a full tabloid (11"×17").

Fargo

Fargo woke the graphics arts community a few years ago with its low-cost thermal-wax/dye-sublimation printers. The line includes the Pictura 310, 310e, Primera Pro, and the PhotoFun (for casual home users). The Pictura 310 handles paper up to 12"×20" and does not include PostScript, whereas the 310e includes PostScript and color management software.



Figure 12.5
Fargo Pictura 310

The Primera Pro is a low-cost, possibly the lowest cost thermal-wax/dye-sublimation printer on the market, but it still outputs a high-quality dye-sublimation image. It prints on letter (A3) size paper with an optional A6 (4"×5") kit for snapshot-size printouts. Both the Pictura and Primera use the Mac's RAM, which is one reason they're less expensive—the Mac does all the processing.



Figure 12.6
Fargo Primera Pro

Kodak

The Kodak 8650 series are dye-sublimation printers that handle pages up to 9.5"×14". It comes in three models—the 8650, a CMY device; the 8650 PS, which includes PostScript and 32MB of RAM; and an 8650 PS with 48MB of RAM, that can be upgraded to 64MB.

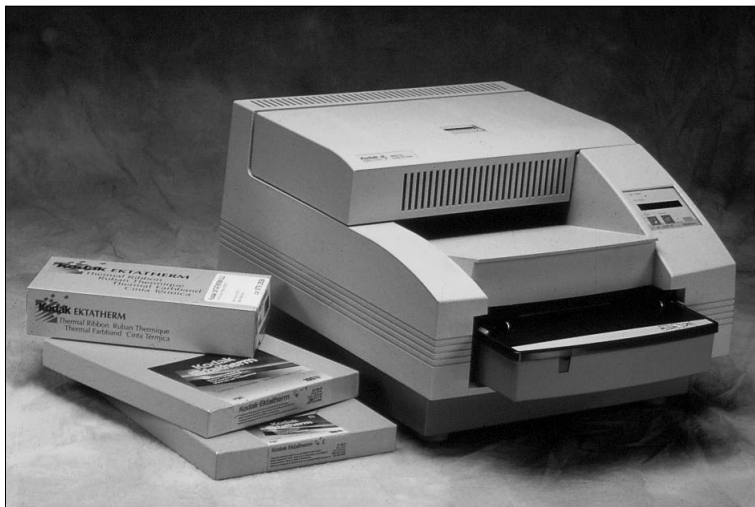

Figure 12.7
Kodak 8650

Seiko

Seiko has several color printers on the market as of this writing, among them the ColorPoint 820 PS, 830 PS, and the 835 PS. They all print at up to 300 DPI. The 835 prints full-bleed tabloid-size pages, and the 820 prints tabloid without a full bleed. The 830 prints letter-size pages only. All have PostScript, room for an external hard drive, and color-matching software.



Figure 12.8
Seiko 835 PS

High-End Color

The following printers are expensive but accurate imagesetters. Although they might not be the most economical desktop printers, they are among the cream of the crop.

Kodak

Kodak's digital proofing system uses dry film and comes with calibration tools that enable it to print at up to 1800 DPI, 200 LPI. It costs more than \$100,000 and is designed for professional output.

Optronics

Optronics has a whole line of imagesetters. Among them are the DeskSetter 3000 and DeskSetter Express. Both print to paper or film, and the Express also prints to plate. They hold media in rolls 13.3" wide for a 12.5"-wide printable area. The 3000 prints at up to 3000 DPI and the Express up to 4000 DPI.



Figure 12.9
DeskSetter Express

Summation

Buying a printer is a long-term investment that can have an immediate impact on your career. Thanks to the new generation of printers, it's possible for a single person to be his or her own graphics shop. Few graphics shops rely on hand-drawn comps or colored pencil mockups for client presentations, and in business presentations, color is practically required. Shop carefully and ask questions copiously before buying.

13

Networking and File Sharing

Early on Apple realized the significance and usefulness of computer networks and included the basic hardware and software in every system. A computer network enables users to share data with ease, either directly or via a central file server. This eliminates, to a large degree, passing diskettes back and forth and generally solves the difficulties of sharing extremely large files. Users also can share single printers, and with the proper software, those working with high-resolution graphics can pool the shared processor resources to reduce the time it takes to render images.

Networking Options

There are several options for Mac networking. LocalTalk is built into every Macintosh, and is the simplest option. It is, however, not as fast as Ethernet. It uses the printer port and AppleTalk system software. Since you can connect the LocalTalk network with inexpensive connectors and ordinary phone cable, it's the lowest cost network solution. LocalTalk supports a maximum of 32 nodes, or devices (Macs, printers, and other peripherals) on the network.

If you want to know...

Go to...

How can I combine my computer's processing power to render graphics?	258
What is Open Transport?	244
How does the Chooser enable networking?	245
How can I restrict guest access to my files?	251
Can Macs and PCs be networked together?	252
How can I share files with my colleagues?	246
What is Ethernet?	244

Ethernet is faster than LocalTalk, and supports both local (LAN) and wide area (WAN) networks. It's commonly used in business and educational applications, because it's versatile and allows Internet connections. It's also more expensive and requires special cabling and special adapters. Ethernet cards have been available for the Macintosh ever since the Mac II was introduced. Many current Mac models have Ethernet capability built-in, and those that don't can add it quite easily. Farallon's EtherWave adapters enable you to connect PowerBooks, slotless Macs, printers, and other peripherals to 10Base-T Ethernet. You can also use EtherWave to create a small hubless network.

Ethernet

When Ethernet was first introduced, it was an expensive way to provide networked computers with far more data-carrying capacity than they needed. But times, and computers, have changed a good deal. Today, Ethernet is acknowledged as the standard. New Macs and Power Macs intended for office use are equipped with Ethernet as well as LocalTalk connectors.

An Ethernet network can support many different protocols at the same time. When AppleTalk protocols run over Ethernet cables, Apple calls the system EtherTalk. EtherTalk networks can handle literally thousands of devices.

Ethernet cables are often connected by network bridges, microwave links, and even satellites to other Ethernet networks to create an extended Ethernet LAN. Many large companies have extensive worldwide Ethernet LANs with thousands of computers.

Because of the increased bandwidth, the throughput of an Ethernet network is higher than that of LocalTalk. Actual transmission rates depend on many factors, such as the amount of network traffic being handled simultaneously, size of the transmitted file, and performance of the individual Ethernet controller and CPU. On average, you can expect an Ethernet network to perform three to five times better than a LocalTalk network.

Several different types of cabling can be used with Ethernet. These include ThickNet, also called Thickwire 10Base-t; ThinNet, which might be called Thinwire 10Base-2; and Twisted Pair or 10Base-T. ThickNet, as the name implies, is a thick wire, about 3/8 inch in diameter.

Apple's most recent networking innovation is called *Open Transport*. It's networking software, accelerated for Power Mac, that combines the control panels and software drivers of AppleTalk, Ethernet, TCP, and LocalTalk, so you can use whichever of these networking systems is available. Among its helpful attributes, it enables you to change your TCP and Internet configuration without restarting your Mac.

Today, most computers are involved in networks, either internally or through a modem providing a connection to the Internet. In addition to the basic tools incorporated into every Mac, many new higher performance hardware and software networking connections are now available, enabling the Mac to perform admirably as a networked personal computer.

Packets

A packet is a sequence of binary data. It has a defined format, with some additional bits of information forming a “head” preceding the data, and a “tail” following it. These carry information that the network router needs to know about the packet, including its destination and source. The packets are formed by the controller in the source computer and the data is extracted and reassembled by the controller in the destination computer. Each one examines the packet address. Only the recipient downloads the entire packet. The rest ignore it. Packet switching networks use routers that direct packets to their destinations.

As network applications grew in size and in power, the speed of Apple’s original LocalTalk networks became a limiting factor in the continuing growth of Macintosh networks. In response to this need developers began delivering products to support connecting Macintosh computers via Ethernet, a faster and more robust networking standard. Initially, Ethernet hardware for the Macintosh could cost over \$1,000/computer, but as demand and volume grew, prices dropped accordingly. Currently, many Macintosh models include built-in support for Ethernet, requiring only a small external transceiver, similar to the one required for LocalTalk. Ethernet networks also require a hub, a central dedicated file server unless you’re using EtherWave adapters.

Chooser

As Macintosh users, we are fortunate to have a very excellent piece of networking software built right in to the Mac OS. The Chooser is one of the least understood parts of the Mac OS, but one of the coolest. With it, a user can find and select network (and local) services in an easy and consistent manner. The Chooser does many interesting things behind the scenes. It dynamically generates a list of available network zones. When you choose a particular service by clicking on an icon, the Chooser then generates a list of those devices that meet the selection criteria. Finally, after you’ve selected a particular service, the Chooser proceeds to discover the AppleTalk address of the chosen service. The names in the Chooser are for your benefit, and the network addresses are for the benefit of the Macintosh.

Each AppleTalk device automatically generates a unique node number, but initially it’s only known by that device. Nodes don’t automatically know the node numbers of other devices. Apple, desiring a plug-and-play environment, decided that the manual creation of node

NOTE

Zones are a way to logically group network nodes. Zones are commonly defined on the basis of physical proximity. All the Macs and Laser Printers and other peripherals on the first floor of a building might be in Zone 1, those on the second floor in Zone 2, and so on. Zone names can be assigned to the network zones. They must be no more than 32 characters long, and they are case-insensitive. The Zone list is a listing of available network zones, commonly displayed in the Chooser. If there’s only one zone, the Chooser doesn’t display a list of zones, only a list of similar devices within the zone.

lists was not in keeping with the spirit of Macintosh. An alternative approach was developed to solve the problem of address determination. This is done by the AppleTalk protocol known as the Name Binding Protocol, or NBP. The process is simple.

When you open the Chooser and click a service icon (such as the LaserWriter icon), the Macintosh first acquires a list of zones from the nearest routers with the Zone Information Protocol (ZIP). It then sends out a NBP Lookup Request packet. (Actually, it doesn't simply send it out, it broadcasts—or multicasts—the request to all devices on the cable. Essentially, the NBP Lookup Request packet contains information on the requested named service. The Object name is the name of the entity that is usually assigned by a person. For a Mac, the object name is defined in the Macintosh Name field of the Sharing Setup control panel. LaserWriter object names are established by the Namer utility program. Examples of object names include: Alfie's Mac, 2nd Floor LaserWriter, and Design File Server.

Of course, multiple LaserWriters can respond to the NBP Lookup Request, and as they do, your Macintosh displays their names in the Chooser. Then, when you select a printer, the Macintosh simply remembers the name of the currently selected printer. This name is then stored in the memory of the Macintosh. This is why, for example, when someone moves their PowerBook from the office network to their home network, the office printer is still selected. To solve this problem, the desired LaserWriter must be reselected from the Chooser.

This NBP request/response conversation happens every time a Macintosh user selects a service from the Chooser. Because the NBP delivery mechanism involves broadcasting (or multicasting), NBP traffic can be a significant part of AppleTalk network traffic.

NOTE

To reduce some network traffic and noise, uncheck the Calculate Folder Sizes in the Views control panel. If this box is left checked, the computer continues to assess folder sizes across the network even after the file server appears on the desktop.

Sharing Files

The most basic way to share files with another Mac user is to use the Personal File Sharing built into Macintosh system software since version 7.0. This combination of control panel and system extension enables you to share your hard drive with other users on your network. This saves a great deal of time and effort in file transfer.

If you do not have a network in place, you can connect two Macs via LocalTalk cables inserted into the printer ports. For anything more sophisticated than this, please consult the *MacWorld Networking Bible, 2nd Edition* by IDG Books.

All Macs running System 7 or higher are capable of peer-to-peer or personal file sharing. Any Mac on a network can become a file server by making one or more files, folders, applications, or an entire drive available to others on the network. Although this approach is effective for one or two machines, it's not recommended for larger groups and not when several people need to use the same application at the same time. At this point, a dedicated file server is a better choice. You dedicate one Mac to act as a file server for the others on the network. AppleShare, which can support as many as 150 users, turns a Mac into a dedicated file server. Current versions are AppleShare 3.0, which can run on any Mac with System 7 and AppleShare 4.0, which can run on any 68040 Mac (except the AV series). The most powerful version, AppleShare Pro, requires a Workgroup Server 95 CPU. You can save a few dollars by not attaching a monitor to the dedicated file server. Such a configuration is known as a "headless" server.

To share files:

- 1 In the File Sharing control panel, start file sharing.

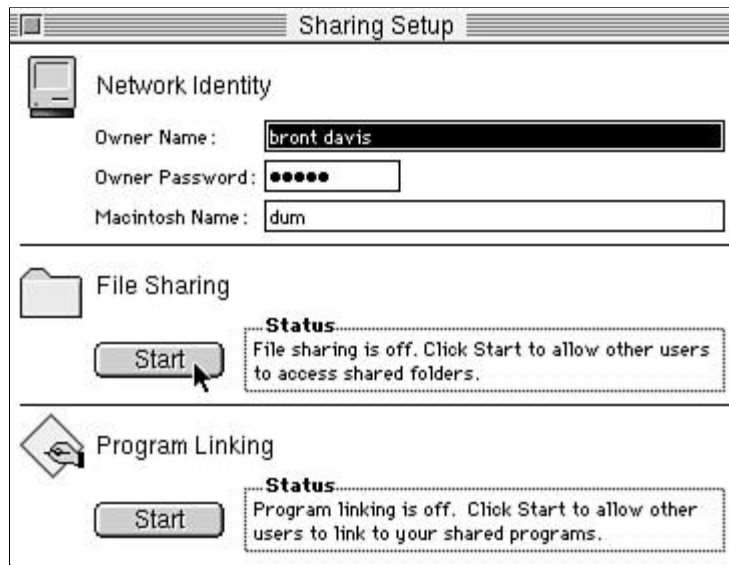

Figure 13.1
File Sharing control panel

- 2 Select (single-click) the disk or file that you want to share.
- 3 Under the File menu, select Sharing.

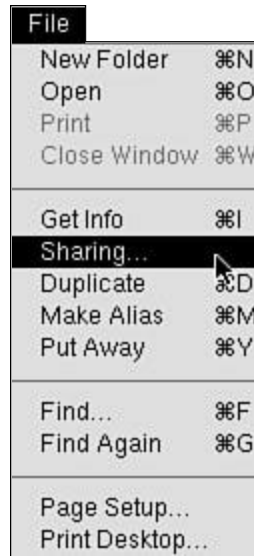

Figure 13.2
Sharing command

- 4 In this dialog box, click the check box that reads: Share this item and its contents.

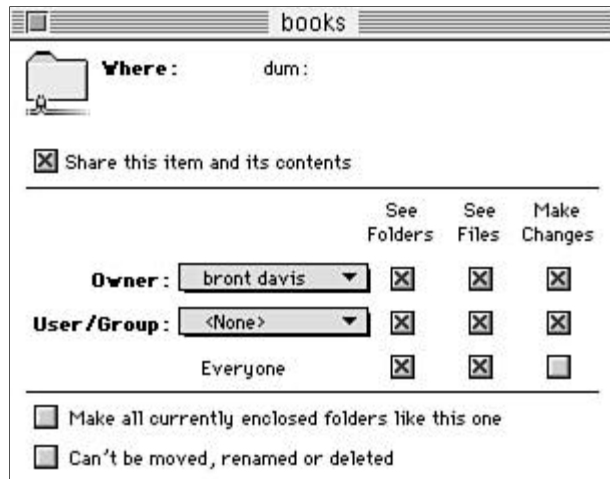

Figure 13.3
Sharing files dialog

- 5 Now your hard drive should appear in the Chooser when users select AppleShare.



Figure 13.4
A networked folder

Creating Users

- 1 Open the Users & Groups control panel and create a new user via the New command in the File menu.
- 2 Name the user and then double-click the New User icon. This will invoke a dialog box as shown in Figure 13.6.
- 3 In this dialog box, you create the user's password. Close and save.

TIP

Don't worry if you can't see your hard drive when you open the Chooser. You can't see it because you already have access. Rest assured that others can see it. If you don't believe me, go next door to your neighbor's machine and have a look.

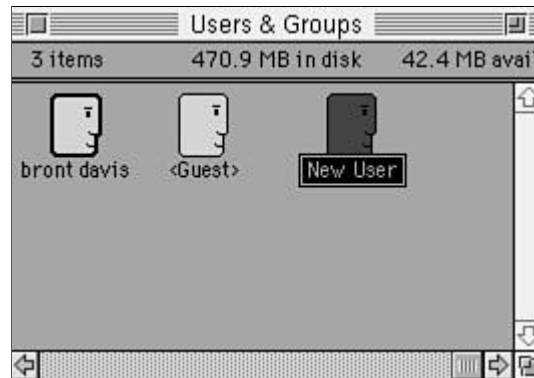

Figure 13.5
New users

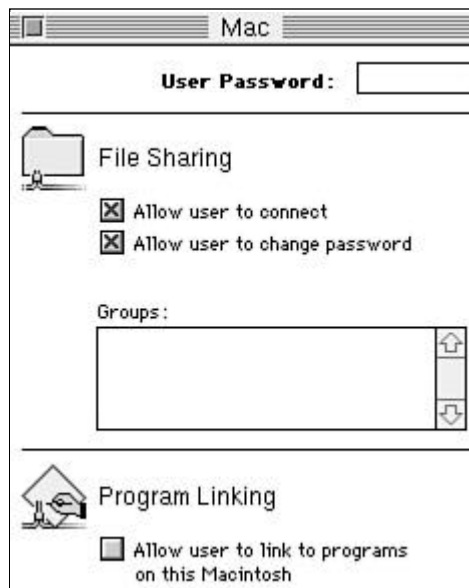

Figure 13.6
Passwords and access

- 4 Now, choose Sharing from the File menu and set up your new user.

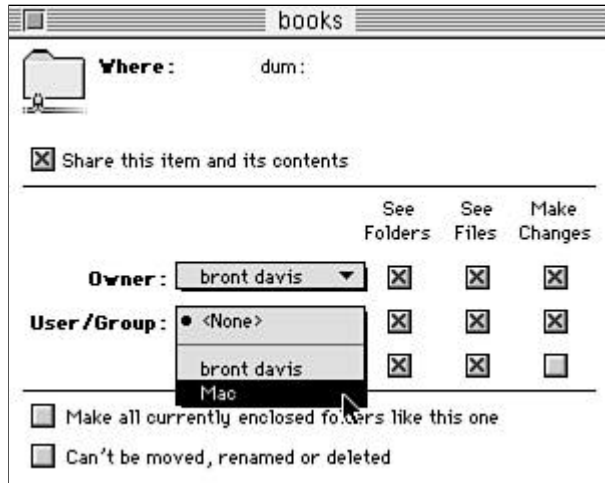

Figure 13.7
Setting up a new user

Creating Groups

- 1 Open the Users & Groups control panel and create a new user via the New command in the File menu.

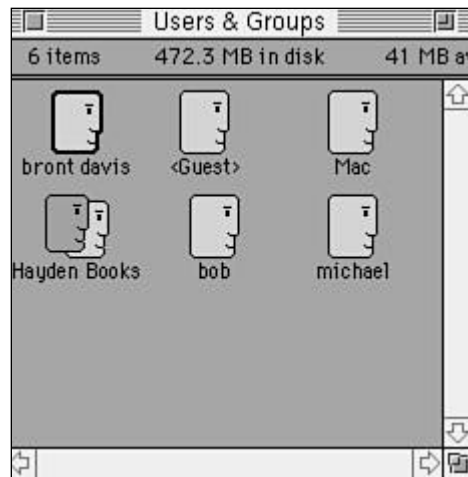

Figure 13.8
Creating a new group

- 2 Drag user icons onto the groups icon.
- 3 Select the folder or disk to which others will have access and then choose Sharing from the File menu.

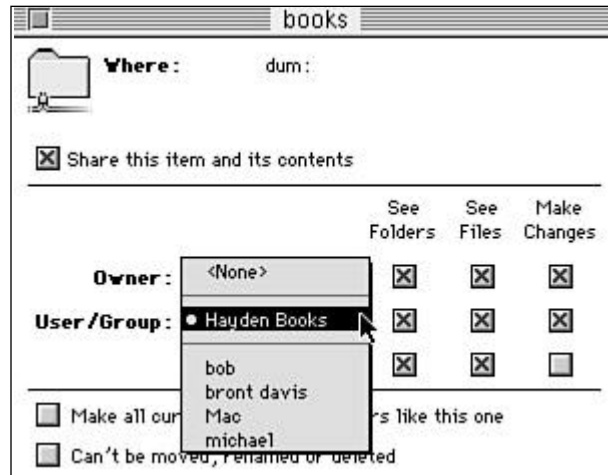

Figure 13.9
Setting up a new group
for file sharing

When sharing files with many people, and when speed is important, it makes sense to dedicate a computer to be a file server and provide it with AppleShare Server software (not to be confused with the Chooser extension AppleShare that provides the capability to connect to any AFP server). AppleShare Server turns the Macintosh into a dedicated file server.

Restricting Access

File sharing can be a wonderful and time-saving device, but it also can be, at best, a venue for pranksters, at worst, well...

The best way to protect your drive is to make absolutely certain that guest access is prohibited. It is asking for trouble. With this enabled, any user on your network simply can click your hard drive in the Chooser and sign on as a guest.

Second, in the File Sharing dialog, you can set up restrictions ranging from none to just seeing folders, to seeing files, to making changes to both.

Be careful who you allow into your hard drive, and when you no longer need to share files, turn off sharing. This also will speed up your machine.

NOTE

If you are, by choice or mandate, administering the file server for your business, and it is your job to give new employees access, let them choose their own password. You don't need to know. Thus, if anything ever happens to their files, you won't be the first to blame. Not paranoia, just a little precaution. Besides, if they forget their password, you can just have them establish a new one.

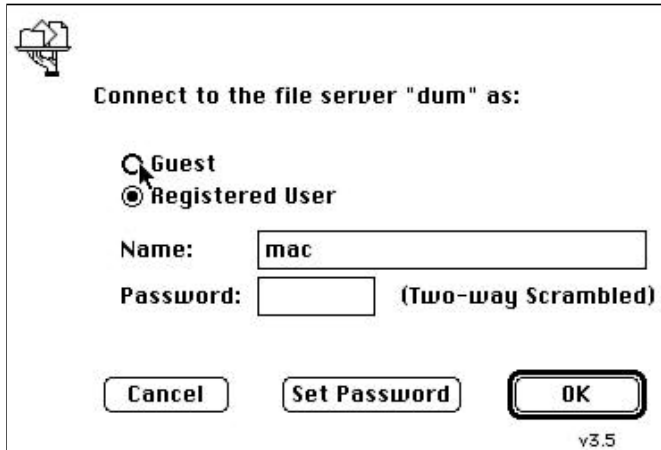

Figure 13.10
Guest access in the Chooser

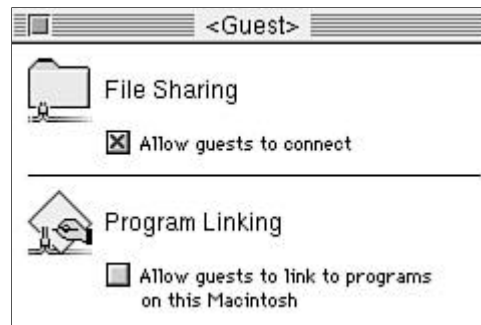

Figure 13.11
Guest access

Macs and PCs

Novell NetWare servers are a frequent choice for Mac/PC connectivity. They enable a PC to be configured as an AFP server so that Macs can access it via AppleTalk. PC users can access the same server via Novell's IPX protocols, letting users share files between the two platforms. NetWare requires an Intel-based PC to run (386, 486, Pentium, and so on), but provides outstanding performance. When a limited number of users are connected to the server at one time, the AppleShare line compares favorably with Novell servers. As the amount of usage goes up, however, the Novell servers show dramatically better performance. Unfortunately, most of the setup and maintenance of NetWare servers must be done from a DOS-based machine.

TCP/IP

TCP/IP is the abbreviation for Transmission Control Protocol / Internet Protocol. TCP/IP is designed to work across a wide range of computer types, all the way from the very biggest to the smallest.

TCP/IP is rapidly becoming part of every Mac's vocabulary, because it's included in System 7.5. Even if you're not tied into a local network with Sun workstations, IBM mainframes, and Cray supercomputers (all of which can talk to the Mac with TCP/IP), you're effectively tied into a Wide Area Network every time you sign on to your Internet Provider.

Servers

Servers are computers that are dedicated to one job. A server can be a high-end machine intended for use *as* a server, or, for less demanding environments, a fast Mac with a big hard drive. Here are some of the options.

File Servers

In networks where multiple Macintosh computers are joined together, certain pieces of software or hardware might be dedicated to the task of managing the distribution of information between individual computers. These computers, called *servers*, are ideally dedicated to each task at hand. Each computer on the network that logs into the server is referred to as a *client*.

Technically speaking, it is the software that makes the central computer a server. So, when not enough equipment is available to dedicate one computer for each server task, a single CPU can serve more than one piece of software, being both a file server and a calendar server, for example. It's customary to refer to the hardware as the server, and the applications it's handling as the server software.

A file server enables users to share files among networked computers. In practice, the file server functions as a single hard drive that is attached to every computer on the network. Thus, other users can access files you save to the server. Because you might not want to share everything you save, file servers usually have carefully controlled access, enabling certain users and groups access to certain folders and files within the server and blocking access to other restricted areas. Servers that are able to provide this service to Macintosh clients are referred to as AFP (AppleTalk Filing Protocol) servers. The actual server can be a Mac, PC, or Unix system, so long as the software supports the AFP protocol. Users might not even know that their server isn't a Mac, because the server's disk drive mounts on the desktop as if it were a Mac.

For better or worse, the computer providing the file server services does not necessarily need to be a Macintosh. Most file servers popular on the Wintel platform, such as Novell NetWare and Windows NT, also support Macintosh clients. If you're a dedicated Mac user, you may want to consider using an Apple Workgroup Server. The current models are essentially PowerPC models with large hard drives (1-2 gigabytes), CD-ROM and DAT drives. Many also include the Apple Internet Server Solution package for the World Wide Web. Most include RAID software for disk mirroring, although the RAID hardware must be purchased separately. The Workgroup Server 95 can also run A/UX system software. Upgrades are available to turn existing Quadra 900s or 950s to Workgroup Server 95 status. These kits must be installed by an Authorized Apple Service Provider and include PDS cards, appropriate software, and in some cases logic board upgrades.

Email Servers

An Electronic Mail server is a specialized type of server designed to handle electronic messages sent between users. Many email servers can handle both interoffice mail and mail sent through the Internet. CE Software's QuickMail, Claris EMailer, and Microsoft Mail are some of the more common applications for interoffice and intra-office mail. They provide both client and server components that work on an AppleTalk network and can also send email through a gateway into the Internet. These email packages enable you to send files as enclosures or attachments to accompany messages, and even let you request a return receipt, so you'll know when your mail has been read. The recipient can save the enclosed file on his or her own disk. This technology goes a long way toward the creation of the near-mythical "paperless office." Memos can be transferred back and forth, as well as graphics files. Larger files can be compressed using a utility, such as StuffIt, before mailing.

Printer Servers

In normal operations, a printer can only handle one print job at a time. Thus, when several people try to print to the same networked printer, each has to wait for the previous person's print session to end before his can begin. A print server provides a more intelligent method of capturing each print job. As each user attempts to print, the print server collects the print job that would otherwise be sent to the printer and holds it in memory. As the jobs come in, it queues them, sending them to the printer one after another. It is similar to the Mac's built-in print spooler, PrintMonitor, except that being an external device, it doesn't interfere with the individual computer's operations at all. It doesn't tie up their RAM and doesn't slow down other processing, as an internal print spooler can.

The number of fonts built into a laser printer only matters if you use those fonts often. Graphics designers and illustrators generally use a wide range of nonstandard fonts, so having Palatino, Times, Courier, and so on built in really doesn't help. If you need fast output and want lots of fonts immediately available, look into a printer with a built-in hard drive. The fonts are loaded on the drive, so that they need not be sent to the printer each time, which cuts network traffic as well as print time.

Remote Access Servers

Remote access servers provide the capability to connect to the network from remote locations through the use of modems or other wide-area communications hardware, which is great for submitting work or accessing forgotten files while traveling. Generally, these units consist of a specialized piece of hardware dedicated to the task. These devices are not computers, or even servers, but boxes to which you can connect modems and networks. One can also set up a Macintosh to be a remote access server with Apple's Apple Remote Access software or Apple's Multiport Remote Access Server hardware. The client computer makes use of Apple's Apple Remote Access (ARA) client software to connect to the remote access server. The Multiport server is a card that you put into a Mac, and then attach modems. It enables the Mac to communicate with several remote clients at once, each over a separate modem and phone line.

Modem Servers

Much in the way that a fax server shares a fax modem between people in a network, a modem server shares the data transfer functions of a modem with each user. Each time a user needs to make an outgoing data call, the modem server forms a virtual connection to that computer, simulating a directly attached modem. This can result in large cost savings, because only a few modems and telephone lines can be effectively shared within a large office.

On the upswing, I, a sometime technophobe, have come to find the advancing methods of communicating and transporting info via a modem to be uplifting. It enables me to be more flexible with whom I work for and the kind of projects I can take on. With my recent relocation to the Southwest I have been able to find solace in staying connected to my friends in the East while keeping the phone bill in check.

Stephanie Peters, AIGA
Scottsdale, AZ

Network Topologies

The method by which a computer network is physically laid out is known as the network topology. The various network topologies are technically independent of data links and transmission media, but each transmission medium only supports specific topologies in specific fashions.

Bus Topology

The Bus is the simplest type of network, and the type network Mac users are most familiar with as it is used for LocalTalk/PhoneNet networks. It consists of computers “chained” together with wires starting on one computer, meeting the next, and so on until the end. This configuration is also frequently called the “daisy-chain.”

The Bus topology is used with LocalTalk, in both Locking LocalTalk (Shielded Twisted Pair) and PhoneNet (Unshielded Twisted Pair) configurations. In addition, thin Ethernet (Thinnet) makes use of this topology.

The advantage of the Bus topology is ease of setup. Because each computer simply connects to the next, cabling is fairly straightforward, particularly in a room with multiple computers (such as a computer lab). The primary disadvantage of this type of setup is that, much like a string of Christmas lights, if the chain is broken at any point, every computer on the network is disconnected. In addition, it is very difficult to locate cabling faults without physically going from station to station.

Overall, Bus topologies are very practical only with a small number of computers, or when most of the computers are concentrated in a single area. Beyond this, the difficulty in maintaining and troubleshooting this type of installation makes a Star topology preferable.

STAR Configuration

The alternative to the Bus topology is the STAR configuration. In this type of setup, each computer is connected by a network cable to a single central location. This topology can be more expensive to install, because each computer must have a wire running all the way back to the center of the network, as opposed to the Bus network where each cable need only run to the next closest workstation.

The primary advantages of this topology are in the areas of manageability. Because each workstation has a dedicated cable to a central location, problems on any single cable are isolated to that workstation.

There are two types of star networks: passive star and active star. The active star network uses a device known as a hub to act as a central manager for all data traffic. The passive star takes the cabling schema of the active star but works without the central hub by simply cross-connecting each workstation’s cabling.

Wireless Networks

As computers get smaller and smaller, the cabling systems that used to connect them also tie them down to the desktop. The solution is to eliminate the cabling. Wireless networks are a recent development that does just that. There are several wireless technologies available for the Macintosh.

One option for a wireless network is to use Apple's Remote Access with a cellular phone/modem combination. This makes sense for wide area network connections for a limited number of devices. This enables you to retrieve files from your home office and stay in touch with clients while traveling.

Ratings

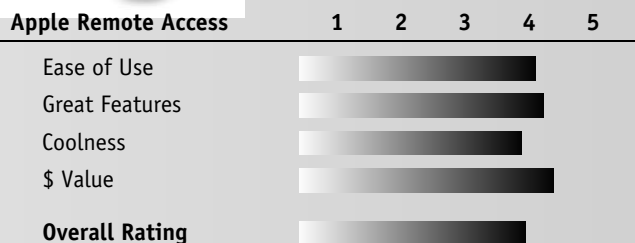

For LAN connectivity, wireless technology can be useful in locations where conventional wiring is difficult or impossible to run. Motorola, the leading manufacturer of cellular telephones, has a Macintosh product called EMBARC that provides a one-way wireless messaging service for remote Mac users. There are also options for LAN mediums, such as LocalTalk and Ethernet. Photonics makes LocalTalk devices that use reflected infrared to link a number of nodes. The infrared devices focus their energy at a single point on the ceiling.

Ratings

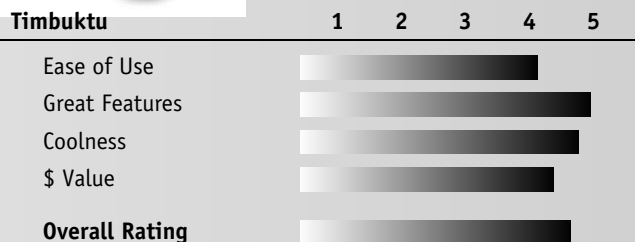

continues

continued

Motorola has developed a wireless version of Ethernet, the Altair II wireless network. These devices use low-power radio waves as a transmission medium. Altair's transmission rate of 5.7 Mbps is somewhat less than Ethernet bandwidth, but adequate. Setup is easy. Each Ethernet device connects to a small desktop send/receive module. These desktop modules transmit radio waves to control modules that connect to walls or cubicle partitions. The send/receive modules support all kinds of Ethernet adapters and cost around \$1,200. The control module can be used alone or connected to a conventional Ethernet cable. These devices can handle up to 50 wireless devices.

Compared to conventional wired networks, these new technologies are still somewhat expensive and are only cost-effective in those cases where wiring is difficult or where rewiring costs would exceed the cost of the wireless components. Expect wireless communications to continue to increase in popularity as Apple's Newton technology and other handheld computers become more popular.

Network Rendering

Networks also can pool the resources of several computers to render highly detailed 3D scenes or animation. This is sometimes referred to as a *rendering farm*. Several software packages support network rendering, including Specular Infini-D (using an add-on package called BackBurner) and Hash's Animation Master.

Network rendering requires a central control program running on one computer and processing programs that run on other computers on the network. The central program takes a 3D scene and delegates the scene information (including models and texture information) to the processing programs. Each program is assigned to render one part of the image—the image usually is divided into a grid of squares—and the central program receives the rendered parts and assembles them.

One advantage of this process is that the processing programs operate in the background and can be configured so that they work only during certain times. Correctly configuring them eliminates any performance degradation.

The more computers available, the faster each image is rendered. There are trade-offs, however. The network's speed and the size of the models will impact performance. If the rendering process is running over a LocalTalk network, it may take so long to send the data back and forth that performance improvements are negated except for small jobs. Also, it is not worth adding significantly slower computers to the rendering farm. As an extreme example, if you had a PowerPC 604-based Power Mac and a slower 68020-based Macintosh II, it would make no sense to network them together. The rendering time contribution of the Macintosh II would be insignificant when compared to the performance of the Power Mac.

14

Using The Internet

Itake it for granted that you've heard about the Internet. There are hundreds of books about the Net, and it seems to be covered daily in newspapers, magazines, and on television. It's difficult to predict how long Netmania and widespread popular use of the Internet will continue, but it's safe to say that in the mid-90s, the Internet is a very hot topic.

What Is the Internet?

Before we move on, let's take a moment to talk about what the Internet really *is*. Many creative professionals' workplaces use some sort of network—perhaps you share your Mac's files with co-workers, or use a file server to store current projects and archives. In the simplest and most accurate sense, the Internet is just a big network with millions of machines networked together.

If you want to know... Go to...

How can I transfer files over the Internet?	286
How do I create a Web page?	278
How do I navigate the Web with Netscape Navigator?	267
What are plug-ins?	270
Is there a drag and drop Web page creation application?	280
Can I change my existing documents into a Web format?	282
How can I register my Web pages?	282
How do I search the Internet?	271
What are the best modems?	265
What is Usenet?	261

There are a few special features about this network we call the Internet. Most important, it's hooked together with a Unix-based networking protocol called TCP/IP. Many of the individual networks that make up the network might use other protocols (like AppleTalk) to communicate internally, but TCP/IP is the glue that holds everything together.

Also, the structure of the Net and the nature of TCP/IP make the Internet a very reliable (or, as computer scientists say, *robust*) channel of communications. The Internet was designed by the military to survive a nuclear war, so it can easily withstand problems like crashed servers and the Communications Decency Act.

What is an Intranet?

Lately, you've probably heard the term "Intranet" as often as "Internet." What's the relationship? Like the Internet, an Intranet is a big network of networks that uses TCP/IP to link networks and machines together. Intranets, however, are privately owned—unlike the Internet, which is a consortium of public and private networks and machines. There's only one Internet, and an ever-increasing number of Intranets.

What is the Web?

The World Wide Web brings a fresh, new graphical user interface to the Net. You might think of it as analogous to the Mac's desktop-and-folders system, which provides a visual way to organize the files on your own machine. The Web is a system that visually organizes the information shared over the Internet.

The Web enables you to find documents (called Web pages or home pages) on the Net that contain a variety of formats, anything from text to photos and graphics to audio and even video. At one time, the Net was all black-and-white, navigable only by textual landmarks. To look at a picture, for example, you would have to guess from a file's title (invariably something like "MyBB.bmp") that it was a picture that you might be interested in, download the picture sight-unseen, and hope that you could open it with Photoshop. To read a text document, you downloaded it and read it with your preferred word processor. If the text file referred to another document that sounded interesting, you would manually locate and download the new document for reading.

The Web has transformed the Net into a colorful universe, with pictures, text, and even movies and sounds that load in the browser's window automatically. And Web browsers give you the capability to jump seamlessly from one document to another on servers anywhere in the world by providing clickable links attached to documents' pictures and texts.

What is Usenet?

If you follow coverage of Net issues at all, you might have heard about Usenet. What is it? Basically, it's a network-based forum to discuss any—and we do mean *any*—subject you can imagine. Sometimes, Usenet seems like a great way to communicate with your peers and find answers to technical questions. Sometimes Usenet seems like an endless transcript of an argumentative talk-radio show about Star Trek. Sometimes, Usenet seems like a complete waste of time. You'll have to decide for yourself how well it suits your particular needs.

Here's how it works: let's say you'd like to know if there's a Quark Xtension that opens PageMaker files, and you haven't found any information anywhere else on this issue. You would write a brief message explaining the problem, and using news-savvy software like Netscape Navigator, post it to newsgroups that discuss PageMaker and Quark. Your local *news server* takes your message and passes it along to the other news servers in the giant chain o' Usenet. Other users can read your message, and sooner or later, someone will probably post a reply. The reply circulates through Usenet, and eventually appears on your local server, where you can read it. You can read other users' messages and replies as well. Of course, you need never post your own message to pick up useful information about Usenet.

The great thing about Usenet is that someone will usually reply to your post—very often, on the same day that you post the message, a solution to your problem will appear. The frustrating thing about Usenet is that the reply can often be hostile (for example, “The answer is easy to find! Don't post stupid questions like this!” or “Why would you ever want to convert from Quark to PageMaker?!”), wrong (“I think PageMaker can just open Quark files, right?”), or just plain useless (“This reminds me of the time that Captain Picard...”).

Newsgroups cover just about any subject you can imagine: politics, religion, computers, and so forth. As of this writing, there are at least 10,000 newsgroups, and this number is increasing daily.

Ratings

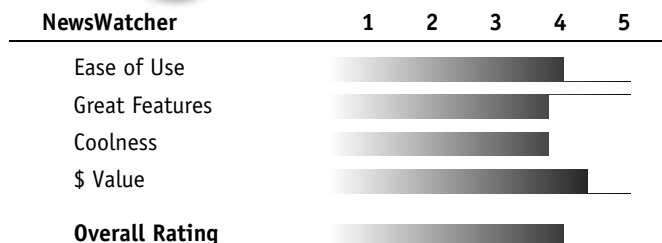

Newsgroups are organized into hierarchies. The following contains the seven basic subjects that newsgroups are organized by.

Keyword	Description
comp	Newsgroups for the computer professional
news	News online (Clarinet is a big name in News)
rec	Recreational newsgroups
sci	Newsgroups catering to science issues
soc	Social issues
talk	Discussion newsgroups
misc	Other subjects

In addition to these seven basic subjects, there is an *alt* hierarchy. A great deal of study and approval processes is required for a newsgroup to join the seven majors, but an alt newsgroup can be set up by simply making a trip to your local service provider. For this reason, alt newsgroups tend to be more free-form (for example, alt.imploding.kibo) and not all alt groups are carried by all news servers. This is not to say that an alt newsgroup can't be as serious as others. In fact, some newsgroups get their start in the alt section and move into the appropriate major hierarchy when it has gained the acceptance of the newsgroup community.

Each newsgroup is named in accordance with a general subject first and the most specific subject last. If you're a Mac creative professional, you're probably interested in groups like comp.sys.mac.hardware, comp.text.desktop, or comp.publish.prepress.

If you're new to newsgroups and want to give them a try, you can start by subscribing to the news.announce.newusers group. To do so, however, you'll first have to get newsreader software to access and read newsgroups, and ask your Internet service provider for the address of your news (also called an NNTP) server. (If your Internet access is through a commercial service, such as AOL, you might be able to read news without any special software.) Commonly used Mac newsreaders include Nuntius, Newswatcher, and Netscape Navigator.

Ratings

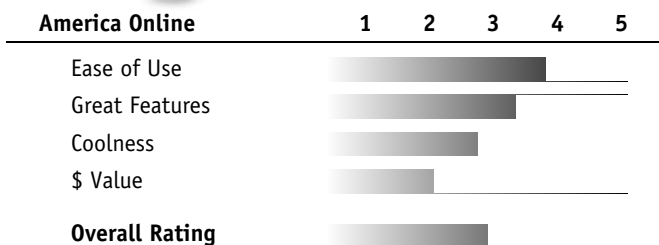

Every newsreader works a little differently, but after you've learned how to find the newsgroup you're looking for, you're all set. Every newsreader needs to know your NNTP address—often, the software will ask you for the address the first time you launch the application, or you can set it in the program's preferences. See your newsreader's Read Me file for particulars.

You can't post to the news.announce.newusers group, but you'll find it helpful to read its postings—written questions and responses from visitors concerning how to use Usenet.

How to Surf the Net

Your organization may already have a connection to the Internet. If you work for a college or university, for example, and you're connected to the campus network, you're probably already hooked up to the Internet, and it's probably a great connection.

The first step, then, is to consult with your organization's network specialist. Your network specialist can give you all the software and information you need, and fill you in on any policies your organization may have regarding publishing personal information on the Net, downloading software, and similar issues.

If your organization doesn't have a connection, or if you're exploring the Internet on your own, you need to establish a connection to the Net. Specifically, you need:

- Hardware**—You need something to physically network your machine(s) to a machine that's connected to the Internet. If you're working with a single machine, like a home computer, you'll probably use a modem. If you have a local network, you'll probably need specialized hardware like routers—it's probably best to contact a consultant (or whoever set up your network) for advice.
- An Internet Service Provider**—An Internet Service Provider (or ISP, quickly becoming the Service Bureaus of the 90s) provides a fast, wide connection to the Internet. By networking with the ISP's machine, you connect your machines to the Internet.
- Software**—You'll need some basic software to get connected.

Hardware

The hardware required to connect your machine to the network can range from an inexpensive modem to a dedicated line that can cost thousands of dollars a month. The main difference between setups is *bandwidth*—how much information can carry, and at what speed.

Bandwidth can probably best be illustrated by considering how a water pipe works. A large pipe has the potential to carry a lot more water than a small pipe. Similarly, a high-bandwidth line has the potential to carry lots

of information. If you choose a low-bandwidth connection, your data will arrive much more slowly.

Bandwidth isn't going to mean much to you if you don't know how to measure it. In the water pipe example, you have water flowing through at a certain rate, and the flow of water is usually measured in gallons per minute (gpm). Bandwidth is measured in bits per second (bps). Now, let's translate that into real world numbers. A high-density diskette holds 1.44MB of data. Say you want to transfer your data over the phone lines, and let's assume for this example that you have a variety of modems at your disposal. The following table illustrates the amount of time it takes to transfer the contents of one diskette at several different transfer rates.

Transfer rate (in bps)	Seconds	Minutes	Hours
9600	1200	20	0.33
14400	800	13.33	0.22
28800	400	6.66	0.11
57600	200	3.33	.05
128000	90	1.5	.02
256000	45	.75	.01
512000	22.5	.37	very small
1024000	11.25	.18	very, very small

Modems that can communicate over standard phone lines with no additional hardware can now operate as fast as 28,800 bps, and with compression, can achieve bursts of data-transfer that approach 57,600. (This is about the limit of what conventional phone lines will carry—modems won't get much faster than this.) I've also included entries for some more exotic hardware connections, such as Fractional T1, ISDN, Frame Relay, T1, and T3.

It's easy to set up a modem-based connection by yourself, and most service providers are geared toward modem-based services. If this Net stuff is new to you, you'll almost certainly want to start with a modem, and explore other options as your needs grow.

When you are ready for a high-end connection, contact your ISP and your phone company. Setting up an ISDN or T1-type connection is a complicated mess, and the procedures vary greatly according to your location and circumstances. (A great introduction to the subject of Internet hardware can be found in Stewart Buskirk's *Web Server Construction Kit* published by Hayden Books.)

NOTE

Keep in mind that these transfer rates assume that there's no overhead for network information (and there is), and that there's only one file being transferred on the network. In the real world, there's plenty of traffic, and most of a giant pipe is spent handling hundreds or even thousands of transfers at once, rather than sending tiny files in microseconds.

Choosing a Modem

When computing began, 300 baud was a fast modem. Then the 2400s came out and we thought we were in heaven. Now 28.8 (28,800) baud is the standard and isn't nearly fast enough, giving rise to ISDN and speeds of 56KB and 128KB. As you're shopping for a modem for Internet access (or any other purpose), go straight to the 28.8s. There's really no reason to use a 14.4 anymore. If your ISP charges by the hour, the money saved quickly will be lost in waiting for Web pages to load and files to transfer.

What modems do is take the digital information from your Mac, turn it into analog, then turn it back into digital on the other end. *Modem* stands for modulator-demodulator.

Modems are hotbeds of oddball terms—v.21, v.32, v.FC, V.FAST—most of which you don't need to worry about. If you find a modem with v.34, you're fine. It contains all the required protocols rolled into one (as of this writing). The protocol V.FAST predates v.34 by a few months, and a few manufacturers may try to sell them as the same as a v.34. Go with the real v.34.

Hardware

A common misconception in the modem world is that there are Mac modems and PC modems. Not so. A modem is a modem is a modem. The only difference is bundled software and cable, so if you see a bargain on a PC modem and can add another \$10 to \$15 for the right cable, go ahead and buy it. There are, however, few internal modems for desktop Macs, and the Mac isn't very adept at finding them when installed. External modems work much better with desktop Macs.

The cable *does* matter. It should be more than a generic modem cable—look for one labeled “hardware handshaking.” A hardware handshaking cable does some of the modem's work, and that speeds transfers.

In the modem itself, look for informative displays. Some Supras have an LED text display on the front that displays connect speed, error correction, and a few other details. If you're downloading a big file that seems to be going too slow, you can check the modem to see how fast it's connecting. A 28.8 modem that's running at 2400 baud is not doing all it could do, and the problem could be one of several things. There might be line noise, the software might be set too slow, or the host on the other end may have a slow modem. Your modem can tell you how fast you're connecting regardless of how the connection was made.

The modem's case can make a difference too. Cheap plastic cases are a sign of inexpensive workmanship and might fail more often. The return rate on Zoom modems is higher than on Supras. The Zoom is made of cheap plastic and the Supra is made of aluminum. This isn't to say you can't find a bargain, only that you're more likely to ship it back for a replacement. Global Village is an exception—they use a lightweight plastic case but have a very high-quality product.

A truly convenient feature is a front-mounted on/off switch. If a connection has become a problem or the software's hung and the modem needs to be reset, it's far easier to reach out, power the modem off and on again than to unplug it or reach around the back. A quick power cycle can fix a lot of problems.

continues

continued

Apple's Geoport

Slow in taking off, the Geoport is now a more viable option. It has the additional advantage of telephony features, enabling you to handle, with the right software, telephone calls through your Mac. It also can fax as well as handle voice mail and 28.8 modem connections.

Faxing

Most 28.8 modems can send a fax right from the machine, in effect, printing to a fax machine. Hitting ⌘-P with a modifier key prints a page a thousand miles away. It also prints cleaner than a standard fax machine. The page doesn't have to be converted from paper to electronic form first; it just prints at fax resolution (about 200 DPI). Even if you already have a fax machine, a fax modem and its software is worth the extra effort. Without it, faxing means printing and then faxing the printed page, which means taking digital data (the computer file), making it into analog (on paper), then making it digital again (through the fax), and then analog again (at the other end of the fax). Why not print straight to the fax machine?

Price Range

What seems to be the same device can cost a wide range of prices. A Cardinal modem, for example, is less than \$150 at many discount stores, whereas the Global Village Platinum can be nearly \$300. Why? In part, bundled software. If you're buying a modem for the first time and don't have modem or fax software, the extra money may be well spent. Another reason for the cost difference is support. Global Village is renowned for its modem and fax software, and their customer support is excellent. Cardinal, on the other hand, ships with rudimentary software (for Windows) and not as much support.

Perhaps the best deal to be had is by mail-order companies, such as ClubMac and MacMall. See the Appendix for a listing of modem manufacturers.

For more technical information, point your Web browser to <http://www-ccs.uchicago.edu/technotes/Modems.html>.

Choosing an ISP

The ISP industry is still relatively new, and you'll find that prices and services vary greatly, even with a single market, and things can change very quickly. I've compiled some basic issues that are fairly universal and recommend that you ask questions like these when you're considering prospective ISPs.

- 1 Can the ISP accommodate your needs as you grow? If, for example, you decide to upgrade to an ISDN service later, is the ISP wired to receive the connection?
- 2 How is the service billed? Is there an hourly charge, or a flat rate for the month? Some services even charge by the amount of information transferred—by the byte.
- 3 Exactly what services does the ISP offer? Most ISPs provide email and SLIP or PPP services that enable you to use a Web client. Many

but not all, ISPs provide an NNTP server that enables you to read Usenet news.

- 4 If you want to serve Web pages through your ISP, will the files reside on your machine, or on the ISP's server? If the files are on the server machine, what's the limit on the total size of all the files. Can you freely access your own files on the server? Does the ISP allow CGIs (Common Gateway Interfaces that enable you to create process forms and other special effects) on the server?

Configuring the TCP/IP and SLIP/PPP Software

With any luck, your tech person or Internet Service Provider will hand you a magic disk that installs all the TCP/IP and dial-up software you need, and with one double-click, everything will install and configure itself. (If you're really lucky, your tech person will install it while you're at lunch.) This is a good time to feel smug about using a Mac, or to call up and taunt your Windows-using friends.

If you're using a modem to dial up from home, and your ISP hasn't provided you with one of those magic disks, you'll need to get specific instructions on how to configure your machine. (If your ISP can't help you at all, maybe it's time to find a new provider.) If you don't have System 7.5, you might need to dig up some software as well. One convenient source for all the software you need *and* detailed instructions for configuring your Mac, is Adam Engst's *Internet Starter Kit* by Hayden Books.

Using Netscape Navigator

Let's take a quick look at basic Web surfing using Netscape Navigator. Naturally, the most complete source of information about Navigator on the Mac is, *Mastering Netscape 2.0 for Macintosh* (Hayden Books) by Greg Holden and Tim Webster (your humble narrator).

By default, Netscape Navigator loads Netscape, Inc.'s home page. If you've found an URL somewhere—in a magazine, newspaper, on television, tattooed on someone's arm, or wherever, you can load the URL by choosing Load from the File menu (⌘-L) and typing the URL into the Load URL dialog box.

Ratings

Netscape Navigator	1	2	3	4	5
Ease of Use					
Great Features					
Coolness					
\$ Value					
Overall Rating					

National and Regional Access Providers

The mid-'90s finds the world in the midst of the great Internet shakeout, with no single Internet access provider currently claiming more than a small percentage of the market. And in the meantime, considerable demand is driving Internet access toward a billion-dollar business, creating a few dominant national access providers and thousands of smaller local access providers that make the Net accessible from nearly every major city in the country.

Unlike their cousins, the commercial online services, companies providing true nationwide Internet access are more numerous. And to a large extent, as the user you select whatever services you need in choosing a particular national or regional access provider. You're not limited to which Internet services you can use or which software you can use to access them. Each service provider has a slightly different offer directed by a somewhat different business strategy, but overall it's a better deal than a commercial online service can provide. The following table provides a brief list of national and regional ISPs.

East

Agate Internet Services	207-947-8248
BBN Internet Services	617-873-8730
Capcon Library Networks	202-331-5771
Clark Internet Services	410-995-0691
Digital Express Group	301-220-2020
Echo Communication	212-255-3839
FishNet	610-337-9994
MV Communications	603-429-2223
PSI Net Pipeline	212-267-3636

South

The Black Box	713-480-2685
CyberGate	305-428-4283
Global Access Vnet	704-334-3282
Internet Atlanta	404-410-9000
Nuance Network Services	205-533-4296
RealTime Communications	512-451-0046
Telelink	615-321-9100
Texas Metronet	214-705-2900

Midwest

CICNet BBB	313-998-6703
InterAccess	800-967-1580
Macro Computer Solutions	312-248-8649
Msen	313-998-4562

Prairienet Freenet of East Central Illinois	217-244-1962
StarNet Communications	612-941-9177
XNet Information Services	708-983-6064

West

Colorado SuperNet	303-273-3471
CTS Network Services	619-637-3637
Eskimo North	206-367-7457
Hawaii OnLine	808-533-6981
Internet Direct	602-274-0100
Portal Communications	408-973-9111
Teleport	503-223-4245
West Coast Online	707-586-3060

National

HoloNet	510-704-0160
Internet Express	800-592-1240
John von Neumann Computer Network	800-358-4437
Netcom Online Communications Services	800-501-8649
Performance Systems International (PSI)	800-827-7482

Canada

HookUp Communications	905-847-8000
UUNET Canada	416-68-6621
UUNorth	416-225-8649

These are but a few of many options available from national and regional Internet access providers. Before signing up, however, you may want to undertake a more thorough evaluation of Internet access providers.

In addition to commercial online services and national and regional Internet access providers, there also exist a large number of community-based services providing access to the Internet. Local access providers offer the same full Internet services as national or regional providers, yet provide packaged information in a somewhat more targeted fashion to better meet the needs of their community. Local providers usually offer services only within their local area code.

Basic Navigation with Netscape Navigator is very intuitive. There are two basic steps:

- 1 **Point**—Links are usually signified by bolded, underlined, colored text, or by an image with a colored border, buttons, or by words like “click in the map below.” Put the mouse cursor over the link.
- 2 **Click**—Navigator loads the new page to which the link pointed.

Even a designer can figure it out! (Art directors and vice presidents may still need a little help.)

Navigator keeps a record of all the sites that you visit in a surfing session, and you can easily backtrack (within the current session) by clicking the Back button in the top left corner of the Navigator window.

If you find a page interesting, you can bookmark it with the Add Bookmark (⌘-D) command. After you bookmark a site, its name is added to the Bookmark menu. To return to the site, simply choose it from the menu.

TIP

It's very simple to download pictures from the Web if you're using Netscape Navigator and you have the Macintosh drag-and-drop system extension (which comes free with System 7.5 and with Netscape). Just drag the picture from the Navigator window onto your desktop...that's it! You can open the file with Photoshop or any pixel-based image editing software that can handle GIF and JPEG files. (We'll talk about these file formats in detail later in this chapter.)

Plug-ins

The folks at Netscape don't call Navigator a browser anymore—they call Navigator a “platform,” in the same way that we call the Mac or Windows “platforms.” What this means is that developers can write software for Navigator that runs inside the Navigator window so that Navigator can do new and exciting things that the Netscape engineers didn't write into Navigator itself.

What this amounts to in practical terms is *plug-ins*. Navigator plug-ins are very much like Adobe Photoshop plug-ins...you throw 'em into Netscape's plug-ins folder, and suddenly Navigator can do new things. Most of the plug-ins that have been developed thus far enable browsers to read special file formats embedded in Web pages—like QuickTime movies, Macromedia Director presentations, and Adobe Acrobat PDF files.

Ratings

RealAudio	1	2	3	4	5
Ease of Use					
Great Features					
Coolness					
\$ Value					
Overall Rating					

Just about every Web page that requires a plug-in has some sort of notice (“This page best viewed with the Shockwave plug-in installed”). Most pages also provide a link to a site where you can download the plug-in.

Ratings

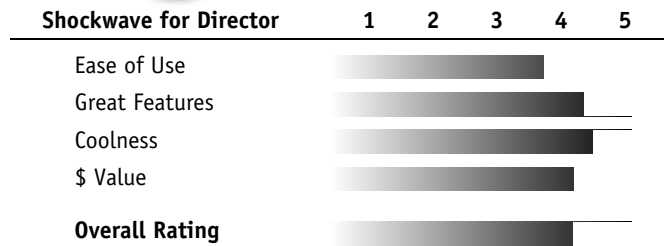

Search Engines and Tools

Because the Web is the most popular way to publish information on the Net, it makes sense to search the Web first; however, since the Web is loosely structured and growing exponentially, it’s difficult for automated searching to take place at all—you can’t possibly search every site on the Web every time you want to find something.

There are two main ways to look for information on the Web: consult a catalog or directory organized by subject, or use a search engine.

The most popular catalog right now is Yahoo (see “At a Glance” at the end of the chapter). Yahoo is a sort of free “Internet Yellow Pages.” It is an index organized by subject, cataloging other Web pages. Yahoo lists many resources. Click what you’re interested in, and you’re instantly transported to that site. Because of the dedication of its creators, its listings change regularly.

The advantage to using catalogs is that they, at least in theory, contain only sites that are large (or unique) enough to merit listing. Because everything is organized by subject, a site that contains information on a particular subject can be found very quickly.

The disadvantage is that perhaps the bit of information you want is out there, but it hasn’t been cataloged, so it’s not in the index yet. This is becoming less and less a problem as the catalogs become larger, but the problem will never disappear. That’s why it’s often wise to check more than one catalog.

Search engines are another powerful tool for searching the Net. Search engines use software robots to compile huge databases of information about every Web page they can find, and you can search these databases using keywords that you supply. Search engines contain information about small sites—like personal home pages—that catalogs can’t include.

One of the best search engines is Lycos, run by Carnegie Mellon University. It continuously traverses the Web looking for new documents. Lycos is able to catalog about 5,000 documents a day, so it is updated very rapidly.

No search engine can claim to contain every document available on the Web. To make it easier to use more than one search engine at once, some sites, such as SavvySearch, send your query to several search engines at once. Also note that many catalogs also contain search engines. For instance, Yahoo is good for either browsing by subject or searching directly by keyword.

It's easy and intuitive to use search engines and catalogs. If you're using Netscape, click the Net Search button to get a page full of links to search pages. Visit one of them and experiment to get a feel for how they work.

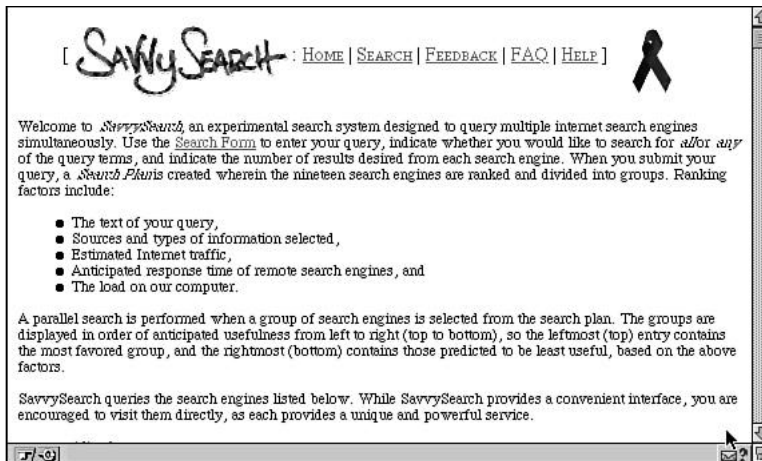

Figure 14.1

SavvySearch checks multiple search engines.

Non-Web Search Engines

Several useful search engines for conducting non-Web site searches are available, including *Archie* for FTP searches and *Veronica* and *Jughead* for Gopher searches. You can also search for someone's email address or a company's domain name, and more searches are becoming possible all the time.

Archie creates and searches its own huge database listing of the publicly known files available through FTP. As such, *Archie* proves to be a tremendous search tool in helping you locate specific software available on the Internet. *Archie* provides the file name only, not the contents of the file.

Some software, such as *Anarchie*, enables you to search *Archie* archives and download the files that look interesting. You can also access *Archie* in other ways: Send an email message to archie@archie.internic.net with

“help” in the body of the message, or Telnet to archie.sura.net (login as qarchie). It might be easiest to use Archie right from a Web page, such as Rutgers University’s Archie Request Form or CUI’s ArchiePlexForm.

Use the Veronica and Jughead tools, accessed from your Gopher client, to search Gopher databases. (Most Web browsers do double-duty as Gopher clients as well.) You’ll find a Veronica or Jughead menu on many Gopher sites. Veronica searches through all of “Gopher space,” often resulting in hundreds of search results. Jughead searches through a specific subset of Gopher and thus can be quicker and more accurate, though less comprehensive.

If you’re trying to find people or businesses on the Net, there are also ways to search for email addresses and domain names. Check out the helpful Email Address-Finding Tools Web page, which uses Web sites, Gopher sites, and Telnet sites to assist you. There is also a form on the Web to help you find domain names based on keyword searches.

Free Stuff for Creative Professionals

We’ve all spent countless hours tracking down the photos and clip art that we need for our work. Now all that time can be greatly reduced by using the Internet. The Net is a good resource to locate stock photos and clip art, acquire fonts, download software, and more.

You know how difficult it is to find just the right photo for a comp? Well, now you can do it the easy way: by connecting to the Web sites of any number of well-known stock houses (see “At a Glance”), such as Blackstar or Tony Stone Images.

Just visit the site and type in a few keywords for the image you’re looking for. When you find just the right image, most stock houses on the Internet will email a low-res version of the photo to you, or enable you to download it via an FTP site to paste it into your layout. After your client approves the photo, you can call or email to the stock house people and they’ll express the original or a high-res file to you.

Companies such as PhotoDisc offer the hybrid option of stock photos on CD-ROMs that are accessible via the Internet. You can download free samples to use and browse through entire collections of photos before submitting your order online.

In a few years, it’s likely that we’ll be able to download high-res photos directly. For the time being, however, downloading a 50MB high-res 8" × 10" color photo requires a significant amount of time—under ideal circumstances, more than five hours using a fast 28.8 Kbs modem. Even over a faster connection, transferring such a file over a busy network might take a few hours.

There’s a lot of high-quality clip art on the Net, too. Clip art Web sites are great places to visit when searching for just the right image. For more clip art than you’ve ever dreamed of, check out Sandra’s Clip Art Server (see “At a Glance”).

Check Out These Fonts

The Internet has lots of fonts available for you at font houses that you can visit (see “At a Glance”). But keep in mind that at the present time, major font suppliers haven’t yet made their valuable copyright-protected fonts available online. There are, however, plenty of freeware fonts available, though they may or may not meet your professional standards. Check out the Internet Font Archive. From there you can link to any number of sites, including the `mac.archive.umich.edu`.

The fontsOnline interface incorporates a process that enables the user to examine the fonts on a feedback page. You can choose to preview a font using any short phrase of your choosing, which is then rendered by the fontsOnline server and returned to the Web client as a downloadable graphic. If desired, the font can be ordered directly through the system, and is available for FTP downloading when the payment information has been authorized. The entire Alphabets, Inc. library is also shown in an exclusive Adobe Acrobat PDF (Portable Document Format) format catalog, designed to be viewed directly online using the Acrobat plug-in for Navigator, which extends the capabilities of Navigator to handle new content as it’s introduced. In addition, these Acrobat catalog pages can be downloaded and printed locally at high resolution to show the detail and characteristics of the fonts. You can also acquire A*I font animation by bYte a tree productions and other creative types.

In addition, there are any number of other font-related services available via the Internet that are also quite worthwhile. One such site is Graphion’s Online Type Museum, where you will find information about the history and practice of typesetting. Or you might want to visit the Internet Font Browser to search through hundreds of typefaces, or the Will-Harris House to view the *Typofile* Magazine. By the way, while you’re at the Will-Harris site, check out the Esperfonto hypertext system to find the most appropriate typeface for your next job.

NOTE

Paying for art, fonts, or software downloaded over the Internet is still a bit problematic, because it’s not necessarily safe to send your credit card number across the Internet. But things are changing. Netscape, for example, has server software that companies can use to ensure the security credit card transactions when you visit their Web site. Other companies are investing in “virtual banks” that enable you to buy things with your cash electronically. (Take a look at *Mastering Netscape 2.0 for Macintosh* for a detailed explanation of how you can protect your sensitive information on the Net.)

And There’s Software, Too?

Another amazing feature of the Net is that you can find a certain amount of free software from commercial developers’ Web sites—mostly things like viewers for files generated by Adobe Acrobat and Virtus VR. In addition, the Internet is a great place to find upgrades, patches, and fixes for your commercial software. At the manufacturer’s Web site, locate the upgrade, patch, or the fix you need and download it. Visit the Apple Support and Info Web site to download all kinds of upgrades and patches (see “At a

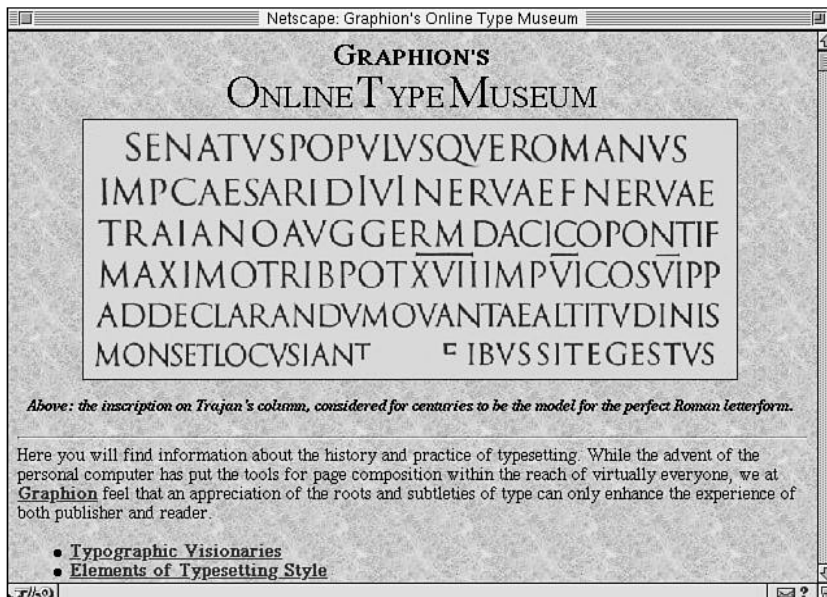

Figure 14.2
Check out *Online Type Museum* for the history and practice of typesetting.

Shareware is software distributed as a trial, giving you a chance to try it. Search for the item, download what you need, and send in the required payment for whatever you want to keep and use. Great freeware and shareware that is extremely useful is available for downloading from the Net. Getting it is as easy as visiting a few archive sites on the Web. The biggest, oldest, and most useful archives are maintained by universities, such as the Info-Mac archives at Stanford University and the University of Michigan Mac Archive.

Because access to these archive sites can be difficult due to their popularity, many mirrors—sites containing copies of the entire archive—have been set up. Usually, you'll be notified of available mirror sites you can try. Yahoo's shareware listings can also be helpful.

Professional Development

Another useful resource online is the plethora of creativity you can find on Web sites for your inspiration. Some good ones to visit include Clement Mok designs, the World Wide Web Virtual Library on Design, the Web Louvre, freeSpace, and A Global Canvas: The Museum Book of Digital Fine Art (see "At a Glance").

A wealth of information is available from different sources on the Web that you can use to help you solve your business-related problems, get advice, and get new and creative ideas. Frequently Asked Questions (FAQs) are good places to look for tips and techniques. Find particular FAQs by searching Yahoo, Lycos, or InfoSeek to search for "<the subject> FAQ" (see "At a Glance"). Also, Web pages such as the Usenet FAQs Web page will help you to locate new FAQs. It's a good idea to check out FAQs relating

to any hardware or software problems that you may be encountering. If a Usenet newsgroup has a FAQ, then you'll find it posted to the newsgroup at regular intervals—usually every three weeks. You might also check out the Usenet FAQ Archive, where every newsgroup FAQ is archived and updated whenever it changes.

Another way to get timely tips and advice is to visit major hardware and software sites on the Web, because they often cover techniques for specific subjects regarding their products.

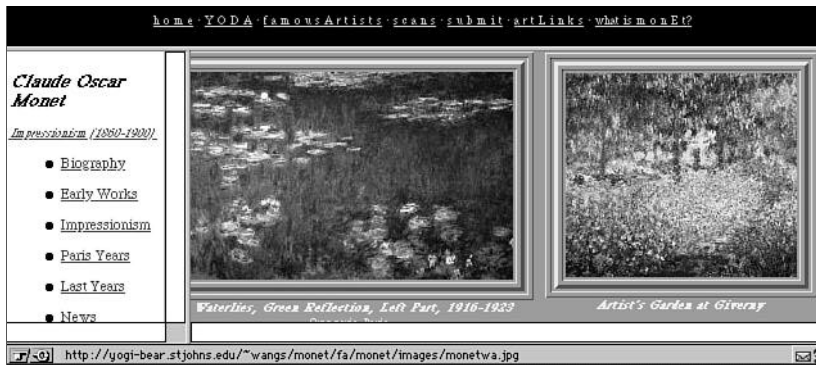

Figure 14.3

Take a refreshing break at the Web Louvre for inspiration!

Drumming up Business

Most of the information of this chapter has offered ways for you to build your business as a creative professional. All of this helps you when it comes to your clients, because your ultimate presentation skills on the Net become especially evident with them. The whole process from finding new clients to cultivating a solid working relationship with them can definitely be enhanced through the Net.

Find New Clients

What could be a more effective and dynamic way to cultivate new clients than to have them see great samples of your work on your Web page! The Internet can play a significant role in helping you find new clients and promote the services of your firm. Although many Internet services can be of help in doing so (for example, you can email prospective clients, maybe even sending them your portfolio in an electronic format), the Web is arguably the most important area for

My notion of truth: set limits, and choose a path. I cannot hope to know everything about everything. I've chosen to focus on imaging software (Photoshop, Illustrator, Live Picture), QuarkXPress, and the Mac OS. I'm fitting in HTML stuff out of necessity, but know that true WYSIWYG editors are on their way. I'm not too stressed about becoming a Web guru. I'll continue to concentrate on the idea, and let software and hardware take care of themselves.

Joe Shoemaker
On-Line Services
Creative Director
Indianapolis Newspapers,
Inc.

designers. Putting up your own Web page to advertise your services is easy and effective. You can effectively publicize your page by linking to and from other sites.

Research Clients

Now that you have new clients, you can turn to the Internet once again to do a quick search and take a look at their Web pages. You'd be surprised what an analytical review of a Web site can reveal about a company and its culture.

If your clients don't have a Web site, search for information related to the company using Lycos, InfoSeek, or another search engine (see "At a Glance"). You could try a WAIS search, but WAIS-indexed information is largely limited to academic and research organizations. WAIS is a good idea for companies to organize and distribute information, but it takes a lot of work to set up and to index, and it's largely limited to static files. Most companies would rather just set up a Web server to distribute information about their companies.

Doing Market Research

Perhaps the most productive research you can do on the Internet is not *on* your new clients but *for* them. As you can imagine by now, the Internet, with its megalibraries of information, is an ideal research assistant. It's interesting to note that many clients want excellent design executed in a beautiful manner, yet they have very little idea of what they want to communicate. So your work may include not only designing, but also analyzing and developing content. The Web provides the means to conduct research about your clients, their market and industry, as well as their competition.

To learn more about a certain market or industry, there are a lot of places you could go on the Web, because more companies and information sources are going online every day. First, try the same catalogs and search engines. You'll probably find all sorts of other companies immediately, and what better way to become familiar with a marketplace than to compare all the competitors?

There are also specific business directories on the Web, many devoted to particular industries (check out Yahoo Business & Economy section). And no doubt, in your searches you'll come across additional valuable Web, Gopher, and other sites that pertain to the specific market you're researching. The Net tends to reward this way—the more you look, the more you find.

How to Build a Web Page

HTML, or HyperText Markup Language, is a system for marking up text for Web pages. It's a little like spec'ing type in the pre-DTP days... basically, you add tags to sections of the document with instructions that mean things like "bold this phrase" or "insert a picture here." For example, the HTML

```
<center><b>BLOOM</b></center><br>
<i>(Halts erect stung by a spasm.)</i> Ow.
```

displays as:

BLOOM

(Halts erect stung by a spasm.) Ow.

The tags merely specify how the browser should display the text. (
 specs a line break, and <I></I> spec bold and italic, respectively.)

HTML also allows you to spec things like links to other documents and form components like buttons and check boxes. Although this may be new to you, it's certainly not difficult, and if you're interested, you can pick up HTML very quickly.

If you're a designer, you'll probably hate HTML—at least the current version, HTML 2.0, because it offers very little control over the way type is displayed. You *can't* spec the font, or the leading, or the tracking, and even your control of the type's size is relative to defaults set by the browser's user.

It's beyond the scope of this book to teach you HTML, and in any case, you don't need to know too much about HTML if you don't want to mess around with it. I suspect that you don't do much PostScript programming, but it's likely that you routinely produce PostScript code with Quark or PageMaker. Likewise, new tools like Adobe PageMill enable you to create HTML documents without writing HTML code line by line.

Very basic [PageMill]. Easy to learn, but you get frustrated with the limitations imposed. Went out and bought one of those "boat-anchor heavy" HTML books and filled in the gaps.

Stephen Holmes
Graphic Art Computer Lab
Swinburne University of
Technology

Ratings

PageMill	1	2	3	4	5
Ease of Use					
Great Features					
Coolness					
\$ Value					
Overall Rating					

If you *are* interested in HTML, you'll find that there are dozens and dozens of books and zillions of Web sites that cover the basics. May we recommend:

- World Wide Web Design Guide* (Hayden Books)
- Publishing on the Web* (Hayden Books)
- For a more advanced title for those already creating Web pages, try *Creating Killer Web Sites* (Hayden Books)
- Teach Yourself Web Publishing with HTML in a Week* (Sams Publishing)

You'll also discover that the entire Web is one giant swipe book. To learn new techniques for handling the special issues of Web page design, you just need to go to the Web pages that you really like. Because most Web browsers enable you to view a document in either its formatted form or as its HTML source code (from the Netscape Navigator menu, choose Document Source), it's easy to see the HTML tags. By reading the tags of a particularly successful document, you can teach yourself HTML very quickly.

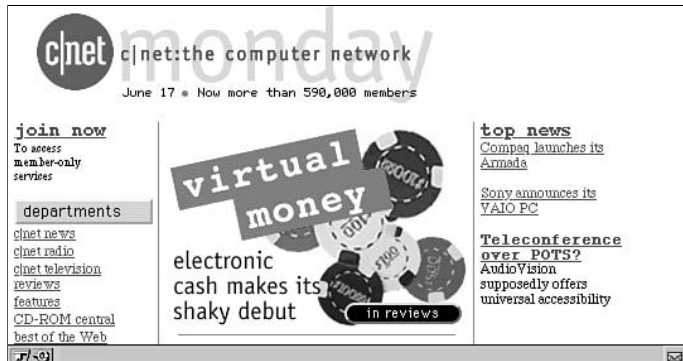

Figure 14.4a
Find a Web page you like...

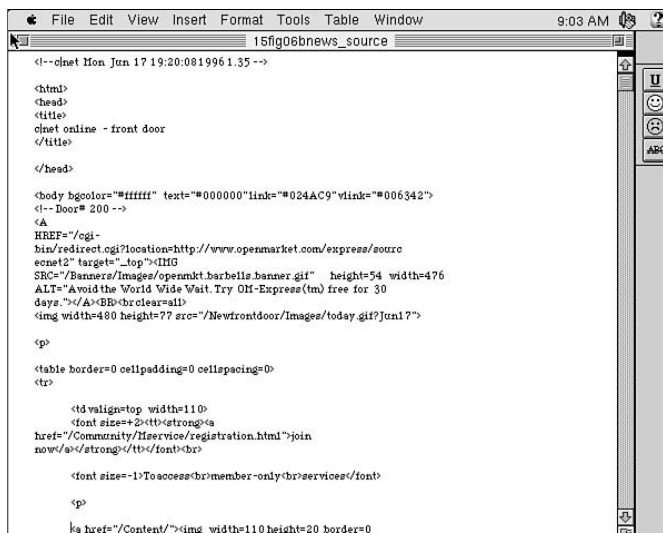

Figure 14.4b
...and view its source code to see the HTML tags.

Using PageMill

Adobe PageMill and its souped-up sibling, Adobe SiteMill, are among the first commercial WYSIWYG (What You See Is What You Get) HTML editors. If you're an experienced user of page-layout software, you'll find PageMill very familiar.

To use PageMill, you simply type or import text (via cut-and-paste, at least in version 1.0) and apply HTML tags using the Attributes Inspector—a cousin of PageMaker/Quark style palettes—or with familiar keyboard shortcuts. You can import pictures through the File menu, or by dragging the picture's icon into the PageMill window.

To link to another page, you simply drag that page's icon from the PageMill title bar into the page that will contain the link. PageMill automatically generates a hypertext link with the name of the linked page, and you can edit the link's text or location if you like.

If you've had experience with writing HTML the old-fashioned way (like we did in the primeval days of '94) you can edit your finished PageMill document with whatever text editor you like—Word, SimpleText, and BBEdit are popular choices.

PageMill is about as simple as Web page design can get. The forthcoming version of PageMill, due in the fall of 1996, will support more sophisticated text-importing and text handling, new tags, and the capability to edit a document's HTML directly if you're so inclined.

For more information on Adobe PageMill, consult the PageMill Handbook (Hayden Books).

NOTE

At the time of this writing, PageMill is still at version 1.1, although version 2.0 should be out a few months after this book is released. As with most 1.0 releases, PageMill has some flaws, and can sometimes crash. Given the high quality of Adobe's DTP products, it's likely that many of these bugs will be fixed in the 2.0 release.

Ratings

BBEdit	1	2	3	4	5
Ease of Use					
Great Features					
Coolness					
\$ Value					
Overall Rating					

Netscape Extensions

If you design Web pages, sooner or later you'll encounter the issue of Netscape extension. Netscape has created its own tags that are not part of the basic HTML language, and there are some Web browsers out there that don't know what to do with Netscape tags.

Some Web page designers think that Netscape tags are great—they allow effects that are pretty darn essential for good design (like using <TABLE> tags to create margins, for instance.) Some purists think that Netscape tags are exclusionary, and a Web page should look the same, no matter what browser is used to view it.

It's difficult to insist that Web pages be viewable on all browsers, particularly when Netscape Navigator and Microsoft Internet Explorer (which is completely Netscape-tag compatible) control more than 80 percent of the market, but we are honor-bound to remind you that your page may look different if someone's reading it with, say, the HotJava browser.

Ratings

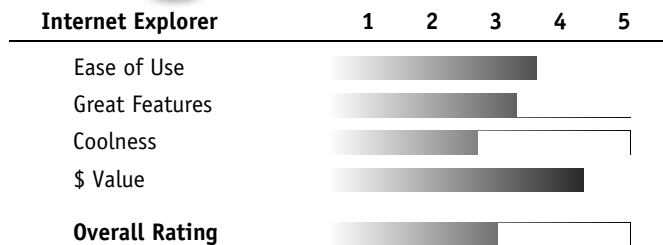

Marketing Your Pages

After you've created your nifty Web site, you're done, right? Wrong. There are millions of Web sites out there, so you'll want to have multiple ways to access your page. You accomplish this by providing good links to your site. Promote your Web page by putting links to it in places that your clients are likely to find. This should be your goal—new clients finding you. In fact, that's what promoting your services on the Internet is all about.

The first thing you want to do is register the URL for your home page with the most popular search engines (see "At a Glance"). All WWW search engines attempt to catalog as many documents from the Web as possible by loading and cataloging every document listed in a database of URLs. Every link on these documents is automatically explored by the search engine, and any new documents found are cataloged. Some search engines make it easy to let you add your own URL to its database of initial pages to search. This ensures that people will be able to find your page if they conduct a search using appropriate keywords.

Registering with Catalogs

Yahoo is probably the most popular subject-organized catalog (or directory) of the Web, but there are also other useful directories, such as GNN's Whole Internet Catalog, The WWW Virtual Library, and EINet Galaxy (see "At a Glance"). Each of these has a method for contributing new URLs. Your URL is not automatically added to these directories; instead, your URL will be added only if the people behind the directory explore it and find it to be appropriate for their catalog. But don't worry—if in fact you started a significant new Web page, you are likely to be included in at least some of these catalogs.

Registering with What's New Lists

If you want your home page to receive lots of exposure, you might also submit it to be potentially included in the Netscape Navigator and NCSA "What's New" lists. These Web pages are regularly updated lists of new sites on the Web, read by thousands every week. If your site is really interesting, it may also be included in a "What's Cool" list, such as Netscape Navigator's list, which is a sure way to gain a lot of *hits*.

Other Methods

Linking is where it's at in using your home page to advertise your services. It's the ultimate form of networking. Make it your goal to get as many contacts as you make on the Net to link to your site. It won't be long before lots of folks will be lining up to take a peek at your great work.

There are plenty of other methods you can pursue to promote your Web page. For instance, you could post a brief description and URL in appropriate Usenet newsgroups. Or, you could locate mailing lists covering topics related to your page and mail a description to them. It's also a good idea for you to include your URL in your email signature, put it on your letterhead and business card. But again, what's most important is to always ask the maintainers of other related pages to include a link to your page. If you do, though, don't forget to return the favor and include a link back to their page. Finally, be sure to include a link back to your page with every site you design for your clients. This is a great way for clients to sample your wares.

Converting Existing Documents to Web Format

What about your existing documents? You probably have a large portfolio of finished documents, and it seems like a waste of time to re-create each of them—if it's even possible—in HTML. Is there an easy way to reuse print-based layouts? In short, yes.

Adobe Acrobat

Adobe Acrobat is a whole family of products from our friends at Adobe. The various Acrobat applications work together as a system to create *Portable Document Format* (PDF) files. Portable Document files are small, platform-independent files that retain their layout, fonts, and so on when transferred to another machine—even if the machine doesn't have the document's fonts installed.

The Acrobat Reader, which enables users to view PDF files, is freely distributed by Adobe. Adobe has also developed a plug-in for Navigator that allows the browser to view files in its own window without launching Acrobat Reader. (This plug-in was still being beta-tested as of this writing; a release version should be out by the time you read this.)

Acrobat is based on PostScript, so it's very simple to use the commercial applications, Acrobat Distiller and Acrobat Exchange, to create PDF documents from existing PageMaker and Quark files. (In fact, you can export directly to Acrobat with the File menu's Export command in PageMaker 6.0.)

Conversion Utilities

In some situations, you may decide it's best to present documents as HTML rather than in Acrobat format. You can use utilities that convert existing files, such as Microsoft Word 6, Excel, Adobe PageMaker, and QuarkXPress documents into HTML format (see "At a Glance"). Some of these utilities offer more than others, so you may want to think about how complex your documents are before you attempt to use a particular utility.

With conversion utilities, you have tools to revise, edit, rearrange, and apply HTML tags to the document contents. Some of these utilities also have the important advantage of leaving the original document unchanged, while displaying the changes it made in the HTML document. Look for the features to be able to revise elements of the original document, such as stories, headlines, and pictures.

Certain conversion utilities create pointers to the text and image boxes of a document to which it applies style and linking tags. So when changes are made to the content of any box in the original document, these utilities will allow for the automatic updating of the HTML document as it is exported.

Note that some utilities require you to constantly switch back and forth between a Web browser and your document to view the results of your HTML formatting, because Web documents can't be viewed from within the program. Not all conversion utilities offer the same level of flexibility, so it's a good idea to keep in mind the different features you're going to need before you start using one.

Graphics File Format Issues

It's a pretty safe bet that most of the image files you've worked with in page layout programs have been in TIFF or EPS format. (OK, some of you high-end types may occasionally deal with Scitex files.) These formats are well-suited for print applications, but they're not commonly used in the design of Web pages.

Why? Basically, they're too big. Remember, when a user looks at your Web page, the user's browser must download every picture on the page over the Net. In order to speed up this process, and to ease network traffic, the more compact image file formats, such as GIF and JPEG, are used to make the file sizes smaller. In most cases, these files are substantially smaller than their TIFF and EPS counterparts, with comparable image quality.

Resolution

Before we talk about the particulars of GIFs and JPEGs, let's talk about resolution issues, which apply to both file formats.

Because a Web browser displays images on-screen, it only needs 72 DPI to display a good-looking picture. *In fact, anything over 72 DPI is wasted*—the browser won't display it on-screen, and it will take longer to load over the network. If you're scanning for the Web, scan at 72 DPI. If you're using existing scans, be sure to sample them down to 72 DPI with Photoshop's Size command on the Image menu.

GIF Files

GIF stands for *Graphics Interchange Format*, and the format was developed by the folks at CompuServe for the purpose of exchanging graphics files across platforms using modems. As a result, it's a perfect format for Web page images.

Ratings

CompuServe	1	2	3	4	5
Ease of Use	■				
Great Features	■				
Coolness	■				
\$ Value	■				
Overall Rating	■				

If you're an experienced Photoshop user, you're accustomed to thinking in channels—images are made up of separate layers that contain the image's RGB or CMYK components. (You can easily see these layers with Photoshop 3.0's Layers command, or by cycling through ⌘-0, ⌘-1, ⌘-2, ⌘-3, and (in CMYK mode) ⌘-4.)

GIF files are substantially different. Everything is in one channel, and the GIF assigns colors from a ready-made palette of no more than 256 colors. Each color in the palette is defined using the RGB model, but individual pixels don't have separate red, green, and blue components.

As a result, GIFs are about 3 times smaller than RGB files, and 4 times smaller than CMYK files. (They're not exactly 3 or 4 times smaller, because the GIF has to store the palette internally.) The price is a smaller gamut of colors. Different GIF-creating programs use different techniques for squeezing the RGB gamut into a GIF palette, and some GIF-savvy packages (such as Photoshop) enable you to choose among several options for creating a palette:

- Exact**—Uses the RGB colors from the RGB document to build the palette. If the image uses more than 256 colors, Photoshop punts, using patterns to simulate the unavailable colors.
- Adaptive**—Creates a set of colors that is optimized for the picture. Again, Photoshop will fake any colors that are not available.
- System**—Photoshop uses your Mac's system palette—i.e., the palette your monitor uses to create its display—to create the GIFs palette.

NOTE

Netscape uses only one palette to display all the GIFs on a page, so if you have several GIFs with radically different palettes, at least one of the GIFs is going to look funny to darned-funny. The usual solution to this problem is to stick all of your RGB images into one big Photoshop file, convert it to Indexed Color so that they all have the same palette, and cut-and-paste each image to its own file. It's tedious, but it yields the best results.

Special Flavors of GIF

You'll see a lot of GIFs on the Web that seem to appear blurry when they first load, and gradually come into focus. These are *Interlaced GIFs*. The bytes in the file have been reordered so that viewers can see the big picture first, and the details later. Although the complete interlaced GIF loads in exactly the same amount of time as a regular GIF, interlaced GIFs *seem* to load more quickly.

Although a standard installation of Photoshop can handle basic GIFs, it's not set up to deal with Interlaced GIFs. You need to use a conversion utility like GIFConverter, or Adobe PageMill to create Interlaced GIFs. It's likely that a future version of Photoshop will handle all the "new" GIF formats (even though some have been around for a few years).

You've probably seen transparent GIFs too. These GIFs, called GIF89s, allow the background of the Web page to show through a color that has been designated transparent in the GIF file. The result is very much like placing an EPS file that contains a clipping path in a page layout program.

JPEG Files

JPEG stands for *Joint Photographic Experts Group*, the organization that created the JPEG file format. Unlike GIFs, JPEGs use a full RGB or CMYK color space, *and* they're comparable in size (or even smaller) than GIF files. They achieve this compromise through a special form of compression.

Ordinary compression—as used in utilities, such as StuffIt and Compact Pro, “abbreviates” the information in a file. All of the file's original information can be reconstructed from such an archive, and the decompressed file is exactly like the original. Because this kind of compression isn't tied to any particular file format, or even data type, you can use ordinary compression to stuff applications, pictures, text files—anything—reducing the size substantially.

JPEG, which is designed for photographs, goes a step further. JPEG throws away information that it reckons you probably can't see anyway, and compresses what's left. Although the reconstructed file is not quite the same as the original, the results are usually quite good, and files compressed with JPEG are dramatically smaller than those compressed with ordinary compression.

When you save a file in JPEG format, the JPEG-creating application usually gives you a range of compression-quality options. As you'd suspect, the smaller you compact a file, the more you can see the side-effects of compression. You'll have to experiment with individual images to see how they are affected by JPEG, but in general, you are most likely to see the artifacts of compression—blurriness, distortion, and weird dark shadows—in images that contain line art or type, especially small type.

Transferring Files via Email and FTP

The prospect of sending files to service bureaus and printers via the Internet is very exciting to many Mac professionals. File transfers can take place very quickly, and there are no messenger or Fedex charges.

Is the technology in place? That all depends on what you'd like to do. It's certainly possible to use email to buzz text files around. This writer has a Chicagoan's natural distrust of Indiana, and has never set foot in Indianapolis, home of Hayden books—every transaction with my publisher is via email.

Ratings

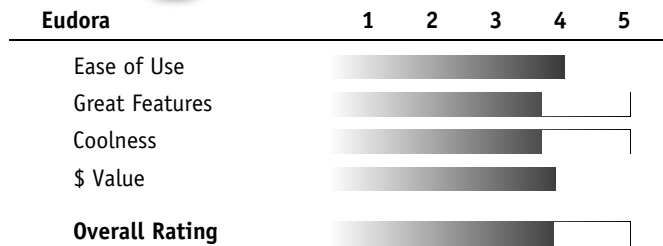

Ratings

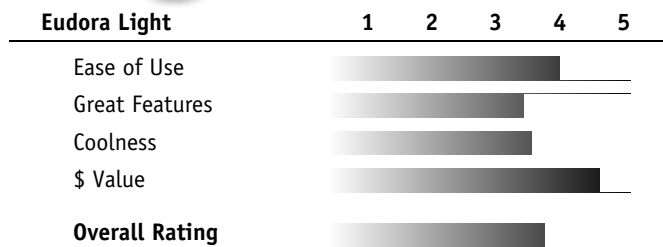

Ratings

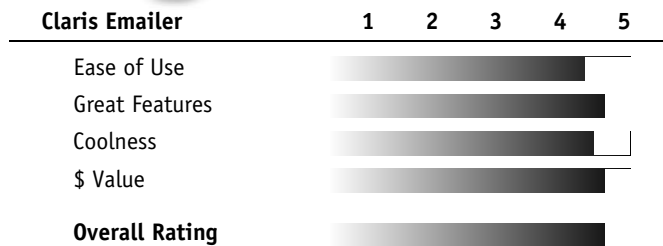

If you're thinking about transferring files to printers and service bureaus via the Net, you may need to wait a few years. Depending on the speed of your connection to the Net, and the speed of the recipient's connection, it may be practical to transfer files of up to say, 5 to 10 megabytes via the Internet, but network traffic may slow your transfer to an unacceptable speed.

Also, you need to decide how you'll handle proofing. The need for physical proofs limits the geographical freedom that the possibility of sending files over the Net offers. The particular issues you face depend on your workflow, your quality standards, and your relationship with your printer. It's unlikely, however, that you are prepared to send your files and hope for the best.

Transferring Files

When you do decide it's appropriate to send large files using the Net, you should almost always use FTP, or file transfer protocol, rather than email to send your files. FTP is better suited for transferring large files than email, and cross-platform file transfers work much more smoothly, as FTP clients behave much more consistently than email packages.

FTP uses the client-server paradigm. One machine runs FTP server software, and allows logins and transfers by machines running FTP client software. Both FTP server and client packages are available on the Mac.

NetPresentz is a widely used shareware FTP server program for the Mac. You can configure NetPresentz to allow users to log in based on your AppleTalk file sharing preferences. (NetPresentz also functions as a basic Web and Gopher server.) Anarchie is available on many online services and Internet sites. *Be sure to read the documentation closely, to make sure that your file sharing is set up correctly.* Allowing others free access to read and write to your hard disk is dangerous. (The risk is probably not *too* great if you don't advertise the fact that your hard drive is open to all comers.)

Ratings



Ratings

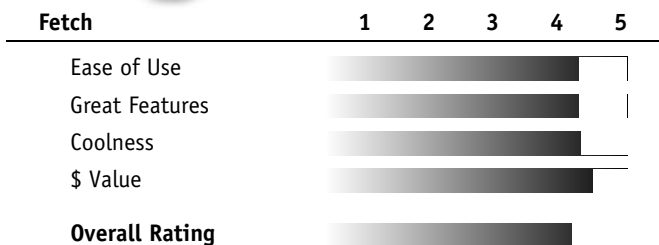

A popular shareware FTP client is Anarchie. Uploading and downloading files is a double-click away. The interface is intuitive enough that you won't even have to read the accompanying online manual that comes with it. Anarchie is available on many online services and Internet sites.

Another popular FTP client is Fetch. Although less intuitive than Anarchie, Fetch has many built-in file management capabilities that make it worthwhile. Fetch is available for download on many Internet sites and

At a Glance: Check Out These Sites!

Use this handy URL reference to locate sites listed in this chapter and other interesting pages.

AOL: America Online, <http://www.aol.com>

Audio: Perspective, <http://jcomm.uoregon.edu/~perspect>
 SoundMachine, <ftp://ftp.ncsa.uiuc.edu/Mosaic/Mac/Helpers>
 SoundApp, <ftp://sunsite.unc.edu/pub/multimedia/utilities/mac/audio>
 RealAudio, <http://www.realaudio.com>

Audio Editors: SoundHack, <http://hyperarchive.lcs.mit.edu/cgi-bin/NewSearch?key=SoundHack>
 ↳ [bin/NewSearch?key=SoundHack](http://hyperarchive.lcs.mit.edu/cgi-bin/NewSearch?key=SoundHack)
 SoundExtractor, <http://hyperarchive.lcs.mit.edu/cgi-bin/NewSearch?key=SoundExtractor>
 ↳ [cgibin/NewSearch?key=SoundExtractor](http://hyperarchive.lcs.mit.edu/cgi-bin/NewSearch?key=SoundExtractor)

Book Lists: Graphics Design Books Information,
http://www.uta.fi/~samu/graphic_design_books.html

Catalog Registration (To add your URL):

Yahoo, <http://www.yahoo.com/bin/add>
 GNN's Whole Internet Catalog, gnnews@ora.com
 The WWW Virtual Library, <http://www.w3.org/hypertext/DataSources/bySubject/Maintainers.html>
 ↳ [Maintainers.html](http://www.w3.org/hypertext/DataSources/bySubject/Maintainers.html)
 EInet Galaxy, <http://www.einet.net/cgi-bin/annotate?Other>

Client Pull, Server Push: Netscape's Dynamic Document Features,
http://home.netscape.com/assist/net_sites/dynamic_docs.html

CompuServe: <http://www.compuserve.com>

Conferences: American Institute of Graphic Arts, <http://www.do1.com/AIGA>

Design Info: DTP Internet Jumplist, <http://www.teleport.com/~eidos/dptij/dtpij.html>
 UNB Graphic Services, http://degaulle.hil.unb.ca/UNB_G_Services/GSHomePage.html

Dynamic Documents: Netscape's Dynamic Document Features,
http://home.netscape.com/assist/net_sites/dynamic_docs.html

Email: http://ibc.wustl.edu/domain_form.html

Events: DCI home page, <http://www.DCIexpo.com>

FAQs (frequently asked questions): Usenet FAQs, <http://www.cis.ohio-state.edu/hypertext/faq/usenet>
 ↳ [hypertext/faq/usenet](http://www.cis.ohio-state.edu/hypertext/faq/usenet)
 Usenet FAQ Archive, <ftp://rtfm.mit.edu/pub/usenet>
 Photoshop mailing list, <ftp://ftp.asi.com/pub/photoshop>

Fonts: Internet Font Archives, <http://jasper.ora.com/comp.fonts/Internet-Font-Archive>
mac.archive.umich.edu, <http://mac.archive.umich.edu/index.html>
 fontsOnline, <http://www.do1.com/fontsOnline>
 Graphion's Online Type Museum, <http://www.slip.net/~graphion/museum.html>
 Internet Font Browser, <http://cuiwww.unige.ch/InternetFontBrowser.html>
 Will-Harris House, <http://www.will-harris.com>
 Letraset, <http://www.lettraset.com/lettraset>

continues

continued

HTML Conversion Utilities: MS Word 6 (Group Cortex), <http://www.netweb.com/cortex/content/software>

Excel, <http://www.rhodes.edu/software/readme.html>

Adobe PageMaker, <http://www.bucknell.edu/bucknellian/dave>

QuarkXPress (BeyondPress), <http://www.astrobyte.com>

HTML document layout software: Arachnid, <ftp://newton.uiowa.edu/pub/arachnid>

NaviPress, <http://www.navisoft.com/homedoc/press/press.htm>

HTML Info: <http://www.w3.org/hypertext/WWW/MarkUp/MarkUp.html>

A Beginner's Guide to HTML, <http://www.boutell.com/faq/#authoring>

National Center for Supercomputing Applications, A Beginners Guide to HTML,

<http://www.ncsa.uiuc.edu/General/Internet/WWW/HTMLPrimer.html>

Netscape's Creating Net Sites, <http://home.netscape.com/home/how-to-create-Web-services.html>

The Yale C/AIM WWW Style Manual, http://info.med.yale.edu/caim/StyleManual_Top.HTML

HTML text editors: http://www.yahoo.com/Computers/World_Wide_Web/HTML_Editors

Inspirational: Clement Mok, <http://www.cmdesigns.com/cmd.htm>

World Wide Web Virtual Library on Design, <http://www.dh.umu.se/vlib.html>

Web Louvre, <http://mistral.enst.fr/louvre>

Keyword Search: http://ibc.wustl.edu/domain_form.html

Major Manufacturers (Also, look inside product manuals for URLs):

Adobe: <http://www.adobe.com>

Canon: <http://www.canon.com>

Hewlett Packard: <http://www.hp.com>

IBM: <http://www.ibm.com>

Macromedia: <http://www.macromedia.com>

NEC: <http://www.nec.com>

Mailing Lists: listserv@ricevm1.rice.edu

Inter-Links' site, <http://www.nova.edu/Inter-Links/cgi-bin/news-lists.pl>

Markup Language Information: Guidelines for Electronic Text Encoding and Interchange, <http://etext.virginia.edu/bin/tei-tocs?div=DIV1&id=SG>

Microsoft Network: <http://www.msn.com>

NCSA Mosaic: <http://www.ncsa.uiuc.edu/SDG/Software/MacMosaic>

Netscape Navigator: <http://home.netscape.com>

Netphone: Electric Magic's NetPhone, <http://www.emagic.com>

Netscape Extensions: http://home.netscape.com/assist/net_sites/html_extensions.html

Networking: Designlink, <http://www.designlink.com>

Newsreaders: <http://wwwhost.ots.utexas.edu/mac/main.html>

On-Demand Printers: DocuNet Digital Document Services, <http://www.netudoc.com>

Prepress: Online Prepress Service, <http://www.wco.com/~billn>

PrePRESS Main Street, <http://www2.prepress.pps.com>

Global Prepress Center, <http://www.ledet.com/prepress/>

PrePress Online, <http://www.mindspring.com/~sledet/po>

Search Engines (To add your URL): WebCrawler,

<http://webcrawler.com/WebCrawler/SubmitURLS.html>

InfoSeek, <http://www.infoseek.com>

SavvySearch, <http://rampal.cs.colostate.edu:2000/>

Submit It!, <http://www.submit-it.com>

Service, Support, and Training: <http://www.adobe.com/Support/Service.html>

Software: Apple Support and Info Web, <http://www.info.apple.com>

Photoshop mailing list, <ftp://export.acs.cmu.edu/pub/PSarch>

StuffIt Lite, <ftp://ftp.utexas.edu/pub/mac/compression>

Father of Shareware, <http://www.halcyon.com/knopf/jim>

Shareware Central, <http://www.intac.com/~dversch/swc.html>

Qualcomm (Eudora), <http://www.qualcomm.com>

Stanford University, <ftp://sumex-aim.stanford.edu/info-mac>

University of Michigan Mac Archive, <ftp://mac.archive.umich.edu>

Yahoo, <http://www.yahoo.com/Computers/Software/Shareware>

Stock Houses/Clip Art: Blackstar, <http://www.blackstar.com>

Tony Stone Images, <http://www.tonystone.com>

Graphics on Call, <http://www.pacific-coast.com/GOCDemo.html>

The Stock Solution, <http://www.xmission.com/~tssphoto/tssphoto.html>

PhotoDisc, <http://www.photodisc.com>

Sandra's Clip Art Server, <http://www.cs.yale.edu/homes/sjl/clipart.html>

Video: Sparkle, <ftp://ftp.ncsa.uiuc.edu/Mosaic/Mac/Helpers>

VRML: <http://vrm1.wired.com>

Internet clients, <http://www.sgi.com/Products/WebFORCE/WebSpace>

What's New Lists (to add your URL): NCSA,

<http://www.ncsa.uiuc.edu/SDG/Software/Mosaic/Docs/Docs/whats-new-form.html>

15

Image Processing

The phrase image processing seems like a global term, under which could fall a wide variety of tips and teaching. After all, anything on a computer screen that isn't text is an image, and the very nature of being digital implies processing (without a processor, you have no computer). Before the typographers out there start screaming, I will concur that type is also a kind of image, and that it's an integral design element. This means that everything you see on your computer screen is an image, and the fact that it is on your screen in the first place indicates that it has been processed. Therefore, an inquiring (and perhaps too literal), reader could expect that this chapter is about all computing, in all its various forms.

Now that I've clearly made my point that the phrase "image processing" is less than descriptive, let me explain how I will use the term for the duration of this chapter. The *image* refers to a bitmap image, such as you would use in Adobe Photoshop. As you will see, this sort of image is very different from an Illustrator file or a DXF file used in 3D programs. Bitmapped files are images that may have been scanned, acquired from a stock photo house, or created within the application itself. The key to defining an image according to this chapter is the existence of pixels. If it has a pixel, it's an image, if it doesn't, it's a wireframe model, a vector image, or something else.

If you want to know... Go to...

What are the definitions of all the file formats?	298
What are color models?	297
How do I calibrate the color in Photoshop?	319
How can I speed up Photoshop?	308
Are there hardware settings that I can adjust to optimize Photoshop?	308
What are Kai's Power Tools?	311
What are the best plug-ins?	315
Are there any inexpensive image processing programs?	301
How do DPI, LPI, and PPI relate to each other?	295

Processing takes on a number of forms as well. It can be creative, design-oriented processing, or it can be as utilitarian as rotating or cropping an image. I think of processing as simply gaining control of the pixels within an image, both individually and globally.

Bitmap Basics

I said earlier that a bitmap image is defined by the existence of pixels. This can be a little confusing at face value, given that if it's on your screen, it's drawn with pixels. What I'm referring to here though, is the file's structure, rather than how the monitor interprets the file. A bitmapped image is made up of a grid of tiny squares that act as building blocks in defining the image (see Figure 15.1). The image detail and quality is determined by how many different colors can be represented by a pixel, as well as how many individual pixels are squeezed into the space. Almost all digital images from photographs are based on the bitmap structure (Why do you think they call it Photoshop?).

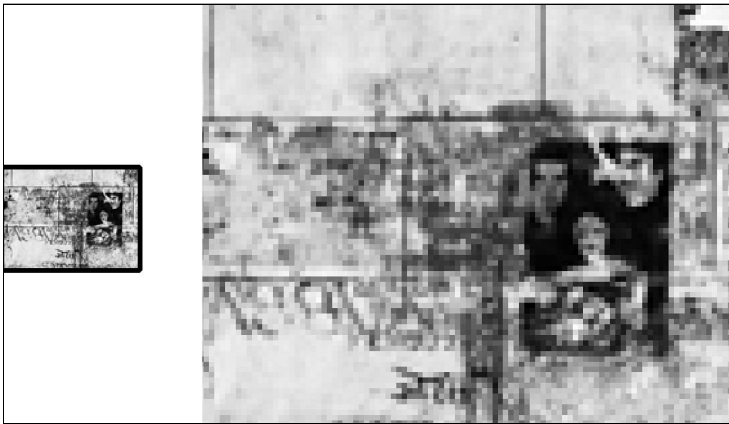

Figure 15.1

Bitmapped images are composed of a grid of picture elements.

Resolution and File Size

The resolution of an image is determined by the complexity of its pixel grid. In other words, how many pixels can be displayed in an inch. The more pixels in an inch, the higher the resolution.

As an image goes from scan, to screen, to print, the data elements we've been calling pixels sometimes take on different names. When an

What is Bitmap, Vector and 3D

One way to look at file formats is the method they use to map the image space. Bitmap applications create a grid that is filled with colored picture elements. These elements blend together to create the illusion of continuous tone. Bitmap images are able to create the most naturalistic images, although they are also the largest images.

image is scanned, for example, it is transformed from a continuous tone image into a series of pixels. Therefore, the term PPI is often used in this stage. Another common reference is dots per inch, or DPI. When an image is printed, it is usually rendered with dots on a desktop printer. Therefore, a printer's resolution is often referenced in dots per inch. PPI and DPI both measure per square inch, which means that 300 DPI and 300 PPI both refer to the same degree of resolution.

On the other hand, when commercial printers shoot film for reproduction, the film resolution is measured in lines per inch. This is an instance where the digital revolution has not been able to overthrow the tradition of the printing world. Lines per inch simply measures the number of elements in a linear way, instead of PPIs and DPIs methods of measuring per square inch. Therefore, you should cut the PPI and DPI readings in half to arrive at their LPI equivalent. For the sake of clarity and consistency I am going to continue using the term pixel throughout the rest of this chapter. Just be aware that other terms for resolution do exist.

The Impact of Resolution on File Size

Higher resolution delivers more detail in the image. The more variation you can get into a defined space, the more an object or a space can be articulated. The key to effective imaging is to use the right amount of detail for the task at hand. The same image should be depicted at various resolutions depending on where it's used. Using too low a resolution results in an image becoming pixelated, where the individual building blocks become visible, destroying the illusion of the image. Too much resolution results in a file that is unnecessarily large, which means longer processing times. In addition, an image can become muddy when its resolution is scaled down by the application.

High quality print jobs usually print at 200 LPI, (400 DPI/PPI). This delivers a smooth detailed result that responds well to the higher quality images and paper used by art and coffee table type books. Most magazines and standard books print at 150 LPI, (300 DPI/PPI), which works well for

Another file type is a vector-based image, found typically in drawing programs, such as Adobe Illustrator and Macromedia FreeHand. Vector files describe space mathematically, creating an outline with points and Bézier curves, and then filling it with a prescribed color or pattern. Vector images take up much less space, because they are more formula driven. They also are fully scaleable, without the size problems associated with bitmap files.

DXF Files are used in 3D modeling programs, and also are referred to as wireframe files. Like vector files, DXF files are also object based, only they describe dimensions on three axes instead of two. A cube rendered in Illustrator might consist of the two sides facing the viewer, while the same cube in a DXF file would probably describe all four sides. DXF files are created as a wire mesh that have properties assigned to them, describing the surface properties such as reflectivity and texture. DXF files are rendered with a process called Ray Tracing, which traces pixel values from the viewer's eye, back to each pixel. This renders a tremendous amount of detail. It accounts for light and shadow variation as it interacts with the object's surface properties.

the thinner paper stocks. Newspapers have the lowest resolutions of any print endeavor, due to their coarse newsprint stock, which delivers a poor tonal range and absorbs ink like a sponge. Newspapers usually go to press anywhere from 70-85 LPI (150-170 DPI/PPI). The translations from LPI to the DPI/PPI counterpart are approximations. The general rule of thumb is to multiply LPI by 1.5 to 2 to arrive at optimum resolution. This means that you could get very acceptable results at 150 LPI by using a 225 DPI image. It often depends on the paper, as well as the skill of your printer. Since these are variables, I have listed the higher value in going between LPI and DPI/PPI.

Monitors and Resolution

Open a 300 DPI image in Photoshop, and view it next to a 100 DPI version of the same image. Unless you zoom in for pixel detail, the two images look exactly the same on-screen. This is because monitors use a low resolution of 72 DPI to display their information. This low monitor resolution acts to homogenize images of higher and lower detail, reducing them to the lowest common denominator of 72 PPI. If you put a 50 DPI image next to its 72 DPI counterpart, you will see the image begin to break up, because the image has fallen below the 72 DPI resolution of the monitor (see Figure 15.2).



Figure 15.2

The left image is at 72 DPI, while the right image is at 50 DPI. Notice how the 50 DPI image begins to break up.

To see the other end of the extreme, print the 50, 100, and 300 DPI versions of the image to a high resolution printer, and you will quickly see the differences between them. A key point to notice, however, is that if you never print the image, the 100 and the 300 DPI images look exactly the same when viewed as a complete image. This is why Web and presentation designers are able to get away with designing at the low resolution of 72 PPI.

Color Models Used in the Imaging Process

There is a vast array of color models that can be used in imaging. There is RGB, HSV, CMYK, Indexed Color, LAB color, and many others. All of these color models refer to the way that color is mixed within your image. The two most common are RGB and CMYK, although we are seeing Indexed color becoming more common as Web design gains popularity. RGB is the native color model of your monitor, and CMYK is the native color model of offset printing.

RGB uses three main colors: red, green, and blue. It assigns 256 different degrees of variation to each of these colors. 256 levels are arrived at by multiplying pixel variables (called bits) eight times, hence the term 8-bit color. When the 8 bits of information is applied across the three red, green, and blue color channels, it is said to be 24-bit color.

CMYK uses the colors cyan, magenta, yellow, and black, applying 256 degrees of variation to each of these. It can be challenging to view CMYK images accurately on a monitor, given that it is using the RGB process to render images on the screen. The system has to depict the values in the CMYK model as best as it can. I will address methods of dealing with this later in the chapter.

Indexed color is used for Web design because it reduces the range of color possibilities down to a palette of 256 choices. In doing this, the size of the file is dramatically reduced, which makes it more conducive to posting on the Web. You usually design in an RGB mode, and convert to Indexed after the image is completed.

Other Color Models

The other color models, such as LAB color, and HSL are put to use for specific purposes. LAB color is a color space developed by the Commission International de Eclairage and is Photoshop's native color space. It is generally counterintuitive and difficult to use, as evidenced by its non-acronym description, where L=lightness, A=the polar differences between red and green, and B=the polar differences between yellow and blue (yikes!).

HSL stands for hue, saturation, and lightness. It is how the Macintosh Color Picker depicts color, with hues arranged around the edge of a circle, desaturating into gray as they converge in the center. Value adds black or white to the colors in the circle, changing the tonality (see Figure 15.3).

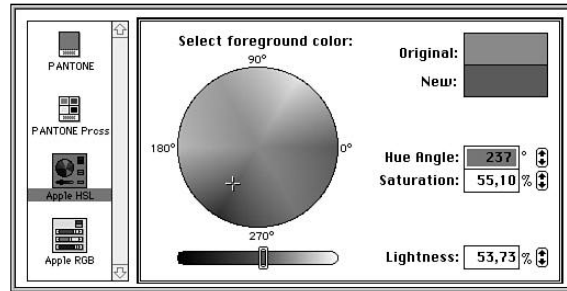

Figure 15.3
The HSL color model, as shown
by Apple's Color Picker.

What are the File Formats Used?

There are so many different formats for graphic files that it can be difficult keeping them straight. While there is a lot to choose from, most designers only use a few formats, based on what they are designing for. The following list should help you keep things straight, and tell you when to use what.

Amiga IFF—IFF stands for Interchange File Format. This allows files to be shared with the Amiga platform, usually for use with NewTek's Video Toaster. This is a cross-platform format.

Amiga HAM—HAM stands for Hold and Modify. This is an older Amiga format used with Photoshop 2.0. It allows a compressed version of an Amiga IFF file to be created. This is a cross-platform format.

BMP—BMP is short for Bitmap. It is the standard format for Windows and OS/2 files, and is the native format for Microsoft Paint. This is a cross-platform format.

CompuServe GIF—GIF stands for Graphics Interchange Format, and is a standard format for Web design purposes (along with JPEG). GIF formats use LZW compression and limit the file to 256 colors. This is a cross-platform format.

DCS—DCS stands for Desktop Color Separation. It's a QuarkXPress version of an EPS file, applicable only to CMYK images. This format saves the four plates as separate images, along with a composite review image. This is a Mac-specific format.

EPS—EPS stands for Encapsulated Postscript. This format is used when images are to be sent to a PostScript output device. It includes the actual file data, as well as a separate preview file to see the image on-screen. Most graphics applications work with EPS. Please note that Photoshop only recognizes a special form of EPS specific to Adobe Illustrator. This means that EPS files from other applications, such as Macromedia FreeHand, will not open in Photoshop. EPS is a cross-platform format, except for the Photoshop version of EPS.

Filmstrip—An export format used by Adobe Premiere, which depicts a video as a strip of sequential images. This format can be opened in Photoshop for editing, and then exported back to Premiere. This format is specific to Premiere and Photoshop.

IVUE—IVUE stands for Image View. Primarily used with Live Picture, the IVUE graphics format is optimized for FITS technology, although it may be used within Photoshop as well. This is specific to Live Picture and Photoshop.

JPEG—a compression format developed by the Joint Photographic Experts Group. Is a lossy compression scheme, meaning that it does sacrifice some image quality as it reduces the file size. JPEG is a universal file format.

LRG—a format developed by Fauve software, now used by Macromedia's xRES. Saves large files as a series of tiles with up to 32 channels. Not supported by other graphics applications. This format is exclusive to xRES.

MacPaint—MacPaint was the first paint program on the Mac. This format, still available in Photoshop, saves files in MacPaint's native format. This format is specific to MacPaint and Photoshop.

PCX—PCX is the suffix that PC Paintbrush assigns to all of its files. This format enables files to be shared with this application. This is a cross-platform format.

Photoshop 3.0—This is Photoshop's current native format, designed to retain information such as channel information and paths, which could be stripped away when a file is converted to another format. This is a native Photoshop format.

Photoshop 2.0—This is the native Photoshop format for its version 2.0. It is designed to retain information such as channel information and paths, which could be stripped away when a file is converted to another format. Files saved as Photoshop 2.0 files are usually larger than if they were saved in 3.0, due to compression algorithms built into the newer version. This is a native Photoshop formation.

Photo CD—The native format of Photo CD images based on the YCC color space. This space is translated into RGB when a file is opened. This is a cross-platform file format.

PICT File—PICT stands for Macintosh Picture, and is the native graphics format of the Mac OS, and its QuickDraw display language. It handles bitmap and vector images well, and delivers 32-bit support, which accommodates a fourth image channel if necessary. PICT is a universal file format.

PICT Resource—This format is specific to creating start-up screens on the Macintosh. Files with this format may be loaded into the System Folder and used as a start-up screen for your computer. (Name your file "startupscreen"). PICT resource is a universal format.

Pixar—Allows still images to be exchanged between Pixar workstations and Macs running Photoshop. This is a cross-platform format.

PixelPaint—PixelPaint was once a leading image editing application from Pixel Resources. This format, still available in Photoshop, saves files in PixelPaint's native format. This format is specific to PixelPaint and Photoshop.

PNG—Stands for Portable Network Graphics (pronounced "Ping") A recent format creation that seeks to challenge the GIF format as the Web's standard graphics format. This is a cross-platform format.

RAW—The RAW file format is stripped of all formatting information, such as bit depth, and color model. It is primarily for image files created with unknown or proprietary formats, especially in the mainframe arena. You can only open a RAW file if you know something about how it was created, such as the dimensions in pixels, the number of channels, and any header information. Without this information, using this format can be very difficult. The RAW format is a cross-platform file format.

Scitex CT—CT stands for continuous tone. Allows continuous tone grayscale and CMYK images to be exchanged between Scitex workstations and most image editing applications on the Mac. This is a cross-platform format.

Targa (also called TGA)—Enables images to be used with the TrueVision Targa video editing boards. This is especially valuable for graphics overlays and chroma keys. This is a cross-platform format.

TIFF—Stands for Tagged Image File Format. Developed by Aldus in the mid-eighties, TIFF delivers certain advantages for bitmapped images, although it does not support vector images. It saves multiple channels very well, and offers LZW lossless compression, which reduces the file size without sacrificing any image data. TIFF is a universal file format.

I get really tired of people who waste time with the PC/Mac or PageMaker/Quark debates. It doesn't matter, because every designer is different. You're going to be comfortable with whatever you're comfortable with; and it has no affect on what I'll use. If you learned commercial design first, you're more likely to be a PageMaker fan, because it's more like working with a pasteboard. If you learned design directly on the computer, you're at the mercy of your teacher's preferences.

Beth Rose
Lesman Instrument Company
Elmhurst, IL
Marketing Print and
Interactive Design

What Imaging Programs are Available?

The Macintosh supports a wide array of image processing programs, each sporting its own list of features and benefits. The most popular is Adobe Photoshop, given the fact it is one of the oldest, and that the Adobe OEM marketing people have bundled it with everything from scanners to small kitchen appliances. Everyone owns Photoshop, which makes it hard for

the competition to offer a comparable product at a similar price. They need to present new approaches to imaging, or they must compete on price. An important point to understand is that each program should be evaluated on its own merits. Each has its own strengths and weaknesses, and should not be held up against another. Although space prohibits listing every image editing application there is, some of the most significant offerings follow.

Color-It!: The Low Cost Leader

Image editing applications are powerful and complex programs, which can be attested to by their high price tags. Adobe Photoshop and Live Picture each list for \$999, and sell through discount catalogs for around \$650. If you're a student, or are on a budget, a full-featured image editing application that lists for \$149 would probably get your attention. That's what the people at MicroFrontier, makers of Color It! software are banking on.

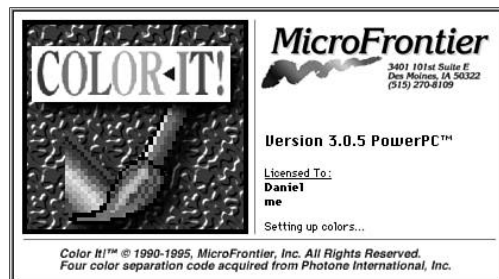

Figure 15.4
Color It! From MicroFrontier.

The first time I tried Color It!, I was lulled by its price tag into not expecting much. By the time I finished my first session, I was impressed by all that my \$149 could buy. There's no doubt about it, for the budget minded, Color It! is a real bargain. It sports a full set of tools and features, emulating the more expensive programs very well. It has the paint and smudge tools, foreground and background color swatches, filter support, and a full suite of selection tools. It was clearly based on the Photoshop model, and it does a great job of matching all of the basic Photoshop features, tool for tool. For general day-to-day requirements, Color It! will produce results similar to Photoshop, at a bargain price. In the hands of a skilled operator, Color It! can probably even deliver on some of the high-end features of Adobe's flagship product.

Although Color It! might take you to some of the same places as Photoshop, be prepared for a slightly bumpier ride. Much of Photoshop's intuitive feel, which has been cultivated over almost ten years of upgrades, is sorely missing in Color It!. It shows up in subtle ways, like a filter's preview mode that darkens the whole screen rather than just the image (just

like PS used to do in its 2.0 days). There's no layer or alpha channel support, and the program is more menu driven than Photoshop's floating palette approach. The result is a less intuitive experience, where it takes just a bit more thought or effort to get things done.

Painter: Textures and Brush Strokes

Painter, from Fractal Design, is unique among all bitmap applications. It focuses on reproducing the feel and texture of a wide range of artistic media. Want to make marks that look like oil pastels? Painter does it. Looking for watercolor effects? Painter gives you dozens of different options. It packs in a wide range of brush sizes and paint flows, while being able to re-create the look of virtually any artistic tool you can think of.

Ratings

Fractal Design Painter	1	2	3	4	5
Ease of Use	████████████████████				
Great Features	████████████████████				
Coolness	████████████████████				
\$ Value	████████████████████				
Overall Rating	████████████████████				

Adding to the tool selection is the texture selection. In the atom-based world, the mark left by a tool is influenced to a great degree by the surface being marked. Work with chalk on watercolor paper, and you get a very different result than when you use it on an unprimed canvas. Painter enables you to select your paper textures, and forces the media to behave accordingly. This is Painter's strength.

Painter does enable you to place images, and it lets you manipulate them with its various tools, but it does this almost grudgingly. Painter isn't known for its image control capabilities or for its advanced selection tools. It leaves these things to the other guys. Painter focuses on media and textures. For Web design, it creates buttons and images better than just about anything.

For all its strengths, I do have a personal problem with all of the palettes the Painter interface makes you juggle. You have a tremendous amount of variables at your control, all of which are necessary in order to simulate the various effects. You may have to adjust 5 slider controls to get the effect of lightly stroking watercolor

Painter: Great program, but needs work in the way objects are selected and masked. It's quite confusing sometimes the way the selection process works. Also needs work with all the clutter.

Painter: OK. So I can paint and do other neat stuff. How on Earth can I get anything real done? Too many palettes, confusing procedures—I was fascinated for about an hour, and then I had to actually get some work done.

**Figure 15.5***Painter from Fractal Design.*

paper with a piece of blue pastel. I admit that with a computer there is no other way to do this, and that if I really want the feel of a brush in my hand, I should put a brush in my hand. I've spoken to other people who don't mind it, so maybe it's just me.

xRES: The All-Purpose Entry

xRES is a program originally created by a small company called Fauve Software. It rose up as a challenger to Photoshop based on the speed of its processing. At the same time, MetaTools (then HSC Software), began distributing Live Picture, also touting their speed advantages. The war was on, and Fauve was the smallest of the competitors in a very competitive market. It wasn't until they sold it off to Macromedia that xRES began to get significant attention as a player in the image editing arena.

You should approach both xRES and Live Picture with a little patience, especially if you've been using Photoshop for a while. There are some new file formats to learn, and some new ways of working to get used to. In xRES, the most important new file format is called an LRG file. LRG files allow xRES to handle very large files quickly, speeding the opening and image editing process. They do their magic based on dividing an image into tiles, and showing only as much information on the screen as is necessary to convey the results. This process is called *ripping to screen*, and it is an effective method employed by both xRES and Live Picture.

I give Painter a 10 for its utility. There's nothing else like it, and it does what it does so damned well. Easily my favorite enabling technology, but what a bizarre and counter intuitive interface for most things. The 4.0 version might be better in this regard; I'm still using 3.1. The manual sucks!

Fast, but it [xRES] has a lot of gaps. The Photoshop-like interface can sometimes be deceiving. Still putting it through its paces and about to add more RAM to get the most out of it.

Stephen Holmes
Graphic Art Computer Lab
Swinburne University of
Technology

The result is that you can indeed open a 500MB file in less than ten seconds. You can rotate it, apply paint to it, and modify it in any number of ways. The catch with programs that use technologies that rip to screen is that they require post-processing after the design is completed. This post-processing procedure is usually not long, and when compared to the time saved in the creative stages, it is a real bargain.

In some ways I find that xRES is not a very focused program...it's almost as if it's searching for an identity. It does offer fast processing of large files, using what it calls xRES mode, but then it also gives another option called Direct mode, where all of the speed gains are stripped away. It is confusing why you would want to use direct mode, unless you just want to avoid the post-processing. Maybe there's another reason (but I'm not sure what it is). So you have new file formats, two modes to choose from, and a whole new interface to learn.

The interface is not too bad, other than the amalgam of floating palettes scattered across the screen. In this way, xRES reminds me of Painter (see Figure 15.6). It seems there are palettes for everything, including a palette for controlling your palettes (just kidding). Photoshop also uses palettes, but somehow manages to make them less of an obstruction. xRES also resembles Painter in the way it offers a wide array of brush and texture options. This points out a real strength of the program. xRES is very strong in the use of paint and textures on a photographic image. The palettes do lend themselves to this task very well, and the capability to paint, blend, and smear pixels is very intuitive. xRES also supports plug-in technology, enabling KPT and other filters to go to work. If I need to do any painting on an image, xRES is where I go.

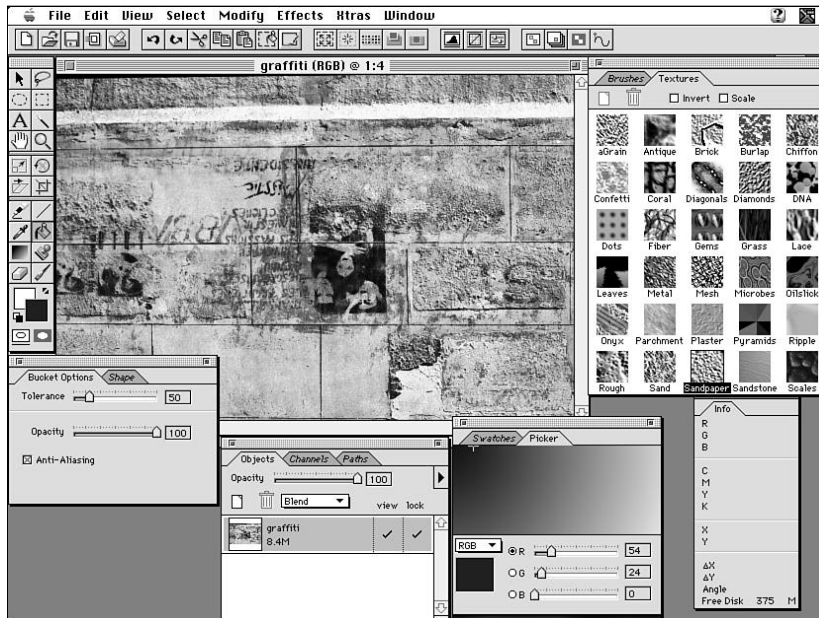

Figure 15.6
The xRES interface

The documentation for xRES needs improvement. The manual does not spend enough time clarifying the differences that make xRES better. Instead it devotes lots of space to how to draw paths with the Pen tool, and what the brush textures do. This is basic info that many users already know. It really needs to deliver strategies for how the program should be used, and how the wide array of features can be focused to specific tasks.

At first, xRES looks kind of like Painter, with features that resemble Live Picture's, with multiple modes, and new kinds of files, and the basic tools of Photoshop. I mentioned before that these programs need to be considered on their own strengths, rather than being compared to anyone else. The irony is that with xRES, its strength is that it compares so well with these other programs. It may not be the best solution for any of the individual areas mentioned, but the fact that it offers so much variety in one package is impressive. If you can only afford one image editing application, make it xRES. It delivers speed, tools, and creative flair, at a very good price.

Live Picture: Image Processing Powerhouse

Live Picture is an example of an application that does a few things very, very well. It manipulates images faster and with more precision than just about any other program. It handles large images quickly, and when it comes to montaging and cutting silhouettes, it stands at the top of the heap.

When it was first released, Live Picture was heralded as a Photoshop killer, due especially to its speed in handling large images. Live Picture has struggled to shed that title, claiming that they do not want to replace Photoshop, merely augment it. They live up to this goal, leaving the other programs to handle the filters and paint effects, whereas LP focuses on image enhancement, masking, and sophisticated type effects.

Well, at least they dropped the price [Live Picture] from \$4,000 to \$600, otherwise I'd never know how this software could integrate with Photoshop. I don't find this as intuitive as Photoshop, but a good auxiliary tool.

Ratings

Live Picture	1	2	3	4	5
Ease of Use					
Great Features					
Coolness					
\$ Value					
Overall Rating					

Live Picture utilizes FITS technology, along with a file format called IVUE, to do its magic. FITS technology handles things a little differently than xRES, but the result is the same. Files open in seconds, regardless of their size, and the post-processing times are so short as to be a non-issue. FITS technology enables LP to support an incredible amount of layers, barely slowing down as the numbers go into the dozens. I have designed images with over 125 layers, while still deftly juggling pixels.

The documentation is solid, the interface is well designed, and the effects are stunning (see Figure 15.7). Live Picture is capable of certain effects that no other program can match. Any creative studio working with large images needs to be using Live Picture.



Figure 15.7
The Live Picture interface.

Photoshop: Hail to the Chief

The history of image editing applications should be divided into two periods, BP, and AP: Before Photoshop and After Photoshop. Before Photoshop, there were various applications available, some of which were very good. There was PixelPaint, Studio 8, Digital Darkroom, and of course, MacPaint. Like dinosaurs fading into extinction, all of these faded away after the comet called Photoshop fell to earth (see Figure 15.8).

I am told that Photoshop got its start as a file conversion program at Industrial Light and Magic, the special effects studio started by George Lucas. This was in the eighties, when graphic file formats were all over the place, and PostScript was all but non-existent. One look at all of Photoshop's Save As file options and this begins to make some sense. Photoshop still provides more file computability than any other image editing application available today.

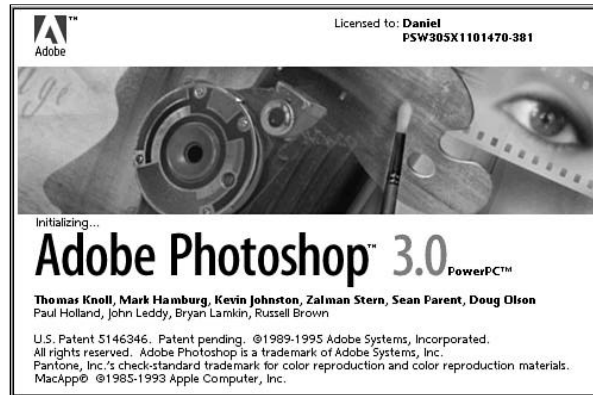
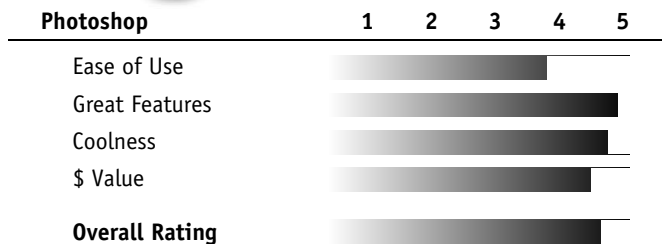

Figure 15.8
The Photoshop splash screen

Ratings



From such humble beginnings, Photoshop has grown into the best overall imaging application available today. It has set most of the standards for what imaging software should be, and stands as the most significant reason for the growth of digital imaging since the Macintosh.

The imaging software field today is a very sophisticated group. For perhaps the first time since it was released, it just may be possible to do without Photoshop, except that none of the challengers have been around for more than a few years. In addition, the full-service applications, such as Color It! and xRES, copy Photoshop so strongly that it's hard to imagine what they would do if they *weren't* copying Photoshop. And finally, Adobe has enough vision, experience, and yes, dollars, to remain at the front of the pack for the foreseeable future. Photoshop is still the incumbent, and while the challengers are strong, the nod for best overall imaging program still goes to Adobe. After all, this is 1996 A.P.

Optimizing Photoshop

The remainder of this chapter looks at ways to optimize Photoshop, making it purr like a kitten.

Making Photoshop go Faster

Open a 50MB file in Photoshop, and watch your machine slow down. Open a 200MB file, and watch it choke. Large files make Photoshop, and the Macs running them, go much too slow for most people. Even with a 10MB file, many find Photoshop's processing speed to be disappointing. Get the fastest Mac available, and you're still likely to complain about the delays in opening and working with files. Although the news sounds bad, there is something you can do about it. This section looks at how to make that sluggish progress bar pick up the pace a bit.

RAM

The most significant thing you can do to speed up Photoshop is to give it more RAM. Give it as much RAM as you can. You cannot give it too much.

You allocate RAM to Photoshop by highlighting the Photoshop icon and selecting the Get Info command from the Finder's File menu (see Figure 15.9). You will notice that there is a Minimum and Preferred setting for how much memory to allocate, but you can forget all that. Set them both the same, the amount being the total amount of RAM in your system, minus 10MB for your system and utilities and stuff.

You might notice the comment in this window saying that Photoshop's memory requirements are reduced by 5,248KB if Virtual Memory is turned on. This is because of how the Mac's new Modern Memory Manager handles native applications. You should turn Virtual Memory on, but do not allocate any disk space to it. This will knock the space needed for the application to around 8MB, allowing more RAM for your files.

If you are the type that wants exact numbers, or you have 256MB of RAM in your system, you may want more specifics than I have given thus far. The specific RAM requirements for Photoshop relate directly to the size of the files you're using. The rule of thumb is that you should use 3-5 times the size of your largest file. Five times the size is preferred, three will get

When creating complex pixel-based images in Photoshop, always use the layer capabilities to the fullest and save a layered version to send to your service bureau along with your flattened image. This will save you from having to do reconstructive surgery halfway into the project due to changes and will allow the prepress people the greatest flexibility when color correcting. If you do so, they will send you a box of Godiva chocolates for the holidays.

Brent Riley,
'lectro design
Evanston, Illinois

Where would we be without Adobe? Keep it up, guys!

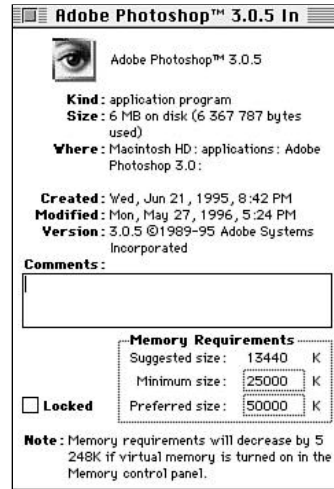

Figure 15.9

Allocate memory to Photoshop in the Get Info window.

you by, less than three can be pretty painful. After the file size has been figured and allocated, you need to give Photoshop more memory for the application itself. This means an additional 13MB or 8MB, depending on whether you're using Virtual Memory.

If you can get this far, and you still have RAM to spare, you may want to create a RAM disk to designate as a scratch disk. A RAM disk is a portion of memory set aside for use as a super fast hard drive. You can create a RAM disk from the Memory control panel, assigning as much RAM as you're able (see Figure 15.10). If you can't create a RAM disk that's at least twice as large as your largest file, then you should just allocate more RAM to Photoshop.

Crop and rotate pixel images in Photoshop, not in page layout or illustration applications. If you don't, it will increase print time and can lead to PostScript errors.

Brent Riley,
'lectro design
Evanston, Illinois

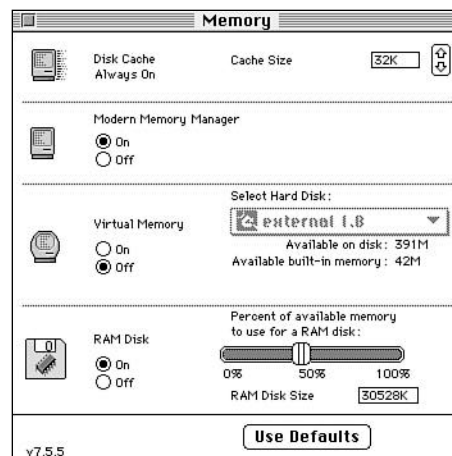

Figure 15.10

Create a RAM disk in the Memory control panel.

Hard Drives

Photoshop uses the free space on whatever hard drive you designate as a Scratch Disk to store file information, such as snapshots and copied items. One way to speed Photoshop is to assign a super fast disk as a scratch disk. Assigning a high speed disk array that uses a Fast/Wide drive with a SCSI adapter card, will dramatically speed Photoshop functions.

Photoshop: Intimidating. A never ending learning curve.

As you use Photoshop, you can track how Photoshop is using memory by keeping an eye on the numbers listed in the lower-left corner of the image window. The far-left number shows how much RAM Photoshop is using for open images, and the right-hand number shows how much memory is left. (Be sure to select Scratch Sizes from the popup menu to see this feature). The amount of memory space can be filled if you take lots of snapshots, or you copy selections or patterns. These are copied to the scratch disk, and take up valuable space. After you are finished with a snapshot or copied selection, select a very small portion of your image, and copy or snapshot that. This will flush the previous larger image out of RAM, and replace it with a smaller image. This should speed up Photoshop a great deal.

Exporting to the Clipboard

If you copy to the Clipboard, and are tired of the progress bar that says Exporting Clipboard every time you leave Photoshop, go to the Preferences section under the Edit menu. Choose General Preferences. Select the More option, and then uncheck the box that says Export Clipboard (see Figure 15.11). This will put a stop to those messages. The messages exist because Photoshop uses its own proprietary Clipboard method, in conjunction with the RAM disk. When you leave Photoshop, it tries to export the Clipboard to the Mac Clipboard. This is usually a waste of time anyway, given that the Mac Clipboard doesn't support most file formats used by Photoshop.

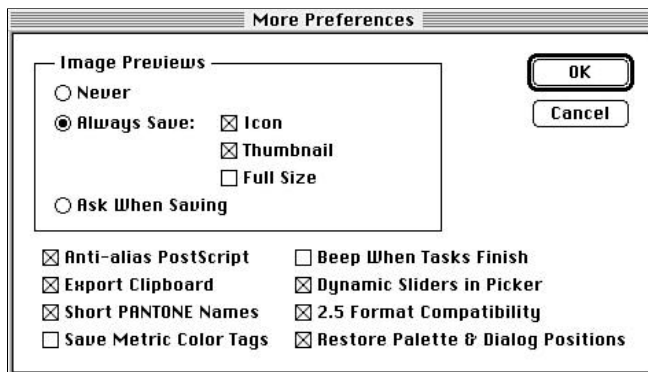

Figure 15.11

Uncheck Export Clipboard in the Photoshop General Preferences dialog box.

Accelerator Boards and Cache Cards

All of the reasons given in Chapter 3's cache card section certainly apply to using Photoshop. The level two cache card can speed up Photoshop by storing the most frequently used commands, allowing the processor to access them in cache instead of memory. Investing a few hundred dollars in a cache card can pay big dividends in the speeding up of Photoshop.

Taking this idea a step further, there are some third party companies that make entirely separate processors devoted only to Photoshop. The processor, called a digital signal processor, handles most of the standard Photoshop commands, and some even dedicate RAM to the DSP as well. The technology itself is solid, and should be considered if memory and a fast drive fail to give you the speed you need.

Filter and Plug-In Enhancements

Just as Apple relied on third party developers to enhance their technology with better hard drives and bigger monitors, Adobe has enabled another group of third party developers to enhance Photoshop with products called plug-ins. Plug-ins are files that stretch Photoshop's capabilities by delivering sophisticated filters, acquiring modules for scanners or digital cameras, and various utilitarian features that make Photoshop that much easier to use.

Photoshop plug-ins are easy to use. Simply drag the item to the Plug-Ins Folder in the Photoshop Application Folder and launch Photoshop. The new feature is available to you at that point, either through the Filter menu, in the Acquire section, or via some other means, depending on what the plug-in does.

Kai and Company

Much of the Photoshop filter craze was started by Kai Krause with the release of Kai's Power Tools in January of 1993. Anchored by Gradient Designer and Texture Explorer, Kai's Power Tools from MetaTools became an instant success. Version 3.0 was released in the fall of 1995, and the set of features continues to expand.

Kai's plug-ins are not just a window within Photoshop where you push a button and get an effect (this is called a One Shot filter). Kai puts more control in filters, such as KPT Spheroid Designer and KPT Texture Explorer (part of KPT 3.0), than any of his competitors. Kai also pays more attention to the interface (see Figure 15.12). Clumsy sliders are replaced by intuitive buttons and handles that allow a greater degree of control. For the digital imaging professional, Kai's Power Tools are not optional equipment.

Kai's Power Tools: The challenge is to manipulate Kai's Power Tools without looking like obvious KPT effects.

Ratings

Kai's Power Tools	1	2	3	4	5
Ease of Use	[Progress bar: ~4.5]				
Great Features	[Progress bar: ~4.5]				
Coolness	[Progress bar: ~4.5]				
\$ Value	[Progress bar: ~4.5]				
Overall Rating	[Progress bar: ~4.5]				



Figure 15.12

The KPT Spheroid Designer controls, part of Kai's Power Tools 3.0.

Convolver

Kai and MetaTools released KPT Convolver in early 1995, and set a new standard for control within a plug-in. Convolver enables complete control over an image's color and texture by modifying something called a *convolution kernel*. Convolver actually has three separate interfaces within itself, each offering expanding levels of control over the image's color and texture. It allows casual exploration, or specific adjustment and tweaking of one component. Convolver even expands its capabilities as you get more proficient. When you have gone through a specific set of tasks, such as using each tool once, or using another 25 times, the program rewards you. A dialog box pops up and you are awarded a red star. In addition, the program adds a new feature, enhancing the task that got you the star in the first place.

Kai's Power Tools: Some wonderful plug-ins that have added to my overall design work. Overly confusing controls due to the company's perceived need to make the interface more "attractive."

KPT Bryce and KPT Vector

Although the other products from MetaTools are not exactly plug-ins, they contribute significantly to the imaging process to the point that I mention them here. KPT Bryce is an amazing landscape generator, which delivers beautiful images of terrain and other worlds. Although it seems targeted at the fantasy illustration market, there are a ton of day-to-day uses where this \$199 program comes in handy. KPT Vector effects is a set of filters for Illustrator and FreeHand that are a mile ahead of any other vector-based filter sets. Final Effects AP is a plug-in set for Adobe Premiere, delivering professional digital video effects on the desktop.

Xaos Tools

Another company with a lot to offer the imaging professional is Xaos tools (pronounced “chaos”). Xaos offers a suite of plug-in and standalone applications, with interfaces second only to Mr. Krause.

Paint Alchemy 2 is a plug-in that might best be described as a *texturizer*. It takes a standard image, and applies a numerous list of effects, such as impressionist stained glass, and many others. If you’re looking for a specific effect in a narrow range, this is a great tool. It is also a good counterpoint to explain the difference between Paint Alchemy and KPT Convolver. Paint Alchemy gives you specific packaged kernel effects, with specific names and predictable results. KPT Convolver lets you loose in the entire kernel space, doesn’t label anything, and lets you find your way. The advantage to Convolver is that you can arrive at results that combine different effects in one shot. This is more difficult to achieve in the Paint Alchemy approach. It is clear though that the task at hand will determine which product is most appropriate, and that both will serve you well.

Xaos also offers a product called Terrazzo, which generates terrific seamless tiles and textures from any image. This is indispensable for Web designers. Their most recent product is called Typecaster, which allows any piece of text to be transformed into extruded 3D type, with lighting and full-color controls.

Design Tip No. 237

For designers working in a digital medium, the key is to avoid falling prey to the limitations of automated functions in graphic software applications. The ability to make successful design decisions rather than have them made for you is the art of overriding default kerning pairs, type, filters, fades, colors, and making your own choices based on your own vision. The software developer in some ways is the Bob Ross of the 90’s, providing the user with calculated strokes, in order for anyone at the mouse to paint a pretty picture. The designer needs to step out of the parameters of the software and shape his or her own vision void of Adobe’s influence.

Jim Mousner, AIGA
TRiBe!
Houston, TX

I think the interface is kinda dorky. I’ve seen cool effects with Paint Alchemy, but I can’t seem to come up with anything useful. Consequently, I don’t use it much.

Creative Plug-Ins From Adobe

Adobe began releasing sets of filters called Gallery Effects shortly after Kai began having his success, Gallery Effects is now up to volume 3, and still going strong.

Ratings

Aldus Gallery Effects	1	2	3	4	5
Ease of Use	[Progress bar from 1 to 4.5]				
Great Features	[Progress bar from 1 to 4]				
Coolness	[Progress bar from 1 to 4]				
\$ Value	[Progress bar from 1 to 4]				
Overall Rating	[Progress bar from 1 to 4.5]				

The Gallery Effects' filters enable you to apply one sort of effect, such as a canvas texture or mosaic effect. They allow you to apply varying degrees of the effect, controlling how much texture or blurring is added, but they do not give the same degree of control as other products mentioned here.

Utilitarian Filters

The filters that follow are designed to make your life easier. They consistently yield predictable results, saving you time and effort.

A great filter set is called Black Box, from Alien Skin software (see Figure 15.13). A year or so ago, all the Photoshop books were touting the use of Photoshop's Duplicate and Calculate functions to create embossed and beveled effects with various images. These effects usually took several steps, and were somewhat complex to follow. Black Box does them all easily, and with a click of a button.

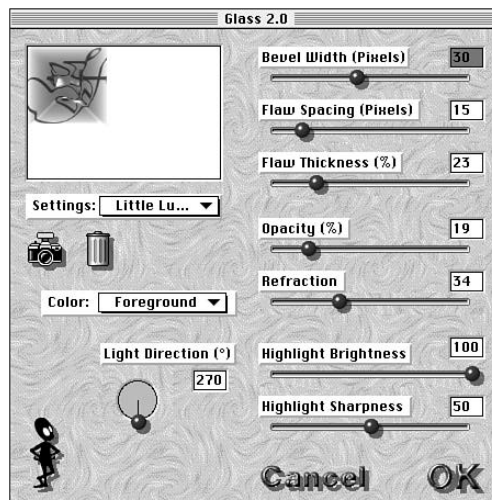

Figure 15.13
The Black Box filter set from Alien Skin software.

A Compendium Of Plug-In Possibilities

Writing plug-ins for Photoshop has become a lucrative software business, as evidenced by the list that follows. The products listed below range from the most creative to the most practical, and will make Photoshop more powerful than ever. Many of these companies offer downloadable demos at their Web sites.

Adobe Systems Inc.

Adobe Systems makes Gallery Effects, a three volume collection of Photoshop filters that apply various texture and lighting effects.

Alien Skin Software

Alien Skin's Black Box offers point-and-click creation of beveled edges, drop shadows, and various other effects.

Andromeda Software, Inc.

Andromeda's plug-ins offer various optical, 3D, and patterned effects.

Cinetic Gmbh

Cinetic Gmbh's Text Wizard enables you to create a variety of text effects with any PostScript or TrueType font.

Cytopla Software Inc.

Cytopia's PhotoLab contains eight color correction filters based on photographic principles, which allow exceptional color control, accounting for film based tints, special effects, and more.

Digital Frontiers

Digital Frontiers' HVS Color converts 24-bit images to nondithered 8-bit images that compress well in GIF format. HVS Color delivers high quality results while keeping file sizes to a minimum.

Eastman Kodak Company

Kodak's Photo CD Acquire module lets you work with Photo CD images in the YCC color space, before you import the images.

Extensis Corporation

Extensis offers Intellihance, which automatically adjusts image tonal parameters, based on your settings. They also offer a piece of freeware called PhotoNavigator, which is a must-have for large images.

Flamingo Bay/ImageXpress

ScanPrep and ScanPrepPro are scanning utilities for the Mac.

Gryphon Software Corporation

Gryphon's Batch It! performs batch image processing functions in Photoshop. It's easy to use, and it really works.

HighWater Designs

High Water's FBI plug-in encrypts images so that they cannot be pirated by others, unless they are using your Macintosh.

Knoll Software

Knoll's CyberMesh converts grayscale images into DXF3D models.

continues

continued

A Lowly Apprentice Production

A Lowly Apprentice offers plug-ins for creating spot-color and HiFi separations, varnishes, bump plates, touch plates, match colors, foil stamping, and other special effects.

MetaTools Software

MetaTools offers KPT 3.0, KPT Convolver, Final Effects AP for Adobe Premiere, and KPT Vector Effects for Illustrator and FreeHand.

MicroFrontier

Microfrontier's Pattern Workshop creates pattern libraries.

Second Glance

Second Glance offers plug-ins for creating process-color separations.

Specular

Specular Collage allows montaging of images in Photoshop, juggling high and low-res images to speed processing.

Total Integration, Inc.

Total Integration offers plug-ins for advanced production work on the Mac. Their products include: SmartXT, a DCS separation and print utility; Epilogue, a sophisticated PostScript Level 2 Interpreter; and FastEdit Deluxe, which allows editing of portions of high res images without opening the whole file.

Xaos Tools

Xaos Tools offers Paint Alchemy for creating painterly effects, and Terrazzo for generating tiled patterns and textures.

See Appendix for more contact information.

Another interesting offering is a product called Intellihance, from Extensis Software. Intellihance enables you to set a specific range of imaging parameters, and apply them with a single mouse click. You can control the tone, saturation, sharpness, and noise of an image. The parameters you set can be useful if you get images from specific sources where you apply the same kinds of effects each time.

Extensis also offers a terrific piece of freeware that every Photoshop user should have. It's called PhotoNavigator, and it helps you move through large image documents. Rather than forcing you to scroll up and down your document when you're zoomed, PhotoNavigator gives you a thumbnail of your image, with a crop designating what is visible on your screen (see Figure 15.14). To go to another area, drag the crop section, and your document image takes you there instantly. This is a great tool...I can't believe these guys give this away.



Figure 15.14
PhotoNavigator enables you to quickly navigate through large image documents.

Another great plug-in utility is a program called FastEdit Deluxe, from Total Integration software. FastEdit Deluxe enables you to open and edit just a portion of a file in Photoshop rather than opening the whole thing. This means that if you want to modify a 5MB section of a 100MB file, you just open the 5MB section, make your change, and replace the section in less time than it takes the 100MB file to open. This one's a lifesaver.

Automating Photoshop

Many of these utilitarian plug-ins approach the task of automating Photoshop. Because Photoshop is such an indispensable production tool, if you could get it to run the same sequence over a folder holding 50 files, you would make a lot of prepress and design people very happy. There are ways to automate Photoshop, and there are ways not to.

AppleScript

AppleScript is the first automation option that springs to mind here. After all, AppleScript is made to automate the Macintosh. The problem with AppleScript has been that while it is pretty easy to learn, Photoshop is pretty complex to automate. There are so many screens and controls in Photoshop, you shouldn't even think of looking to AppleScript to do it, unless you have a hoard of programmers at your disposal.

Photomatic

I give the advice about AppleScript with some degree of conviction, because Daystar Digital *did* have a host of programmers at their disposal, and with all their years of Mac experience, they still couldn't bend Photoshop to AppleScript's will. Daystar's product is called Photomatic, and is based on a simple idea: Have the user perform a command in Photoshop, including pulling down menus and setting sliders, and Photomatic records it as the user does it. The user then replays the script for any number of files, and goes to lunch.

The problem with Photomatic is that it doesn't always work. It is into version 2.0 now, and although some people have gotten it to work OK, others have not even been able to launch it on their Mac (including yours truly). As of this writing, Daystar has not announced any plans to expand the product beyond 2.0, and there is speculation that its future is uncertain.

Batch-It!

Batch-It!, from Gryphon software appears to be the most effective way to automate Photoshop. Batch-It! uses an intelligent grouping of tiles that represent certain Photoshop tasks. The tiles are dragged into a work window, and linked in a sequence (see Figure 15.15). Once a sequence is complete, Batch-It! lets you designate a folder of images to work on, and even gives you control over renaming the set of modified images, preserving the originals.

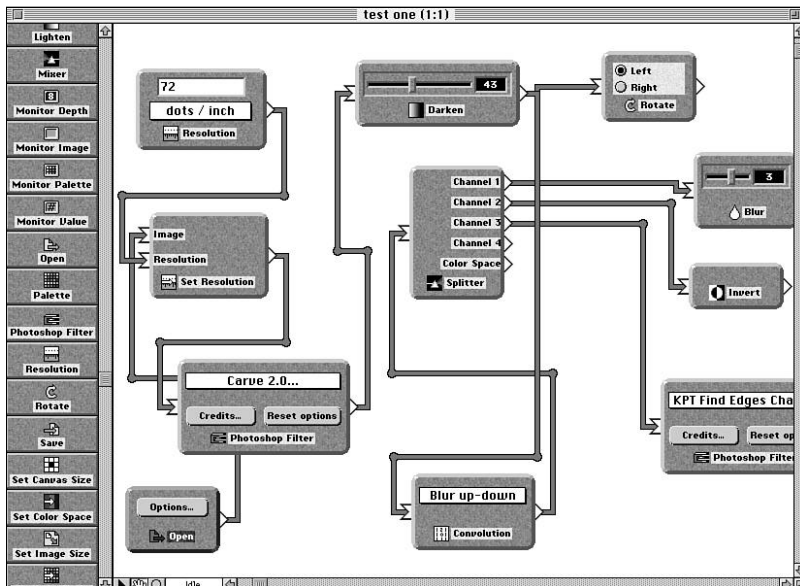

Figure 15.15
Batch-It! lets you link Photoshop tasks to create automated scripts.

In my first hour of using Batch-It! I was able to construct a fairly elaborate script, where I was applying filters to separate color channels within my document, changing file sizes and resolutions, and saving the results. The program also guides you along the way, telling you when a piece (such as Open or Save File) is missing from the equation. The links from tile-to-tile are also intelligent, refusing to allow the linking of functions that could never be executed.

Moving Files from Illustrator to Photoshop

Even though Illustrator is a vector-based application, and Photoshop is bitmap, the fact that they are both from Adobe and share a common EPS format makes this exchange somewhat easier. There are four different methods for moving artwork from Illustrator into Photoshop, each with its own set of advantages.

The best way might be to copy and paste various elements into Photoshop. This enables you to use paths or to rasterize the file and to pick only the components you need. You should do any scaling in Illustrator before copying it over. If you are using Illustrator 6.0, you can drag elements between open windows, from Illustrator to Photoshop.

If you need to position and resize the Illustrator element within the Photoshop file, you should use Photoshop's Place command, located in the File Menu. Perhaps the worst way to open an Illustrator file in Photoshop is via the Open Command. Although Photoshop supports this request while leaving the background of the image transparent, it rasterizes the original Illustrator document. Unless you do a Save As, you will lose your original vector document.

For any of the methods listed here, it's a good idea to save the Illustrator file before starting, and you may even want to duplicate the file if it is at all important.

Calibrating Color in Photoshop

You've optimized your hardware, added the plug-ins you need, and automated your tasks, but what do you do about the color on your screen. Color management on the Mac has been the bane of serious production professionals for years. Getting color to stay consistent from scanner, to screen, to printer has been a Herculean task, although it is getting easier. This section is not going to get too in-depth on color management, because you could do a whole chapter (or book) on that alone. But I will give some tips on how to control color within Photoshop itself.

Gamma Control Panels

Photoshop ships with a control panel called Gamma. If you've never loaded the Gamma control panel, or you've never used it, stop what you're doing now and load it. It is in the Calibration folder, inside Goodies, inside the Photoshop folder.

Gamma refers to the tonal range and contrast shown on your monitor. When you open the Gamma control panel, you will see that it gives you a main tonal bar across the top and individual sliders for each RGB channel, which control black point, balance, and white point values (see Figure 15.16). Moving the RGB sliders changes the color of the screen. This usually isn't necessary, however, moving the slider beneath the tonal bar usually is.

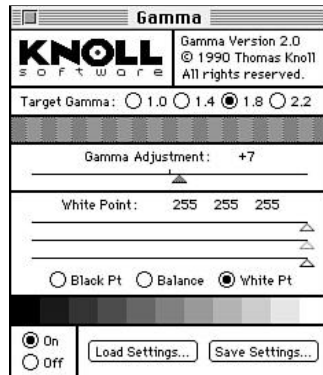

Figure 15.16
The Gamma control panel

Begin by setting your target gamma at 1.8, which is the setting most appropriate for imaging work. Now move the Gamma Adjustment slider, which changes the gamma of your monitor, and is represented by the vertical stripes in the tonal bar. The goal is to make the stripes exactly the same tone, making the tonal bar read as a single value all the way across. This might not be possible, but you need to come as close as you can. When you have done this, your monitor's gamma has been calibrated.

Monitor Prefs

After the gamma has been set, you need to make sure the monitor preferences are set correctly. You open them through the Monitor Preferences command. Located under Preferences, which is under the File menu. You should first look for your monitor type in the popup menu. If it is there, select it, and close the window. If it is not there, or if you need to make custom adjustments, you can enter gamma and color temperature settings in the appropriate spaces.

Printing Inks Set-Up

Now that the general calibration is done, you can fine-tune the specifics. The following procedure will help you calibrate your monitor to reflect the characteristics of a color output device. You are going to create a Printing Inks prefs file that you will load for viewing CMYK images before you print them. Because each color printer has different characteristics,

meaning that the same image looks different depending on where it's printed, you must make a separate prefs file for each printer, and load it as you need it.

The calibration file will be the Ole No Moire file, located in the Calibration folder, where you found the Gamma control panel. This image contains all the proper information for calibrating: flesh tones, CMYK and variants, 50 percent gray, and bright colors. The information in this file is 100 percent accurate, and you should be careful not to change the information by modifying curves or channels. Begin calibrating by printing the file to the device to be calibrated, exactly as it is. (If you use a service bureau for IRIS or Matchprints, have them print it for you there as well.)

Step One

Prop the print up next to your monitor, and look at the differences between the print and the screen. Now open the Printing Inks Setup, located in Preferences, under the File menu (see Figure 15.17). The dot gain is set by default at 20 percent. Changing the number up or down and clicking OK modifies contrast, without changing the color balance. Adjust the Dot Gain until the contrast between the print and screen look pretty close.

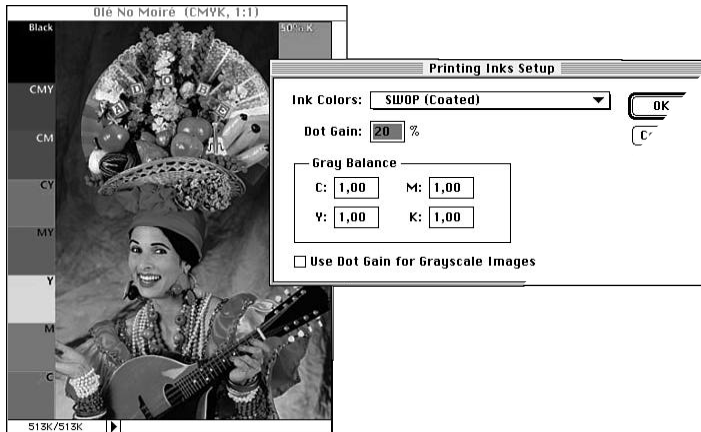

Figure 15.17
The Printing Inks preferences dialog box.

Step Two

In Photoshop, open the Levels dialog, under the Adjust command in the Image menu. Set the popup menu on each CMYK color separately (see Figure 15.18), and move the center sliders for each color until the screen matches the print as closely as possible. **DO NOT CLICK OK AT THIS POINT.** Write down the numerical value at the top center window, reflecting the center slider's position. **CLOSE THE WINDOW BY CLICKING CANCEL.**

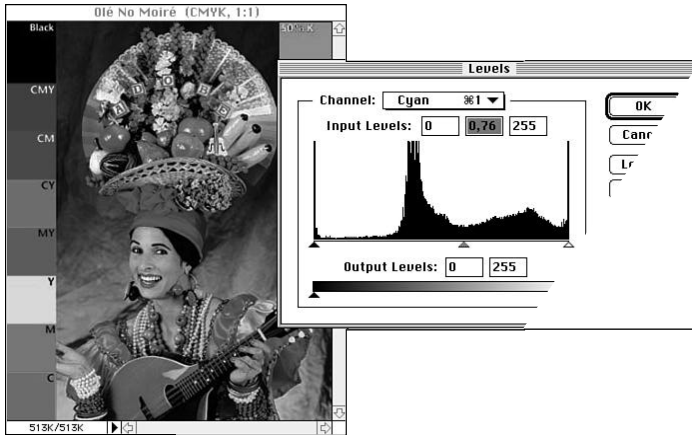

Figure 15.18
The center slider in the Levels dialog.

Step Three

Open the Printing Inks Setup again and enter the values for each color in the Gray Balance section of the window (see Figure 15.19). Click OK and check your results. You can fine-tune further by bumping the numbers for each plate up and down, until the file and the print look close. When they do, click save, name the file after the printer from which it was created, and store it where you can find it.

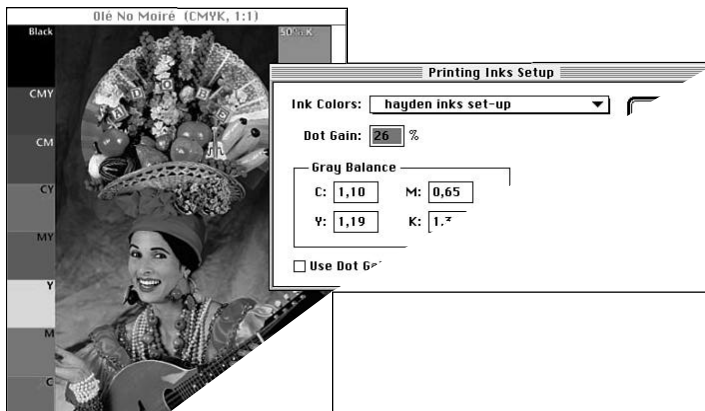

Figure 15.19
Enter the Levels values in the Gray Balance section of Printing Inks Setup.

You can customize further by modifying the colors in the custom section, but you should proceed with caution, because you can really mess up your separation capabilities in Photoshop. Now, just load the prefs file every time you are going to print a CMYK image to that specific color printer. I also have found that loading a profile for a high-end proofing device, such as a Matchprint or IRIS, actually helps when separating a file from RGB to CMYK. Prepress experts may not think it's perfect, but it's a lot better than the standard Photoshop defaults.

16

The Tools Of Illustration

Introduction: The Vector Image

The illustration software applications discussed in this chapter are distinctive in the type of graphics images they generate. The image type is known as vector or object-oriented. The two most popular illustration software applications, Adobe Illustrator and Macromedia FreeHand, are both in this category. I don't want to bore you with technical jargon, but understanding these terms is key to understanding this category of software.

To put it in the simplest possible terms, *vector* means that the image is mathematically constructed from x and y coordinates, with x representing horizontal points and y representing vertical points. Essentially, when you draw a line in one of these programs, you are connecting coordinate points in much the same manner as in a connect-the-dots children's puzzle. Of course, on a computer there are a vast number of dots, but you cannot see them. Object-oriented means the same thing and refers to the character of objects as they are displayed on a monitor.

If you want to know...	Go to...
Can autotracing provide the vector images that I need?	325
How can I better use the Pen tool in FreeHand and Illustrator?	333
What are Bézier curves?	331
What are the advantages of Illustrator?	334
What are the advantages of FreeHand?	342
Are there any good alternative applications?	347
Where can I get good clip art?	341
How can I create 3D art?	348
Do I need special hardware, such as a graphics tablet?	334

In appearance, both on-screen and when printed, vector images have hard, clearly defined edges. Some three-dimensional effects can be achieved with linear and aerial perspective and the use of gradient tones, but a typical vector-image drawing is distinctly flat-looking. This is due to the basic construction of the drawing. Vector-image graphics are made up of separate shapes overlapping each other. When you begin creating such an illustration, you must visualize the image as a conglomerate of assembled parts (see Figure 16.1). Each separate shape has many potential fill and stroke attributes. *Fill* refers to whatever color or pattern is inside the shape, and *stroke* refers to the outline of the shape. Shapes are created by drawing paths (lines) using a variety of specialized drawing tools. Drawing and manipulating paths is the biggest challenge in using illustration software applications.

In this chapter, you will take a look at various aspects of creating and working with vector image illustrations. I hope to give you some candid insights on the software and provide both specific tips and general information. Obviously, I cannot go in-depth on any single software or cover every technique, but you will find the information you need to make a purchasing decision or choose the right software for the job at hand.



Figure 16.1

Vector-image illustrations must be built up with basic shapes and lines. Each shape is separate and overlaps the shapes behind.

Vector and Raster Images

It sounds almost too simple to be true, but there are only two possible types of images on a computer—vector and raster. Vector images are created with drawing software, a general category that includes not only the popular PostScript drawing programs FreeHand and Illustrator, but also sophisticated Unix-based CAD programs and even the drawing module in ClarisWorks. Raster images also are known as bitmapped images, and they are created in painting software applications, such as Fractal Design Painter, or by scanning continuous-tone images, such as photographs. These raster images differ markedly from vector images in both appearance and behavior. Raster images are pixel-based and must be converted to halftones or dithered images when they are printed.

Do I Need to Know How to Draw?

In a word, no, but it helps. Of course, an accomplished artist/illustrator is likely to get much more impressive results than someone whose main contribution to the art world was doodling in the margin while pretending to take notes in English Lit class. If you are of the latter majority, don't despair, for the magic of computer technology is on your side. It is my opinion that most Macintosh software is designed to be used by the largest possible number of people. This is logical and must surely be true. Why would anyone design software that can only be used by trained and experienced artists—a relatively tiny market segment? The illustration software market leaders, Adobe Illustrator and Macromedia FreeHand, are sophisticated graphics tools, and in the right hands, they can produce impressive art. They also have features that make them ideal tools for the daily graphics industry grind where time is money and not much of either can be spent on “art.”

For the artistically challenged, the single most significant feature is autotracing. All major illustration software can automatically trace the outlines of a bitmapped image, providing good results if the template is not too complex. Autotracing is not a panacea. It's like the automatic transmission in a car—it's less work, but you give up a lot of control. Any image that can be scanned is a potential template image, but simple shapes are best. Autotracing scanned photographs often yields an unusable mishmash of shapes that bear little resemblance to the original.

Dedicated Autotracing Software

If you need to get into some serious autotracing, Adobe Streamline is the software for you. Streamline's sole purpose is autotracing, and it is relatively inexpensive. It generally provides better tracing results than the integral autotracing feature in Adobe Illustrator because it has more extensive controls.

Ratings

Fractal Painter	1	2	3	4	5
Ease of Use					
Great Features					
Coolness					
\$ Value					
Overall Rating					

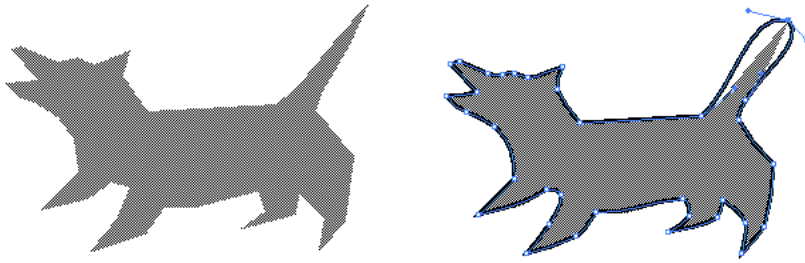
**Figure 16.2**

On the left is a bitmap image before autotracing. On the right, the image is shown autotraced with a 3 point stroke width. The anchor points on the autotraced image can be manipulated in the usual manner (see tip of tail on right).

A competitor to Streamline is Tracer from ScanVec. Tracer also does an excellent job of converting bitmap templates to vector images. On the negative side, Tracer is twice as expensive as Streamline and has been panned in some reviews for requiring an ADB hardware-protection key and having poor documentation.

Ratings

Adobe Streamline	1	2	3	4	5
Ease of Use	████████████████████				
Great Features	████████████████████				
Coolness	████████████████████				
\$ Value	████████████████████				
Overall Rating	████████████████████				

Both Streamline and Tracer work on PICT or TIFF files and provide autotracing controls not found in the built-in autotracing functions of FreeHand and Illustrator. For example, both programs enable you to optimize tracings to reproduce more curves than straight lines and vice versa. Both have a centerline tracing mode that is handy for accurately reproducing outlines. A little experimentation with the controls in these programs is usually necessary, but after you get the hang of it, you can rapidly create vector images from bitmap images.

NOTE

As a teacher in a community college, I've learned a valuable lesson from my students. When I first began teaching computer illustration, I would warn the students against auto-tracing a photograph. "Don't even try to auto-trace a photograph," I would say. Naturally, many of them always did it anyway. Usually, they ended up spending many useless hours trying to make something out of the result. Finally, one semester I made it an assignment. Out of a class of eighteen students, seven of the projects were impressive. These particular students used the autotrace feature of Adobe Illustrator in a controlled fashion on templates made from high-contrast photographs. None of the seven students was a particularly good artist, and because they couldn't draw well, they were highly motivated to make this shortcut work. I learned never to underestimate the power of necessity (as the mother of invention).

Making a Template for Tracing

When a scanned image is to be used as an autotracing template, it's not necessary to use a high resolution. In fact, it's a waste of pixels to use anything higher than 72 DPI. Adobe Illustrator requires the template image to be in the PICT format and can create a new Illustrator file with the image integrated into it. The template image always appears in a shade of gray. After tracing, hide the template image by choosing Hide Template in the View menu.

TIFF is a good format for Macromedia FreeHand template images. To prepare the image for tracing in FreeHand, import it onto the background layer with the Place command. As in Illustrator, the image will appear gray. Lock the background layer and move to the foreground layer to perform the autotrace. After tracing, hide the template image by clicking the hide/show checkmark in the layers palette.

Template images are not just for autotracing. Many professional illustrators use scanned images as templates, but actually use one of the manual drawing tools instead of the Autotrace tool.

PostScript Power

PostScript is an image-processing computer language developed by Adobe Systems, Inc. It is responsible in large part for the success of desktop publishing and illustration, because it enables high-resolution graphics to be printed out on laser printers, imagesetters, and other output devices. Adobe PostScript is pretty much the standard of the electronic publishing industry, and this includes the Adobe Type 1 font technology.

It is the power of PostScript that converts the relatively low-resolution screen images created in Adobe Illustrator or Macromedia FreeHand into high-resolution images on paper, film, or printing plate. Unlike raster images (bitmaps), the final resolution of illustration software graphics is actually determined by the resolution of the output device. This means that an Adobe Illustrator drawing output on a 600 DPI (dot-per-inch) laser printer will have a final resolution of 600 DPI, but the same drawing output on a 2400 DPI imagesetter will have a final resolution of 2400 DPI. This is known as device-dependency, and it is a distinguishing characteristic of vector-image illustrations.

PostScript is an actual language with vocabulary and punctuation rules. For example, a line of PostScript code might read something like the following:

```
128/Adieresis/Aring/Ccedilla/Eacute/Ntilde/Odieresis.
```

This is a single line of code taken randomly from many pages of similar stuff describing an Adobe Illustrator gradient pattern. Some English is used in PostScript, especially at the beginning of a page description file. Adobe Illustrator and Macromedia FreeHand are the most popular PostScript drawing programs for the Macintosh.

The Big Two: Adobe Illustrator and Macromedia FreeHand

It is interesting and amusing to have watched the progress of these two PostScript drawing applications since they were first released in the late 1980s. They have been strong competitors for all these years, leapfrogging each other with new features in release after release. They may finally have reached an impasse of sorts because they both have about the same capabilities. Personally, I think Macromedia FreeHand is slightly superior; however, I'm sure the software developers are constantly busy trying to come up with a blockbuster feature that will blow the competitor away (for a few months, anyway).

In my part of the world (Dallas/Ft. Worth Metroplex), Adobe Illustrator seems to be favored by graphics industry professionals. I don't know whether this is true in other areas or not, but it is somewhat ironic, because the original developers of FreeHand, Altsys Corporation, had their corporate headquarters in Richardson, Texas—a suburb of Dallas. Ah well, I guess the old saying about the prophet being despised in his own land applies in this instance. Altsys is no more, having been absorbed by Macromedia. FreeHand originally was marketed by Aldus Corporation, but Aldus has merged with Adobe Systems, Inc. and the Aldus name was dropped. Adobe certainly didn't need another PostScript drawing program, so FreeHand (and Altsys) was picked up by Macromedia—more irony, I suppose.

Ratings

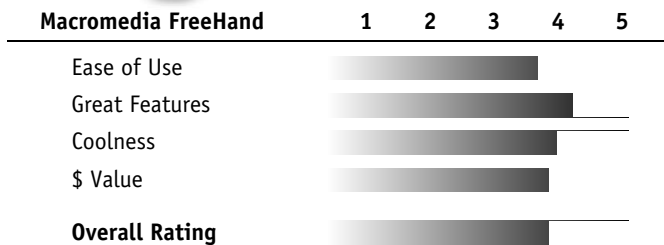

Ratings

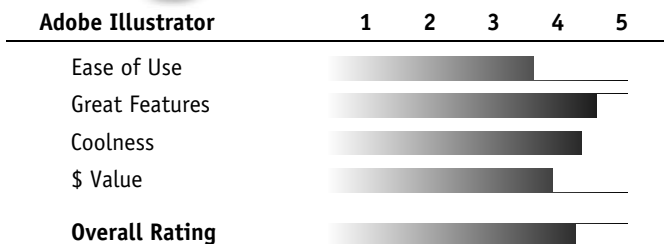

Adobe Illustrator is good software, and I admire Adobe Systems, Inc. as a mostly great company, but I must confess that I think FreeHand is (and always has been) slightly more sophisticated. The two have similar drawing tools, but FreeHand has always had the edge in my mind with its versatile and powerful Bezigon tool. The Bezigon tool creates paths by establishing specific types of anchor points—corner, curve, and connector. When mastered, this tool is much easier to use than the Pen tool pioneered by Illustrator. Of course, FreeHand has a Pen tool also, but the Bezigon tool is my favorite. Both programs have a freehand drawing tool, but I find it the most difficult to use in spite of its intuitive nature. I will examine these tools more closely in subsequent paragraphs.

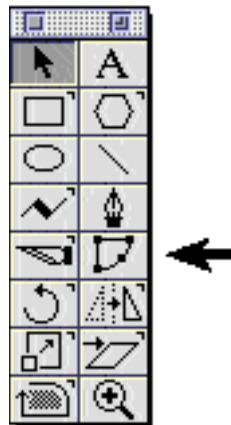

Figure 16.3

Although both Illustrator and FreeHand contain pen tools, many people find FreeHand's BeziGon tool faster and more versatile. The BeziGon tool is located just under the Pen tool in FreeHand's Toolbox.

Both these programs have obvious aspirations to become your all-purpose graphics software. I say this because each new software release seems to incorporate more typographic features than the last. Once again, I feel that FreeHand has always had the edge in type handling, but now they both have virtually the same typographic features as a sophisticated word processor or page layout program. FreeHand even enables you to create multiple separate pages—a feat Illustrator has yet to duplicate, although I won't be surprised if it happens. I have heard of graphics designers who use nothing but Illustrator or FreeHand as their main software application, creating logos, business stationery, and print ads. These programs are still intended primarily as illustration tools, however, and Adobe PageMaker and QuarkXPress do a much better job at page layout.

Most agencies in Australia prefer Illustrator to FreeHand (especially after all the bugs in FreeHand 4.0) so I had to learn it again. I HATE the paint style box; it takes up far too much screen real estate. Why can't they port the Photoshop palettes? And it took them until version 6.0 to add a decent dimensions palette! Another thing that bugs me is that most of the world is now metric, yet Illustrator will still default to the nearest 1/72 of an inch.

Stephen Holmes
Graphic Art Computer Lab
Swinburne University of
Technology

The bottom line on FreeHand and Illustrator is that they are more alike than they are different. You really cannot go wrong with either one, and they are even compatible with each other. If you are using FreeHand you can export your drawing in the Illustrator format, and FreeHand can easily open an Illustrator document. It's difficult to choose between the two, but FreeHand has many advantages. For a good feature-by-feature run-down on the two, see the review of Adobe Illustrator 6.0 by Deke McClelland in the April 1996 issue of *Macworld* magazine. Mr. McClelland also has reviewed Macromedia FreeHand in the February 1996 issue of *Macworld*.

Let's Be Objective

Imagine that you are from another planet in another solar system and you have just arrived on earth for the first time. You are interested in buying a computer and an illustration software application to take back to your home world, and you're not planning to be back this way any time soon. Due to certain astrophysical parameters you have only 24 hours to make your choices before you must return to your own part of the universe. You decide there are just too many variables and pricing schemes on the Wintel (Windows-Intel) side, so you pick a top-of-the-line Macintosh, which you get dirt-cheap from a mail-order house in L.A. The software choice is a little harder though, so you make appointments with sales reps for Adobe, Macromedia, and Deneba. They each have fifteen minutes to show you Illustrator, FreeHand, and Canvas, and you will then purchase one of them on the spot and immediately depart. My guess is that you would pick Deneba Canvas without hesitation.

Deneba Canvas is good software. So why don't more Macintosh people use it? On a feature by feature basis, it has as much and more to offer than either FreeHand or Illustrator. Still, it seems one does not encounter it in professional graphics circles as often as the other two. Perhaps, like CorelDRAW!, it's seen as more of a Windows creature, and Mac people just cannot overcome that stigma. If Canvas's lack of popularity is due to prejudice or Mac chauvinism, it's a real shame because this software deserves a closer look. Canvas, however, is something of an all-purpose illustration program with powerful tools for drawing and painting. Be sure to read the section on Deneba Canvas in this chapter before making a decision.

NOTE

Paths, Strokes, and Lines: All three terms mean the same thing, really. If one must split hairs, a path is the mathematical vector that defines an outline and stroke is the width, color, or pattern of the path. Of course, the term weight is also used instead of width. Line refers to a visible path. I hope you will forgive me if I use the terms indiscriminately.

Drawing with a Bar of Soap (the Mouse and the Bézier Curve)

One thing common to all good illustration software is the Bézier curve (see Figure 16.4). A Bézier curve is a line that can be precisely flexed in any direction by dragging control points on the line. Drawing with Bézier curves feels strange to traditional artists because it's a rather restricted way to draw. It is difficult to sketch freely with Bézier curves, and many artists do not adapt to illustration software applications for that reason. Of course, that precise, highly controlled path is the perfect solution for drawing with a standard mouse—a drawing tool about as precise as a bar of soap. Even a trackball mouse is little better. Some artists and illustrators find succor in a stylus and graphics tablet, but many fine vector-image illustrations are still done with that little bar of soap.

For the artist accustomed to the spontaneity of drawing and painting with traditional pens, pencils, brushes, and so on, even a graphics tablet and stylus leaves something to be desired. Painting programs lend themselves a little more to the quick sketch approach, but vector-image illustration programs require an attitude adjustment. Even when Bézier curve paths are created in autotrace operations, the paths themselves must often be manipulated and edited in various ways. Autotracing, for example, typically creates a surplus of anchor points, and many of them may have to be removed if the path is to be changed in any way.

The freehand drawing tools in Illustrator and FreeHand have something of the feel of sketching, but they are difficult to use with anything but a stylus and tablet. Besides, the result is still a set of Bézier curve paths that must be somewhat rigidly controlled. In Adobe Illustrator, the primary Bézier curve creation tool is the Pen tool. Macromedia FreeHand has a Pen tool also, but the FreeHand Bezigon tool is superior in many ways. See “Tips for Using the Pen Tool” and “Forget the Pen Tool—FreeHand’s Better Way” for more information. Deneba Canvas takes a different approach altogether, and some newer drawing programs, SmartSketch and LightningDraw GX, promise to deliver more of a spontaneous, sketchy feel. These are discussed later in this chapter.

I started with FreeHand V2.0, lived through V4.0, just, but changed jobs and had to learn Illustrator (gnashing of teeth). V5.0 Hallelujah! V5.5 even better! The Inspectors are the best thing since sliced bread; even Adobe copied the concept in SiteMill! And being able to send EPS files that a client can't alter is reason enough to buy this program. Now all we have to do is come up with a way to stop others from horizontally scaling your logos and illustrations to “make them fit” into their crumbly newsletter/brochure/work that the client is too cheap to get you to do properly and gives it to his secretary instead. Don't you just hate “desktop publishing”?

Stephen Holmes
Graphic Art Computer Lab
Swinburne University of
Technology

Essentially, the Bézier curve is an analogy to the mathematical vector analysis on which these programs are based. Illustrations are created mostly from shapes that are described as complete paths. That is, the paths have no loose ends—the end of a path must join its beginning to form a complete shape. This is necessary if the shape is to be filled with color or pattern. Strictly linear elements (lines with unconnected ends) are certainly used in vector-image illustrations, but the majority of elements are the closed shapes containing colors and patterns. The Bézier curve paths can be flexed and reshaped by dragging the anchor points and control handles associated with them (see Figure 16.4). Dragging an anchor point actually repositions the path. Dragging a control handle flexes the curve and changes its direction. Straight lines are just Bézier curves without control handles, and they can be easily converted to full Bézier curves.

In Figure 16.4, the tiny squares are anchor points. Anchor points associated with curves have control handles attached to them. Control handles are represented by lines with round dots on the ends. Anchor points and control handles on Bézier curves in Macromedia FreeHand differ slightly in appearance but have the same functions.

Be concise but thorough when marking up your job to send out. Too much info and they might not read it. However, don't assume they will know everything, no matter how obvious it may seem to you. Put your name and phone number right on your markup so prepress people will actually give you a call if there are problems or questions about your digital files.

Nancy Anderson,
Liska and Associates
Chicago, Illinois

Figure 16.4

The Bézier curve is a line that can be manipulated with control handles. This is an example of a Bézier curve path from Adobe Illustrator.

Illustrator's Pen tool is fantastic. However, the interface for paint styles is a little clumsy and takes getting used to. The support for TIFFs in 6.0? About time! The type features are very nice (6.0), and the new path functions are cool. Drag and drop integration with PageMaker and Photoshop is a major plus.

Tips for Using the Pen Tool

Both Adobe Illustrator and Macromedia FreeHand have a drawing tool represented by a pen nib icon. This is the Pen tool, and it provides an interactive way of creating curves and straight lines (paths). The Pen tool works pretty much the same way in both applications. It is interactive in the sense that when the tool is dragged, a curve control handle is created, and it flexes and changes the direction of the curved path while the path is actually being drawn. With a little practice and by following certain simple rules, the path can be made to go precisely where you want it.

Rule #1. A curve needs only two anchor points. The anchor point is the handle that appears on a path as opposed to the control handles, which stick out from the anchor points (see Figure 16.4). The control handles associated with the anchor points at each end of a curve are all you need to make that curve go where you want it. Of course, the anchor points themselves can be dragged to change the length of the path segment between them. The trick is to try to analyze the number of curves a given shape requires and draw it more efficiently with fewer anchor points. For example, there is no need to place an anchor point in the middle of a curve.

Rule #2. Keep the path going in the same direction. This seems obvious to some new users, but others tend to get confused and end up with kinks in the line. The secret is to always drag the pen in the same direction in which you started the path. If you tend to draw clockwise, then always drag the pen clockwise to make a curve. Don't start off clockwise and then suddenly start trying to draw counterclockwise on the same path. Completely separate paths, however, may have different directions.

Rule #3. Draw complete paths made up of connected segments. If you want to draw a complete shape that will be filled with color or a pattern, the path around the shape must be continuous. This should not be a problem unless you switch to another tool before completing the shape, because the Pen tool automatically starts a new path segment each time you click or drag with it. The main thing to remember is to try to complete any shape you are drawing before attempting any other operation because you may end up creating a series of independent line segments instead of one complete path, and this will cause problems when you attempt to fill the shape. You can reestablish contact with the last anchor point and continue the path if you know how, but the technique is different from software to software. See the user's manual.

Rule #4. When beginning a curve, drag the Pen tool about one-third the total distance of the curve. In effect, this means that the control handles should extend about one-third the distance to where you expect to place the next anchor point.

Rule #5. While drawing with the Pen tool, use the ⌘ key to access the Selection tool. This enables you to make modifications to your path as you draw, without actually having to switch back and forth in the tool palette. Take care to continue the same path when you resume drawing. When drawing, try to stay in the drawing tool and use keyboard shortcuts to access other operations such as scrolling and zooming. Fortunately, FreeHand and Illustrator use some of the same shortcuts: Spacebar for the Grabber Hand (scrolling) and ⌘ + Spacebar for the Zoom tool (⌘ + Option + Spacebar for negative zoom).

Do You Really Need a Graphics Tablet?

Most of us are comfortable writing and drawing with a pen or pencil, and the graphics tablet and stylus provide something close to that same sensation. Many illustrators who have developed great skill with traditional drawing and painting tools find the graphics tablet a must.

I think a graphics tablet and stylus are good for anyone using painting software, but I'm not so sure one really needs it for illustration software. I don't think it helps that much with the Bézier curves and basic geometric shapes. Ultimately, it's a highly personal choice—no one can accurately say whether it's right or wrong for you. Try one at the computer store.

Adobe Illustrator: The First on the Scene

Being the first to do something has its rewards, but it's always tough to stay on top. Adobe has managed to do so with its Illustrator drawing software. I haven't seen the sales figures, but it's obvious that Adobe Illustrator is still highly successful in the electronic publishing marketplace, sharing the limelight only with its main competitor, Macromedia FreeHand. The relative market positions of Illustrator and FreeHand are hardly relevant to us, and you will not be seduced by slick advertising, right? You want powerful features coupled with ease of use and no nasty little surprises. Well, Illustrator fills the bill for the most part.

There was that unpleasantness with the gradient fills in version 5.0 not working with some PostScript processors, but that kind of problem is to be expected from time to time, and Adobe has the resources to address such issues quickly with bug fixes and new versions. My only complaint concerns Adobe's lack of attention to its Windows version, which seems stuck in limbo at version 4.1—a version number that never even existed on the Macintosh platform. For many of us, cross-platform compatibility is an important issue, and I have had several occasions to wish that Adobe would catch up with a new Windows version.

Illustrator is relatively simple software to use. There is a clear and straightforward methodology in its user interface that has remained virtually unchanged since the first version. For example, Adobe has never provided a duplicate or clone menu command, relying instead on a simple Option key + drag method to make copies of an object. Let's take a brief look at some of Illustrator's main features.

Drawing Tools

The Illustrator art board can be configured as a single full page or tiled image areas with a maximum size of 120 inches × 120 inches (see Figure 16.5). The Pen tool is Illustrator's main drawing tool and the most difficult to master. It creates straight lines and curves. Other drawing tools are provided for brush stroke/calligraphy, freehand, autotracing, and geometric shapes (see Figure 16.6). The Pen tool creates straight lines and curves.

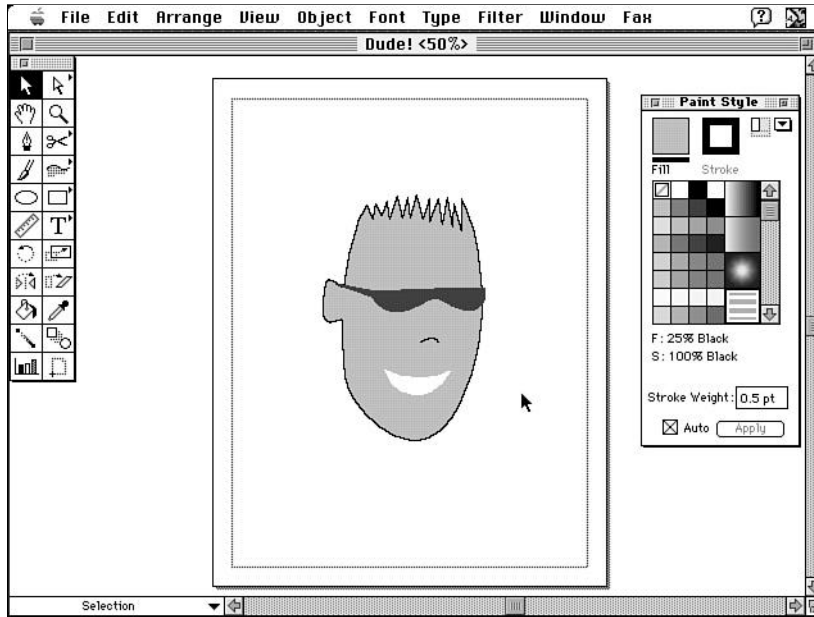
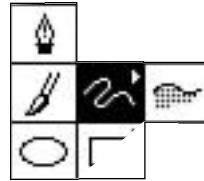

Figure 16.5

The Adobe Illustrator art board displayed as a single 8.5 × 11 inch page. The Toolbox is shown on the left; the Paint Style palette on the right. The Paint Style palette can be configured in several ways.

Figure 16.6

The drawing tools are clustered together in the Toolbox. The Pen tool looks like a pen nib. Below it are the Brush tool, the FreeHand tool, and the Autotrace tool. Next are the Oval tool, Rectangle tool, and Rounded Rectangle tool (not shown). Some tool icons are located in pop-out sections of the Toolbox.



The Brush tool creates what looks like variable-width paths but is in fact creating filled shapes. These shapes can be altered after drawing by manipulating the anchor points and control handles on their outlines. A calligraphy effect can also be achieved with the Brush tool (see Figure 16.7).

The FreeHand tool creates freeform paths and is somewhat difficult to control without a graphics tablet and stylus. Its purpose is to draw shapes that might be too complex to draw with the Pen tool. See Figure 16.8 for a comparison of typical shapes drawn with the Pen tool and the FreeHand tool.

**Figure 16.7**

The Brush tool creates broad strokes and can be configured for a calligraphy effect.

The Autotrace tool can be used to automatically trace bitmap images. Illustrator is able to open a PICT file as a bitmap template for autotracing. The template image appears in the drawing area as a monotone gray bitmap and becomes part of the Illustrator file. The template image can be hidden when necessary but cannot be selected or altered. Autotracing is accomplished by choosing the Autotrace tool and clicking the edge of the template image. Illustrator creates a path by following the edges of the pixels in the bitmap. There is little control over the accuracy of the tracing. User preferences can be set that enable the Autotrace function to make smoother curves and bridge minor gaps in pixels, but this tool is actually rather primitive.

Simple geometric shapes are drawn with the Oval, Rectangle, or Rounded Rectangle tools. Adobe Illustrator provides plug-in tools for drawing other types of shapes such as stars, polygons, and spirals. Additional plug-ins perform all sorts of specialized operations on existing shapes.

Selection Tools

Illustrator has three selection tools: the Selection tool, the Direct Selection tool, and the Group Selection tool (see Figure 16.9). The Selection tool is used primarily to select entire paths so that a shape can be moved, transformed, or deleted as a whole. The Direct Selection tool selects individual anchor points or line segments and must be used for Bézier curve manipulations. The Group Selection tool can sub-select elements in a set of grouped objects.

**Figure 16.8**

The cat is drawn with smooth curves and straight lines by using the Pen tool. The ball of twine would have been very tedious to draw with the Pen tool, so the FreeHand tool was used.

**Figure 16.9**

The selection tools are (from left) the Selection tool, the Direct Selection tool, and the Group Selection tool.

Transformation Tools

After the drawing tools and selection tools, the next most important set of tools are the Illustrator transformation tools. They are the Rotate tool, the Scale tool, the Reflect tool, and the Shear tool (see Figure 16.10). These tools perform the operations described in their names with either of two methods. An object can be manipulated directly with the tool or a dialog box can be used. The transformation tool dialog boxes can be displayed by double-clicking a tool icon after selecting the object to be transformed. Dialog box operations always offer more precision than manual operations and have other advantages, such as making copies and transforming patterns. The Scale dialog box, shown in Figure 16.11, is typical of the Illustrator transformation dialog boxes.

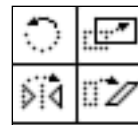
**Figure 16.10**

The Illustrator transformation tools are clockwise from upper-left: the Rotate tool, the Scale tool, the Shear tool, and the Reflect tool.

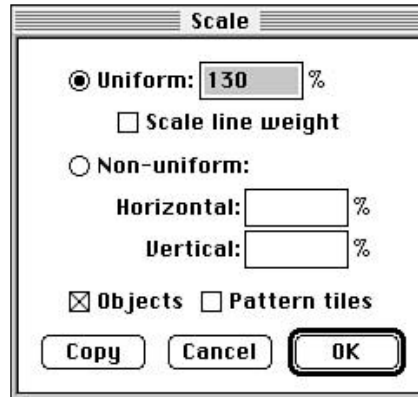

Figure 16.11

The Scale transformation dialog box scales objects uniformly or non-uniformly and provides controls for scaling line weight and pattern fills. Similar dialog boxes can be used to rotate, reflect, and shear objects.

The Paint Style Palette

A key feature of any illustration software is its capability to define line weights and styles and fill shapes and lines with color and patterns. In Adobe Illustrator, the Paint Style palette is the command center for these operations (see Figure 16.12). In this palette, two main icons represent fill color or pattern and stroke color or pattern. (A line is called a “stroke” in Illustrator.) Default colors and patterns are displayed in a color swatch area that can be modified by deleting or adding colors. Process colors, custom colors, color matching systems (Pantone, and so on), and patterns can be accessed through the Paint Style dialog box. Custom colors, patterns, and gradients can be created in separate dialog boxes. Line weight is assigned via a simple numerical field that defaults to points but accepts inches and millimeters. Illustrator provides numerical fields for dashed lines rather than a menu of styles as found in other drawing applications. This method has the advantage of giving the user greater control over the dash and gap widths.

Plug-In Filters

Another feature of interest in Adobe Illustrator is its use of plug-ins to expand the functionality of the software. The plug-ins are filters used to perform a wide variety of actions. There are, for example, plug-in filters for creating arrowheads, drop shadows, calligraphy effects, and special shapes, such as polygons, stars, and spirals. Distortion plug-ins, such as Roughen and Twirl, can create bizarre and interesting variations on a basic shape (see Figure 16.13). These are only a smattering of what’s available. As is the case with its sibling Adobe Photoshop, Illustrator can utilize third-party plug-ins.

Making a Fill Pattern

One of the most fun things to do in Adobe Illustrator or Macromedia FreeHand is to make a custom pattern that can be used to fill any shape. Sometimes known as “tiled” fills, this type of pattern can be made from any object you can draw. I like to think of it as wallpaper or gift-wrapping paper design. The procedure is very simple in both FreeHand and Illustrator, involving little more than selecting an object or group of objects and converting to a fill pattern. This is done in the Pattern dialog box in Illustrator and the Tiled mode of FreeHand’s Fill Inspector palette. Space between the repeating design elements is controlled by including an “invisible” rectangle or square with the element when it is converted to a pattern. FreeHand’s Tiled fill mode is a bit more sophisticated than Illustrator’s, because it provides controls for changing the angle, scale, and offset of the pattern.

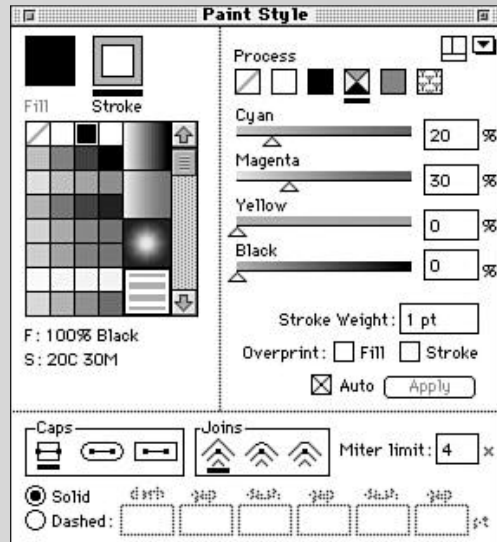

Figure 16.12
Adobe Illustrator’s Paint Style palette controls all fill and line operations.



Figure 16.13
A simple cartoon drawing can be drastically altered with Illustrator plug-ins. In this example, the Tweak, Twirl, and Roughen Distortion filters were used on the basic drawing to create the image on the right.

Typographic Features

Illustrator's basic typographic features are consistent with the standards set by page layout and word processing software applications. Illustrator, however, is primarily a drawing program, and I feel it's unwise to rely on it for page layout and word-processing functions. Software like Adobe PageMaker or Microsoft Word is much faster and better at handling text than Illustrator. It is true that Illustrator has sophisticated typographic features, and some people use the program for advertising layouts or business stationery, but it cannot be used for multiple page documents, and all the text handling seems slow and clunky.

Special Type Effects

Of more interest to artists and illustrators is Adobe Illustrator's capability to treat text in special ways. The text on a path feature is representative and one that is very useful in creating logos. Illustrator can automatically bind text to any path on the art board by simply positioning the Type tool on the path. When bound to the path, the text can be moved along the path by dragging it with the Selection tool (see Figure 16.14). Illustrator can also flow text inside shapes and convert PostScript fonts to outline form. The latter is useful when distorted or stylized letterforms are needed for artistic purposes (see Figure 16.15).

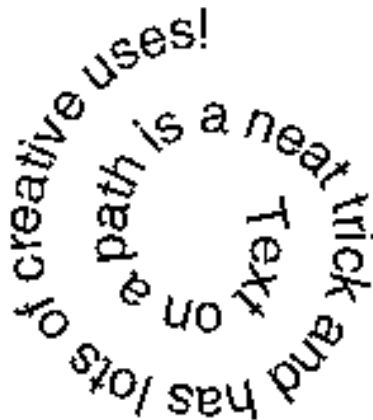

NOTE

Adobe Dimensions is 3D effects software that works with Adobe Illustrator files. It is also a PostScript drawing program with 2D drawing tools similar to Illustrator's. The big difference is that Dimensions has Extrude and Revolve commands for turning 2D objects into 3D objects. Colors can be specified for object surfaces, and you can add multiple light sources. Because it works only with PostScript blends, Dimensions is not meant to compete with bitmapped 3D programs. It cannot add the textures and photorealism typical of 3D programs, such as Pixar Typestry or Ray Dream Designer.

Figure 16.14

Text can flow along any path created in Adobe Illustrator.

**Figure 16.15**

Letters converted to outline form can be modified as if they were drawings.

The Clip Art Alternative

Clip art is a venerable institution in newspaper advertising departments. Newspapers often subscribe to clip art services and consequently receive monthly installments of clip art images representing every conceivable subject of possible use in the daily grind of cranking out space ads for car dealers, furniture stores, and so on. In fact, large manufacturers often provide custom clip art to newspaper advertising departments. A large company often will retain an advertising agency to create “ad slicks,” a form of clip art that consists of print ad shells to be used in local newspapers and magazines. Local merchants in small towns frequently take advantage of these advertising programs instigated by the corporate office.

These days, much clip art is electronic, but printed clip art is still around. Of course, the name “clip art” refers to the act of clipping an image from a printed sheet and pasting it down on the layout board. Electronic clip art is incorporated into electronic page layouts in software like QuarkXPress and Adobe PageMaker. Electronic clip art can be obtained in several different file formats, including EPS and other vector-image types. Image Club Graphics, a division of Adobe Systems, Inc., is a well-known supplier of good clip art. Check them out on the World Wide Web:

<http://www.adobe.com/imageclub/>

or call 800-387-9193 to get their catalog. Although Adobe Illustrator has never done so on either platform, most illustration software developed for the PC/Windows environment includes large clip art libraries. Now it’s happening on the Macintosh side. The recent upgrade of Macromedia FreeHand for the Mac includes such a library—10,000 clip art drawings.

Clip art is a controversial subject among graphics designers and illustrators. Some think it’s OK, but others hate it. It’s a matter of aesthetics and snobbery. Traditional clip art can be incredibly sophisticated and beautifully rendered. Today, mainstream electronic clip art is also quite sophisticated, but a lot of really bad stuff was broadcast in the late 1980s. Ironically, it’s the very slickness and hyper-sophistication of clip art that is objectionable to some designers. Clip art, because it must be generic and multi-purpose, seems cold and soulless. The snobs among us would not be caught dead using clip art—you never know who else might be using the same clip art! (I must confess to identifying mostly with the snobs but will also admit to having used clip art in an emergency—more than once.)

Macromedia FreeHand: Robust Features

In a world of flashy software, it's difficult to make a choice. Reading reviews and listening to the advice of others about mainstream software doesn't always help, because one person's dream program can be another's nightmare. People can be chauvinistic about their software, too. I once had a student drop out of my QuarkXPress class complaining that I favored Adobe PageMaker. (Gee, is it that obvious?) This condition seems particularly rampant among the less-informed, and I vaguely remember going through it myself. Now that I'm among the cognoscenti, I can recognize the virtues of all good software, and this leads me (at last!) to the redoubtable Macromedia FreeHand. It is an excellent illustration software application that never quite seems to get the better of its archrival, Adobe Illustrator.

Compared feature by feature, they are very similar, except that FreeHand's features are a little more robust. The downside of that is that the complexity of some features in FreeHand make it intimidating. Take, for example, the user interface itself (see Figure 16.16). If you are utilizing many of its features, FreeHand clutters the work area with a bewildering array of palettes, and some people find that scary. And then there's that weird Bezigon tool! Adobe Illustrator looks so much simpler in comparison.

When you get past these little barriers, however, FreeHand is fast and efficient. In Illustrator, for example, you have to use the Scaling tool to enlarge or reduce something, but in FreeHand, you just grab a handle and drag to scale the object. In Illustrator, you have to use the Delete Anchor Point tool to remove an anchor point from a path; in FreeHand, you merely select the point and hit the Delete key. Little things like this make a big difference to me. Here is an overview of the main attractions to encourage you to take a closer look.

Forget the Pen Tool—FreeHand's Better Way

I remember when FreeHand didn't have a Pen tool. Instead, it had four separate drawing tool icons called the Connector tool, the Corner tool, the Curve tool, and the Combination tool. The Combination tool worked in a manner similar to the Illustrator Pen tool, but the other three were truly innovative. They created specific types of anchor points with path segments that behaved in specific ways. I thought the tools were really more intuitive than Illustrator's Pen tool, but they baffled a lot of people who were already accustomed to the Pen tool. Although the Combo tool worked perfectly well, FreeHand eventually got a Pen tool of its own (no doubt due to pressure from the marketing department), and the three specialized tools evolved into one—the Bezigon tool (see Figure 16.17).

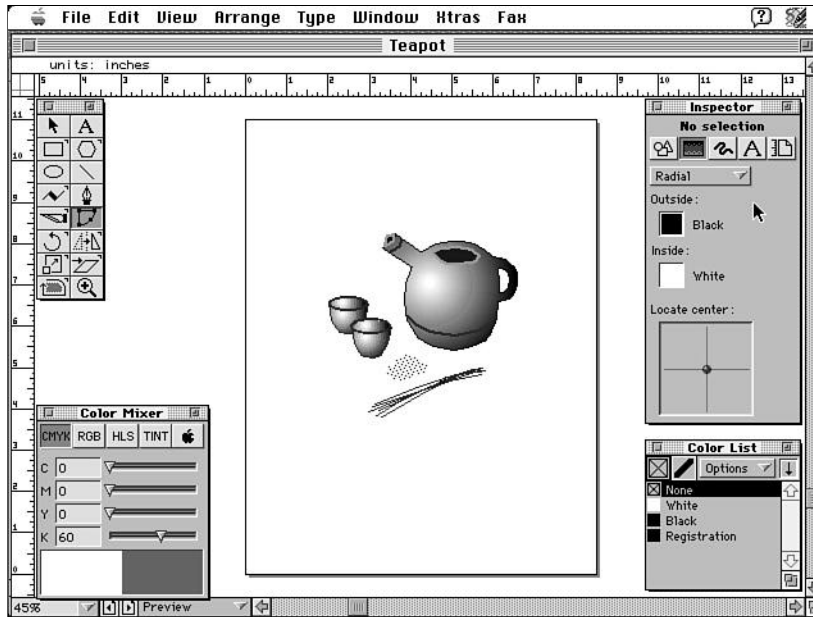

Figure 16.16

FreeHand's many palettes can overwhelm a small display screen, but they can be rolled up like window shades when they're not needed. The Inspector palette (top right) is the main command center.

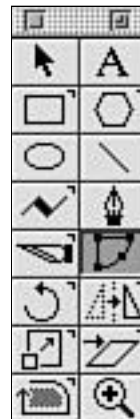

Figure 16.17

Macromedia FreeHand's Toolbox contains the unique Bezigon tool (just underneath the Pen tool).

When used with a template, the Bezigon tool is a marvel, because you can accurately trace the image very quickly. Clicking with the Bezigon tool creates a corner point; holding down the Option key and clicking makes a curve point; holding down the Control key and clicking creates a connector point. The Bezigon tool also can be used in conjunction with the Inspector palette to modify each anchor point as it is placed, but using the keyboard is much faster.

Corner points made with the Bezigon tool are the same as those made with the Pen tool, but the other two modes are completely different. With the Pen tool, a curve only needs two anchor points—one at each end of the curve segment. The Bezigon tool, however, requires an anchor point at the apex of the curve in addition to anchor points at each end of the curve segment (see Figure 16.18). The anchor points at each end of the curve segment do not have to be corner points. They can be corner or connector points, depending on the shape being drawn.

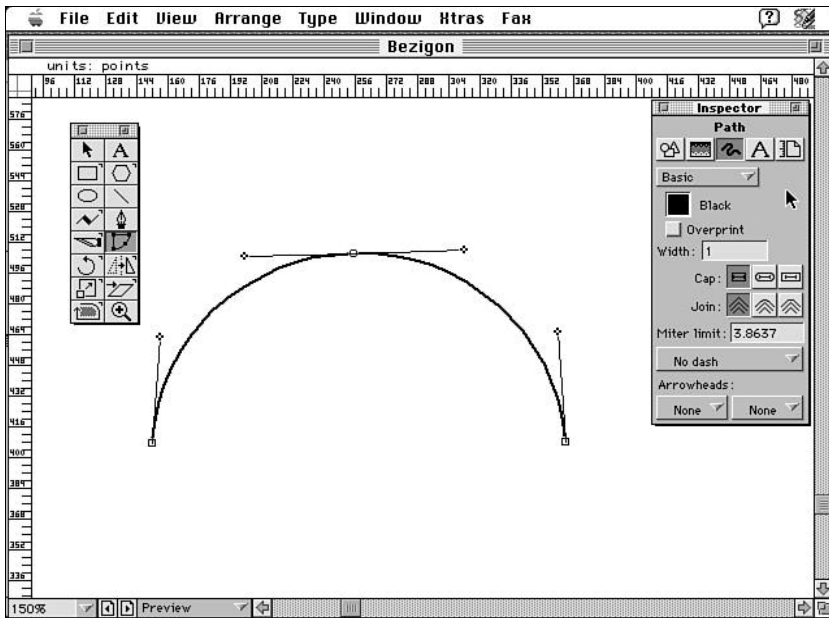

Figure 16.18

This curve drawn with the Bezigon tool has corner points at each end of the path segment and a curve point at the apex of the curve.

The connector points create a smooth transition from straight line to curve and vice versa. Bezigon anchor points can be identified by their shape. Corner points are square; curve points are round; and connector points are triangular. With the Bezigon tool, you have to think ahead because each anchor point defines the path segment behind it. This can be a little disconcerting for beginners. If, for example, you are drawing a curve with the Bezigon tool, the path does not actually become a curve until you make the anchor point at the end of the curve segment (see Figure 16.19).

The Inspector Palette

With the exception of the Bezigon tool, FreeHand's other drawing tools and its transformation tools have a great deal of similarity to Illustrator's, so we'll take a look at some other unique features.

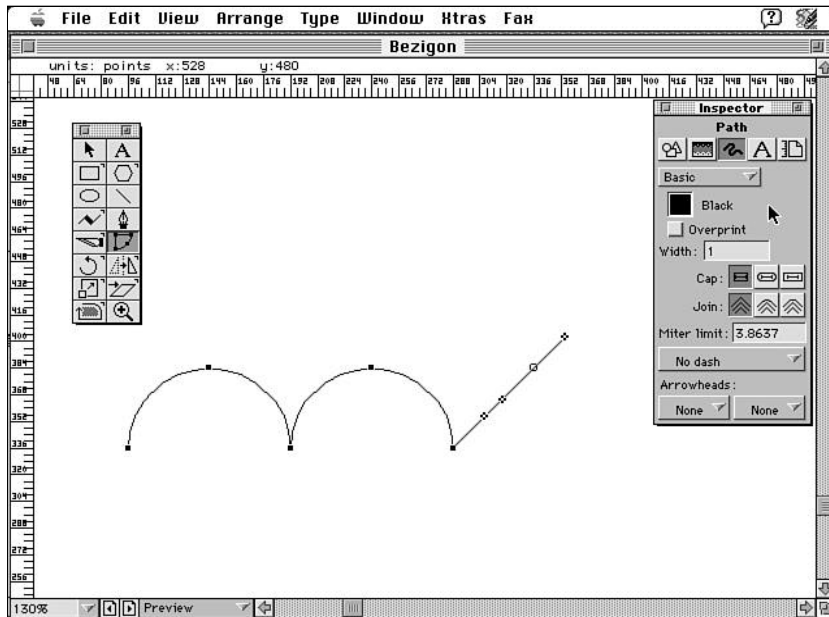

Figure 16.19

The last curve in this series of three does not appear even though the curve point has been set. The curve will appear when the corner point at the end of the path segment is placed.

After you learn to control the many palettes, they seem quite handy, but the Inspector palette is one that is particularly key to the operation of FreeHand. This palette has several modes depending on the desired operation. Icons at the top of the palette represent five major control modes: object, fill, stroke, text, and document. Additional icons, check boxes, buttons, fields, and pop-up menus within each mode provide specific control over all operations. See Figure 16.20 for an example of the Inspector in object mode. The document mode is also interesting because it shows FreeHand's neat way of creating and arranging multiple pages (see Figure 16.21). Multiple pages can be arranged in the large (222×222-inch) Pasteboard area by working with thumbnail pages. Icons control the display size of thumbnails. The default page appears in the middle of the pasteboard, but a page can be moved by dragging its thumbnail image (see Figure 16.21).

Three page thumbnails have been arranged side-by-side in the Document Inspector (upper right). The result is three separate 8.5 × 11-inch illustration pages on the 222 × 222-inch Pasteboard. If necessary, the pages could all be different sizes.

**Figure 16.20**

The Object Inspector provides control over paths, anchor points, control handles, and so on.

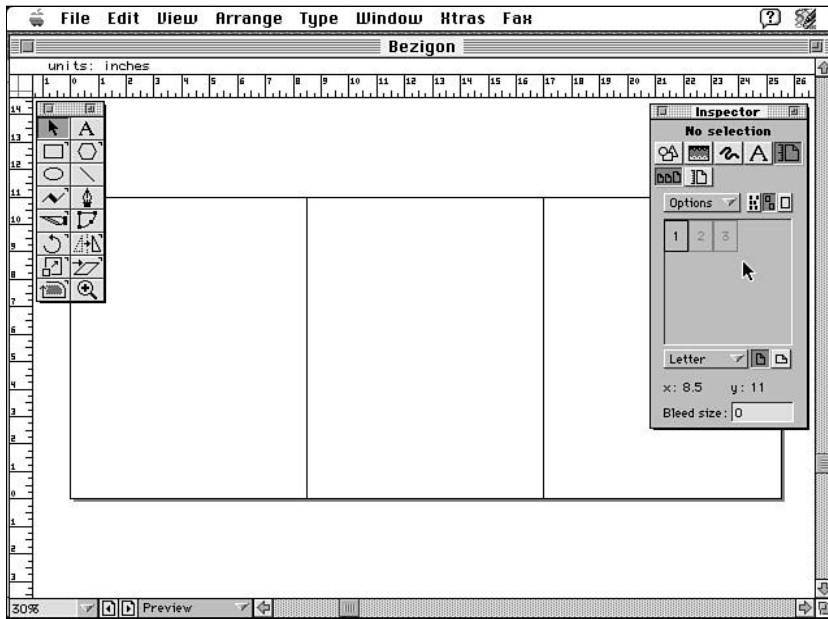
**Figure 16.21**

Three page thumbnails have been arranged side-by-side in the Document Inspector (upper right). The result is three separate 8.5×11-inch illustrations on the 222×222-inch Pasteboard. If necessary, the pages could all be different sizes.

Drag-and-Drop Color and Other Goodies

I like the way you can drag around color swatches in FreeHand. Two separate palettes are provided for color control: the Color Mixer and the Color List, and colors can be dragged back and forth between the two. A process color mix (CMYK), for example, created in the Color Mixer can be dragged into the Color List, and it is automatically added to the list of colors. Pantone and other color matching systems can be accessed from

the Color List palette, and these colors can be dragged around, too. Color swatches can also be dragged into the Inspector or into lines and shapes on the illustration page. It's fun!

Like Adobe Illustrator, Macromedia FreeHand provides fairly robust typographic features, including text on a path and other special effects. FreeHand has an awesome way of linking text blocks. You just drag a Link line from the Link box of a text block to any other text block or open or closed path. FreeHand's text blocks are much more dynamic than Illustrator's. Text blocks can be expanded or contracted, and kerning, tracking, word spacing, and leading can be adjusted on-the-fly by dragging handles in combination with various keys. Implementing FreeHand's text on a path function is not as elegant as its rival's—requiring the use of a menu command—but when it's done, it works about the same.

Great Alternatives: Deneba Canvas and CoreDRAW!

I was being only a little facetious earlier in this chapter when I described the selection of a “one and only” drawing program by an imaginary alien from outer space. I really do believe that Deneba Canvas is an impressive illustration software package. Canvas's features include vector drawing tools as well as bitmap tools. Canvas comes with about 2,000 fonts (both PostScript Type 1 and TrueType) and something like 20,000 clip art images on CD-ROM. The Canvas user interface and tools will not be strange to users of Illustrator or FreeHand with the possible exception of the painting tools. Anyone, however, who has used a painting program, such as SuperPaint, should have no problem with them. Canvas has always been marketed more as a technical or engineering drawing application, but Deneba has recently made more effort to make it more attractive to artists and illustrators. This program can pretty much do anything that Illustrator and FreeHand can do, although it's not anywhere near as popular.

NOTE

Some newer drawing software applications for the Macintosh take a more painterly approach than Illustrator or FreeHand. One called SmartSketch from FutureWave Software has been getting good reviews. SmartSketch encourages a looser, more spontaneous approach to drawing. It has intuitive tools and makes vector-image drawing seem almost as easy as painting. With SmartSketch, shapes can be sketched, altered, and colored in the direct way that one experiences with painting software programs. SmartSketch cannot compete with the big boys, but with a street price of around \$50, it's a must-have.

A similar program called LightningDraw GX from Lari Software has not done as well with the reviewers as SmartSketch, but it's worth considering. This program requires the QuickDraw GX 1.1 extension of System 7.5 (a memory hog) and costs a lot more than SmartSketch, but it has some impressive capabilities. LightningDraw GX also has a less structured approach to drawing and editing paths. You can reshape paths by dragging them at any point and can adjust the sensitivity of these actions. LightningDraw also does some interesting things with color blending and special typographic effects.

Modeling: The Illusion of Roundness

Flatness is a major attribute of vector graphics. All drawing programs have the same *modus operandi*—they let you draw outlines and fill them with colors or patterns. They produce, for the most part, rather mechanical-looking images with hard edges. There is nothing wrong with this, and there are plenty of uses for this type of image, but most artists and illustrators like the illusion of roundness, or modeling. Modeling is the process of creating a three-dimensional look by shading and highlighting. Traditional artists take it for granted, and that's why many of them don't like vector drawing programs. Of course, the 3D look is fairly easy to achieve if the object is a cube. Linear perspective and shading on the cube's sides usually make a convincing 3D object (see Figure 16.22). This kind of effect is simple to produce with Adobe Dimensions. Spheres, cones, and cylinders are also easy to render as 3D objects in Dimensions, and one of the first things to attract me to CorelDRAW! was its capability to extrude, rotate, and light geometric shapes. Irregular rounded shapes, however, are a little more difficult. For example, how do you make a drawing of a banana look three dimensional?

There are two ways one can approach this modeling effect in a drawing program. One is by the use of gradient fills and the other is through blending. The roundness effect with gradients works best with cylindrical or spherical objects (see Figure 16.23). Being able to change the light source (highlight) is an important function in the use of gradient fills, and Adobe Illustrator excels at this with its Gradient tool. CorelDRAW! is also very good at it. But what about the banana? Gradient fills just don't quite make a convincing banana. For this you must use the blend feature where one shape is blended into another through a series of steps. In the blending function, drawing software extrapolates and automatically draws a series of shapes as logical intermediate steps between two shapes the user has selected. I do not guarantee this process to be perfect, mind you, but it can be made to work with a little trial and error. The secret to better blends is that the two original shapes should have the same number of anchor points located in the same relative positions. The more steps there are in the blend, the smoother the shading effect will be.

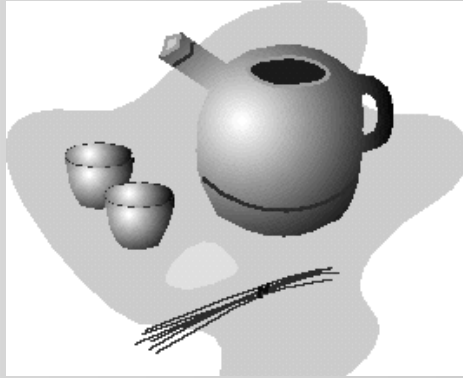

Figure 16.22

The illusion of roundness makes a subject appear more realistic. Here, radial gradients are used to give the modeling effect.



Figure 16.23

On the left, a basic banana shape is drawn and filled with black. The shape is duplicated and stretched to form a high-light shape filled with a 15% tint. Blends work best if the two shapes have the same number of anchor points located in the same relative positions. After the blend is performed (right), intermediate shapes form a modeled effect.

CorelDRAW! has been a blockbuster on the PC/Windows platform for years. At the time of this writing, it was scheduled to be released for the Power Macintosh in mid-summer of 1996. CorelDRAW! will be part of a package containing a photo-editing program similar to Photoshop, a tracing program a la Adobe Streamline, a multimedia file manager, a font manager, a 3D modeling program, an image texturizing program, 25,000 vector clip art images, 1,000 fonts, 1,000 photo images, and 750 3D models. Whew! No wonder this baby is so popular with Windows users! The Mac version of CorelDRAW! is supposed to be fully PostScript capable as well as supporting QuickDraw GX. I have used the Windows version for years and have always liked it, thinking it more powerful and versatile in many ways than either Adobe Illustrator or Macromedia FreeHand on the Mac. One caveat, however—the first releases of the last several Windows versions all had many bugs that had to be fixed with updates. It's always wise to beware the first release of any software, but be particularly wary of this one. Lay low and check out the reviews in the trade magazines before you buy anything that doesn't have a track record.

DrawTools' Plug-Ins Add More Functionality

DrawTools from Extensis is an award-winning set of plug-ins for Adobe Illustrator and Macromedia FreeHand. DrawTools provides filters for object positioning, color management, and object-projection 3D effects. With DrawTools you can do things like wrap vector images around 3D objects, create duo-tones and tri-tones, and position objects according to precise coordinates. DrawTools is reliable and has consistently received good reviews.

NOTE

User-definable layers are distinctly separate drawing layers analogous to the transparent overlays of traditional paste-ups and mechanical drawings. All graphics software applications use a stacking order to arrange objects, and this is controlled with “bring to front” and “send to back” commands. User-definable layers go beyond this to provide separate layers that can be selectively locked and/or hidden. User-definable layers are a key feature in leading illustration software applications such as Adobe Illustrator and Macromedia FreeHand. In complicated drawings, user-definable layers are very useful for making elements easier to select and speeding up screen redraw.

The point is, design is design. The computer is just a tool. It shouldn't guide your design, or inhibit it in any way. If it does, you have the wrong program. Inspiration and imagination are gifts we have. Technology is the tool through which we share these gifts.

Beth Rose
Lesman Instrument Company,
Elmhurst, IL
Marketing Print and
Interactive Design

18

3D and Animation

Everybody wants to do it. It's like a virus that's spreading through the design community. Clients are asking—Can you make it look 3D? Your answer—Sure! Then you come back to your computer and attempt to dive into 3D head first. The first challenge is which program to use. The next is trying to figure out what all of the new windows and tools are in front of you. Depending on which program you choose, it may be a major nightmare or just a small flashback to the first day you started using the computer.

If you want to know... Go to...

What are the minimum hardware requirements?	402
Are there any inexpensive alternatives?	404
What are the advantages of Infini-D?	405
What are the advantages of form•Z?	417
What are the advantages of ElectricImage?	428
What are Boolean functions?	410
What is Inverse Kinematics?	432

Remember, just because it's 3D doesn't necessarily make it better. Just like any other tool, 3D programs are exactly that—tools. Your job as a creative professional is to communicate your client's message as clearly as possible and within budget.

A word of caution: 3D is not as instantly gratifying as 2D work. You can spend a very long time creating a 3D scene, render it for a day or two and then see something wrong with the final rendering.

The Software

As a beginning 3D user, don't bury yourself in quicksand right away. Take it slow and make it easy on yourself and your bank account. Don't go for the high-end, bells and whistles program if you don't need it. It will cost you dearly in time and money. For less than \$1,000, you have a wide variety of 3D programs to choose from. Two of the most stable and most versatile beginning 3D programs are:

- Specular Infini-D. Among its features are: a spline-based modeler to create custom objects, Boolean functions, extensive lighting controls (including lens flares), the capability to combine many surfaces on one object, velocity controls to add more realism to your animation, and Animation Assistants that help you automatically create movement. This package can be picked up for about \$450 mail order.
- Specular LogoMotion is a basic 3D program best used for logos, titles, and simple 3D graphics. It has lots of built-in features: cool lighting effects, graphic elements, and so on. You can pick this up for about \$130 mail order.

The interfaces on both of these products have been thought out carefully, and it shows. Menu items are logically ordered and the tools are easily understood. Now you're saying—sure, easy for you to say. We'll take a look at some easy-to-use, but powerful features a bit later.

Getting into more complicated 3D requires a bit more money and different programs. The next serious step up is form•Z and ElectricImage.

- form•Z** is a feature-rich modeling and rendering program geared for accuracy and complex modeling. The renderer is powerful, but lacks a few features that are made up for in ElectricImage. You can pick up the modeler for \$1,495 or RenderZone (modeling and rendering) for \$1,995. form•Z is compatible with Infini-D, so if you want to take it slow into more advanced modeling, get Infini-D to learn with and then get form•Z to create more elaborate models and import them into Infini-D for rendering and animating. Then, when you can justify it, get ElectricImage (the next item on the list).

- **ElectricImage** is an animation and rendering package. It is the most powerful renderer on the Mac platform without a doubt. No other 3D software even comes close to its rendering speed. Version 2.7 (should be out by the time you read this) will come in 3 flavors: film version for \$7,495, broadcast version for \$2,995, and the scholastic version for \$795.

The end of the chapter contains a rundown of features for all of these products.

Other Support Software

The deeper you get into computer art and desktop publishing, the more you realize that no program is an island. It is especially true with 3D. You will also need several other programs to get the most out of your 3D experience.

The “Gotta Have It” List

- **Adobe Photoshop.** The standard for pixel-based design. This program will help you create textures and images that you can later import into your 3D program and “attach” to objects. After creating a 3D scene, you can open the rendered file in Photoshop and add other effects or combine it with other images. (Fractal Painter can also be used.)
- **Adobe Illustrator.** The standard for object-oriented design. This program will aid in creating accurate objects and logos. Additionally, the path filters can be most useful. After the 3D file is complete, you can import the rendered file into Illustrator and add PostScript text (makes it very smooth) or other art to it. (Macromedia FreeHand can also be used, but you need to export the art or save it in Illustrator format in order to use it in Infini-D or Photoshop. Personally, I don’t like to make more work for myself.)

The “Nice To Have” List

*Warning, these will end up on your “Gotta Have It” list eventually.

- **Specular TextureScape** is a texture generation program that works by layering and combining objects and applying lighting effects. I am constantly amazed at what you can do with a few simple objects in this program. You can make all kinds of cool surfaces to use as repeating patterns in 2D or 3D work. Additionally, you can create morphing textures as QuickTime movies. This program ships on a CD that has 600 (most of them useful) textures ready to go for use in your 3D scenes.

- Adobe Premiere** is a video editing program that enables you to add other effects to your 3D project. You can render the completed frames to another computer file or lay it to tape, depending on your set-up.
- Adobe After Effects.** A special effects, 2D animation, and video editing program with many features that enhance and complement those in ElectricImage and Infini-D. An exceptional timeline interface affords fine-tuning of motion control over layered elements, and it is the only program on the market (besides ElectricImage) that accepts ElectricImage format directly. It is the next step beyond Premiere and a must for those interested in making 3D and video part of their lives.
- Macromedia Director.** A multimedia authoring program that allows you to create interactive projects for use on CD-ROM and the World Wide Web. You can use your 3D graphics in Director as animations, still images, as buttons, and so on.
- Equilibrium DeBabelizer** enables you to process images in a number of ways for transfer to other platforms and programs. (This program is so cool! The last book I wrote had over 500 screen captures and I had to translate all of them to grayscale images. What would have taken me about 2 days manually, took DeBabelizer less than an hour!)
- Specular BackBurner.** A network rendering program. You set up the main program on one machine and “agents” on the other machines. The main machine then divides the work among all of the machines, with each machine doing part of the work. The result—decreased rendering times. You can also batch render, meaning that you can set up several renderings at once and walk away until they are done without having to reset the machines. Also, rendering can be suspended and resumed at a later time. And, one last great thing—if the power goes out, you don’t lose everything rendered up until then—it’s crash proof!

Minimum Hardware Configurations

These hardware configurations are the minimum for the serious 3D designer using Infini-D or form•Z. It doesn’t mean you cannot use anything less, but realize that rendering your 3D files (especially animation) can take hours, days, sometimes weeks, so the more power, the better.

- Power Mac 7100
 - If using less than a Power Mac, you must have a math co-processor.
- 48MB of real RAM (not with virtual memory, RAM Doubler or similar utility)

Note: ElectricImage recommends an 80MB RAM configuration, and 40 is the absolute minimum. LogoMotion can work quite effectively on a machine with 16MB.

- 16" or larger monitor (2 side-by-side is better yet—one for floating palettes)
- Internal hard drive (500MB or better) for your applications, fonts, etc.
- External hard drive (1 gigabyte or larger) for your files
- Back-up media (optical drive or CD Recordable)
- CD reader (lots of this 3D stuff comes on the CD)
- Modem (28.8 or better)

Infini-D Production Studio™

Specular has recently announced the Infini-D Production Studio. This combination package includes: Infini-D, BackBurner, the Pro Resource CD (lots 'o scene files, utilities, models, textures), the Replicas CD (more textures, models, surfaces, and so on). Preliminary pricing information indicates that you will be able to purchase this bundle for as little as \$600.

So, What is 3D?

3D can be different things to different people, but here are the general workings:

- 1 You create the models (objects). This is called modeling.
- 2 You apply surfaces to the models. This is called rendering. This really happens in two steps: 1) creating and applying the surfaces to objects and 2) exporting (rendering) the final image.
- 3 You move the objects in space. This is called animating.

You can create a single frame that will end up as a static image or you can create multiple frames that will end up as an animation. This is analogous to a Photoshop file with layers vs. a TIFF file used in a page layout program. The Photoshop file with layer information is like the 3D working file and the TIFF file (no layers—not changeable for the most part) is like the final file rendered from the 3D program.

The most obvious difference between working in 2D versus 3D is that you have to deal with objects in three dimensions. This can be very awkward, especially at first, but if you take it slow and really try to understand what you are doing in a simple way, you will master it soon enough.

3D Space

To begin understanding 3D space, try placing nothing more than a simple cube in Infini-D. Use each of the move, rotation, and scale tools in each of the views to understand how they work. Look at the other view windows as you use the tools. Each time you release the mouse, be sure to Undo the last move so that you are always starting from the same point.

LogoMotion

LogoMotion is a modest 3D program that enables you to model (on a limited scale), render, and animate. Although it has limitations, it is the ideal 3D program to use for flying logos and simple animation. You can import and export several different formats and create basic surfaces within the program. There are built-in camera moves, animated objects (circling stars, whizzing comets, flashing dollar signs, and so on), and preset lighting effects. It is very easy to use even for the beginning Mac user.

Interface

The interface is extremely simple with buttons and button subsets that give you access to just about every feature (see Figure 18.1). Preset lights, camera moves, animated objects, surfaces, backdrops, bevels, and more are just a click or two away. Even if you only use the program for a few projects, it is well worth the price for its ease-of-use and as a basic introduction to 3D.

Toolbox



Preset animated objects for quick effects

Sequencer to control animations

Camera View Window

Figure 18.1
LogoMotion Interface

Infini-D

Infini-D is also an easy-to-learn 3D program with some very powerful features. It does what LogoMotion does (without all the built-in gimmicks). Additionally, it has an excellent modeler, has some of the strongest surface composition features available in any Mac program, and animating is easy and intuitive. Infini-D imports and exports many different file formats for a variety of uses.

Interface

Infini-D's interface consists of two primary working areas: the World and the Workshop. The interface in both areas are such that you can see as much or as little information as you want. There are many windows, window layouts and floating palettes that can be opened and closed easily—most with a shortcut key combination or a mouse click.

The World

The World (see Figure 18.2) is where you create your models, apply surfaces to objects, adjust lighting and animation, navigate, and view your work. In addition to interactively changing objects with the mouse, there are palettes that allow detailed control over various parameters. Many of these palettes also have additional dialog boxes that can be accessed. (It is really beyond the scope of this chapter to show you all of the options, but you will get the general idea.)



Figure 18.2
The World with Toolbox

The Toolbox (Figure 18.2) to the left of the view windows allows you to create objects (which can later be edited), rotate and scale objects, hierarchically link objects, add cameras and lights and navigate with standard navigation tools in the view windows. (The shortcuts for the hand tool and the zoom tool are the same as in Photoshop, Illustrator and FreeHand.)

The Object Floater (see figure 18.3) enables you to select, rename, position, rotate and scale objects to fractions of a measurement. Additionally, you can make objects invisible, turn their shadows off/on and constrain their movement.

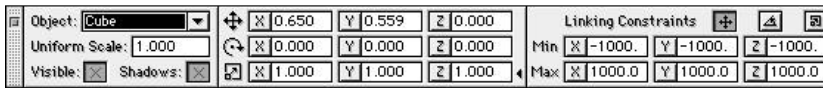

Figure 18.3
Object Floater

The Navigation Floater (see figure 18.4) enables you to navigate left/right, up/down and in/out of views. And, in camera views, it allows you to pan, tilt and rotate the camera.

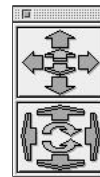

Figure 18.4
Navigation Floater

The Light Floater (see Figure 18.5) gives you control of three of the four different lights in Infini-D. You can change the color and intensity; fall-off, width and softness of spot light cones; apply gels and masks to spot lights; rotate distant lights; adjust fall-off of point lights; turn shadows on and off; and the Light Info button brings up a more detailed dialog box for those who want to be really accurate.

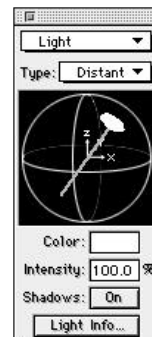

Figure 18.5
Light Floater

And, last, but not least, new to this version of Infini-D is the lens flare option (called SuperFlares™). Activating this gives access to the Lens Flare dialog box (see Figure 18.6), where you can adjust the glow, halo, streak, reflection, and so on of the light. Additionally, you can animate the SuperFlares over time.

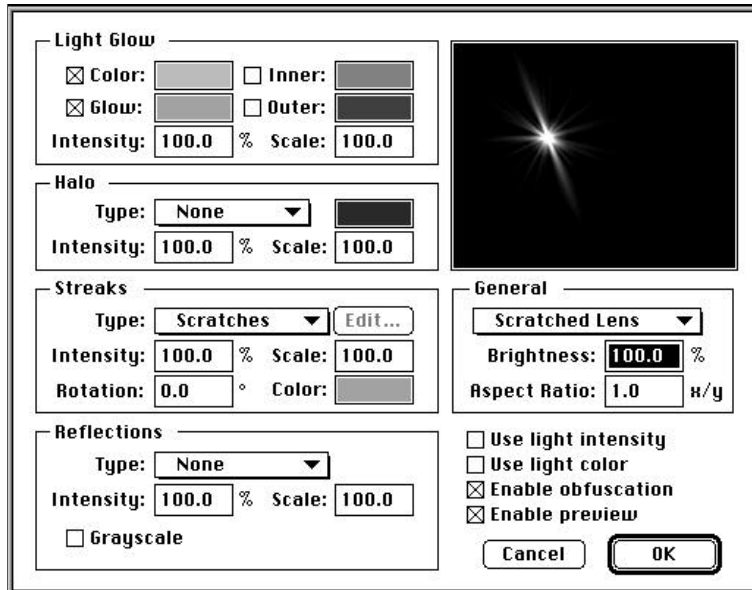

Figure 18.6
Lens Flare dialog box.

The Views Floater (see Figure 18.7) has several options that change the way in which you view each of the windows in the world. Different shading and anti-alias levels allow you to see more or less detail in each view window. Bookmarks allow you to save the position of the camera and your point of view for later use.



Figure 18.7
Views Floater

The Surface Floater (see Figure 18.8) makes it fast and easy to create, apply, delete, and edit surface information.



Figure 18.8
Surface Floater

The Sequencer (see Figure 18.9) is where you animate objects and models, adjust their individual parameters, link and unlink hierarchies, and preview animations—all down to the individual frame. Because Infini-D's Sequencer is time-based, you easily can lengthen and shorten animations or parts of animations very intuitively (yes, even for the beginner).

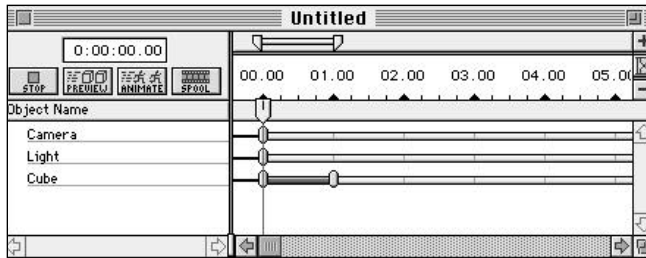

Figure 18.9
Sequencer

Three key features of Infini-D which make it a powerful, professional-level program are: velocity controls, spline-based motion paths and surface composition. Let's take a quick look:

Velocity Controls

When animating, the velocity of each object's position, center point, rotation, scale, and uniform scale can be adjusted. The Velocity dialog box's graph (see Figure 18.10) corresponds directly to the Sequencer, and each eventmark can be adjusted up and down to increase or decrease the velocity. Additionally, each eventmark's velocity can be eased in and out by adjusting the handles and even split to correspond to sharp movement (like a ball hitting the floor).

Each object that moves in Infini-D has a path of motion that can be activated and viewed from the Animation menu. When visible, you can adjust the path of the object by simply pressing and dragging a point on the path in the view window (see Figure 18.11).

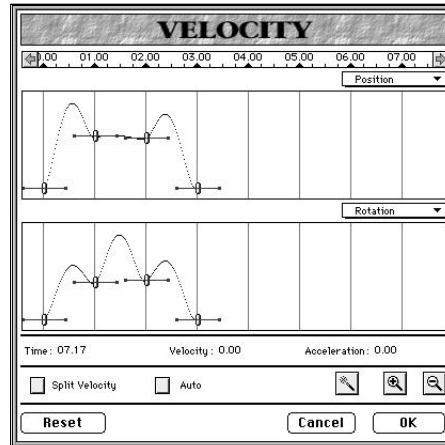

Figure 18.10
Velocity dialog box

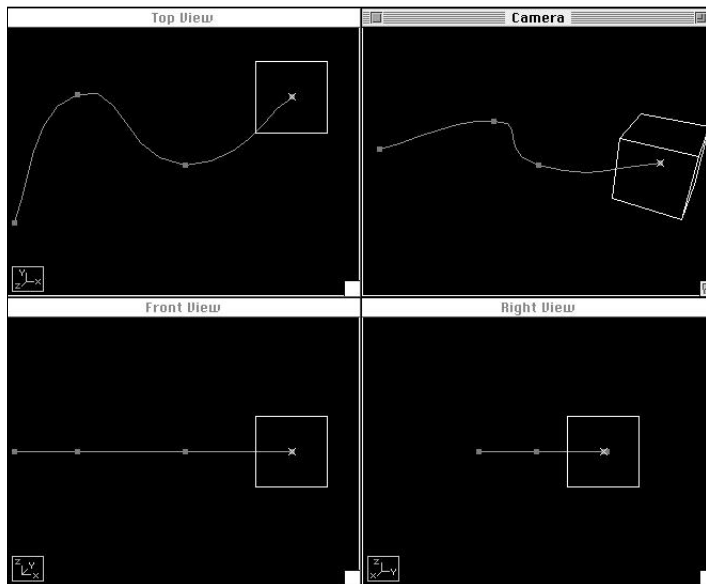

Figure 18.11
Spline-based Motion Paths

Surface Composition

Infini-D sports one of the most powerful surface composition capabilities of any Mac 3D program (including form•Z and ElectricImage). You can use procedural surfaces created within Infini-D, image and texture maps, and QuickTime movies all combined and layered in one surface, and then apply it to your object all at once. This means that you have more control over each object's surface elements. Especially notable are the decal mode and bump maps. Decal mode enables images to be “fused” to objects, such as waving flags, curtains, and so on. This keeps the surface from “slipping” as the object animates. Bump maps change the texture of a surface to make it appear raised or depressed and more realistic. A good example is the slightly raised logos found on a soda bottle that look like embossed glass. Also, see the Zima bottles in Figure 18.22.

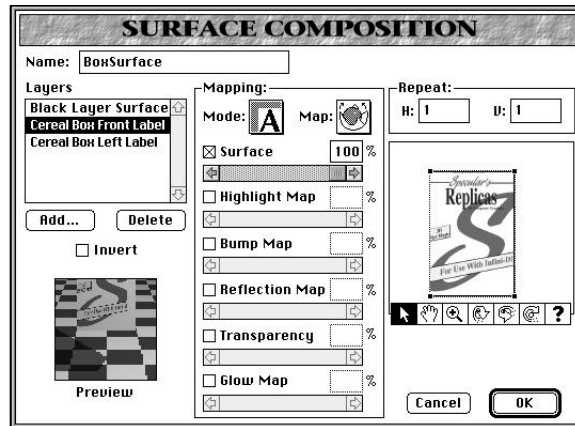

Figure 18.12
Surface Composition dialog box

Boolean Functions (Operators)

New to Infini-D 3.5 are Boolean functions. These enable you to use objects to “carve” shapes out of other objects. In Figure 18.13 there are several complex objects that were created from simple objects. The trick is that some of the objects were defined to be negative. The slit, for example, in the top of the screw is created with a negative rectangle, and the die used negative spheres to cut into the cube. The object on the left has a cylinder cutting into the top edge and a cone piercing the side. There are many uses for Boolean functions. Combining positive and negative shapes opens a whole new world of modeling options. And, of course, these Booleans are animatable!

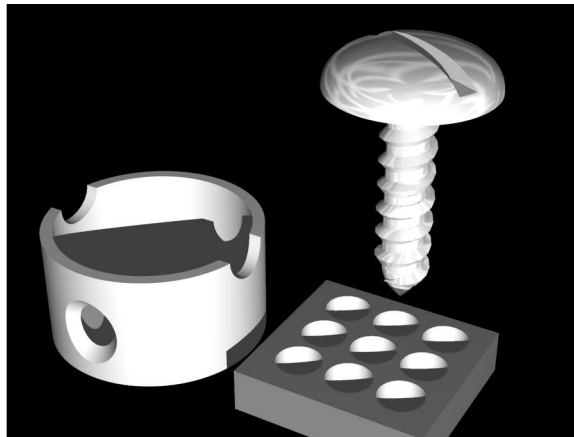

Figure 18.13
Boolean functions create more complex models.

ShadowCatcher™

Also new to this version of Infini-D are ShadowCatcher. This is a cute term for a very important feature if you are compositing your animation to video. Infini-D will render the shadows cast from the objects as well as the objects so you do not have to fake the shadow over the video later—a very powerful, professional-level feature.

Infini-D's Workshop

The Workshop is where you create custom objects. Depending on the object you start with in the world, Infini-D will present you with a different set of windows in the Workshop (see Figures 18.14 and 18.15). Don't let that throw you. Objects in the Workshop are really all the same (called SplineForms™). It's just that very often, you do not need all of the views to create what you want. Never fear, however—all views of the object are available in the Windows menu.

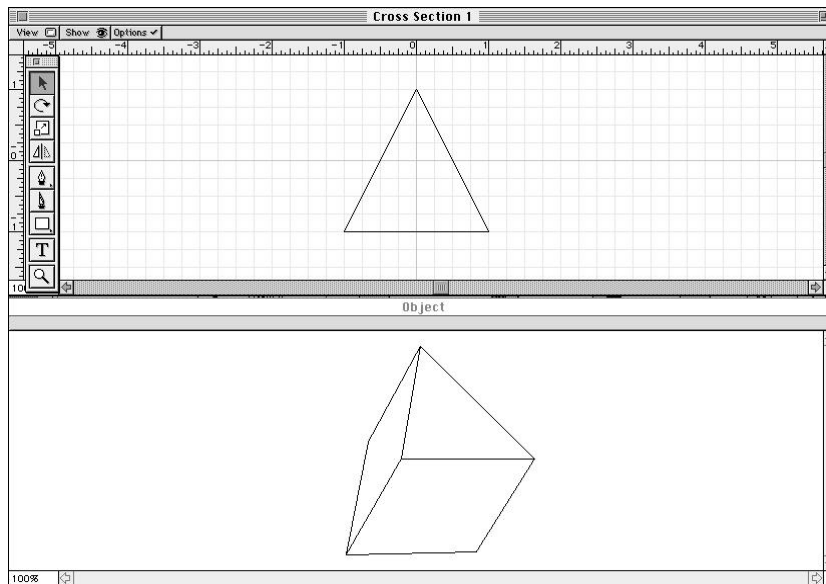

Figure 18.14
The Workshop with a simple extrusion.

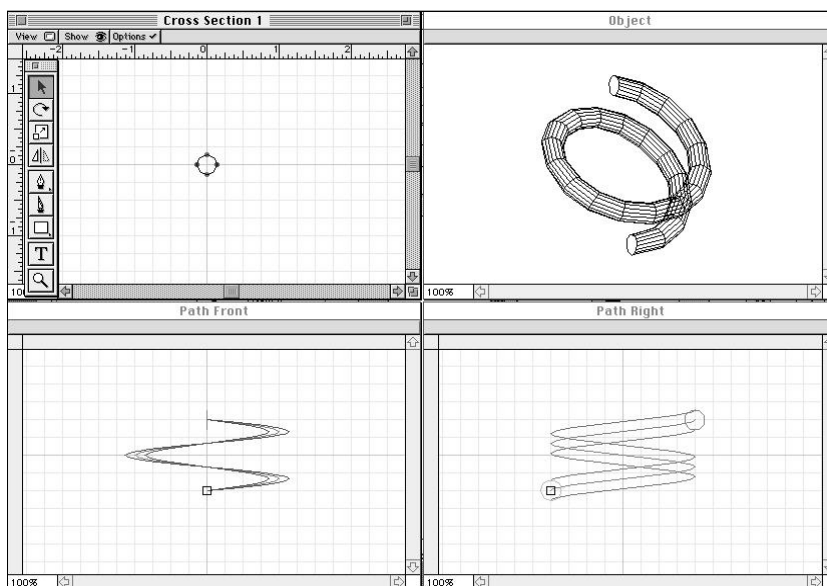

Figure 18.15
The Workshop with more complex objects.

Infini-D's Workshop is based on the concept of cross sections (2D shapes), paths, and rails. If you have a cross section—say a circle (Figure 18.16), it can be pulled along a straight path to create a cylinder (Figure 18.17), and its rails can be altered to change the outer surface of the object, which makes it look like a wine glass (Figure 18.18). To go a step further, you can also bend the path that the cylinder is following (Figure 18.19).

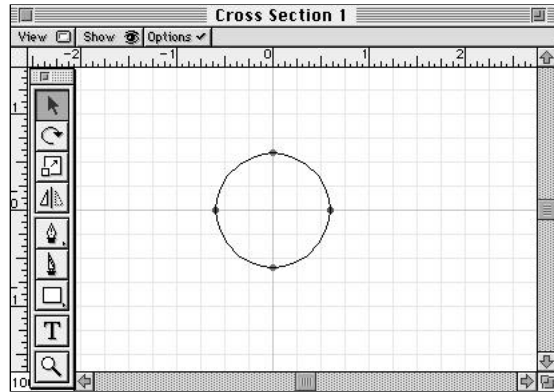

Figure 18.16
Cross section

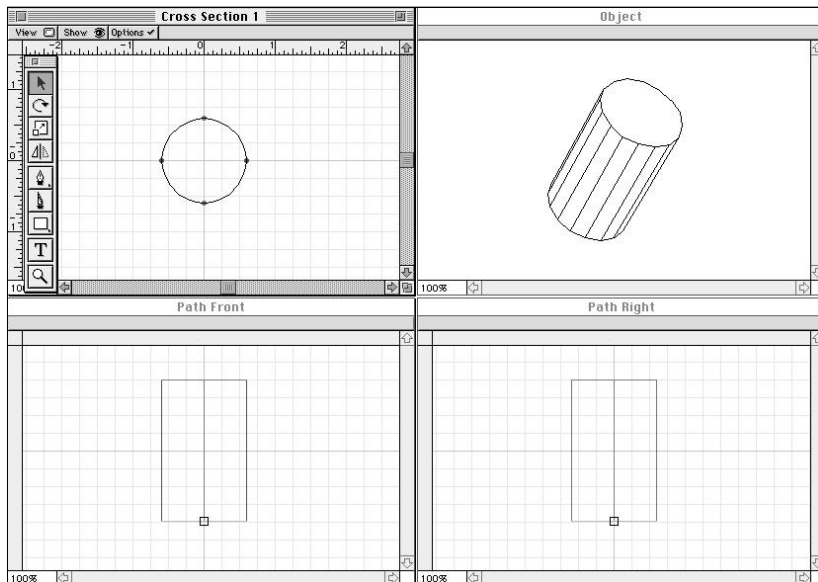

Figure 18.17
Cross section pulled along a path.

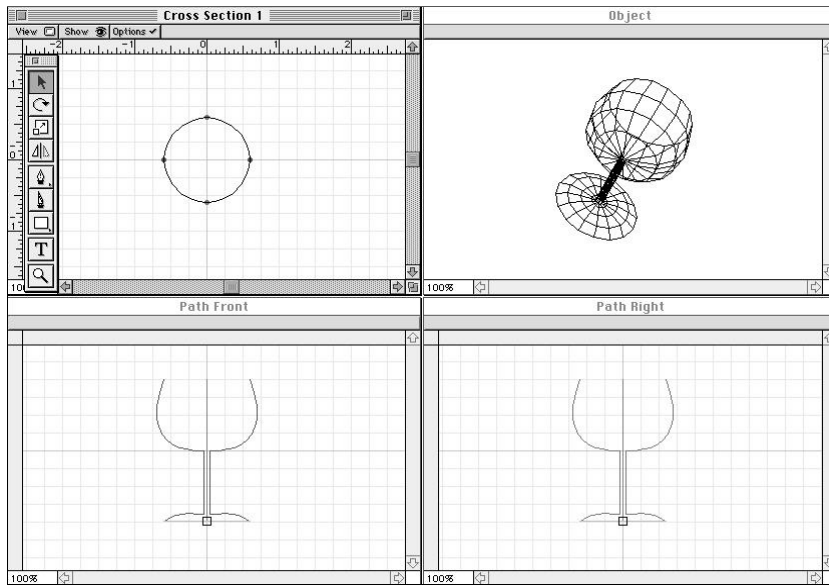

Figure 18.18
Rails manipulated to create a wine glass.

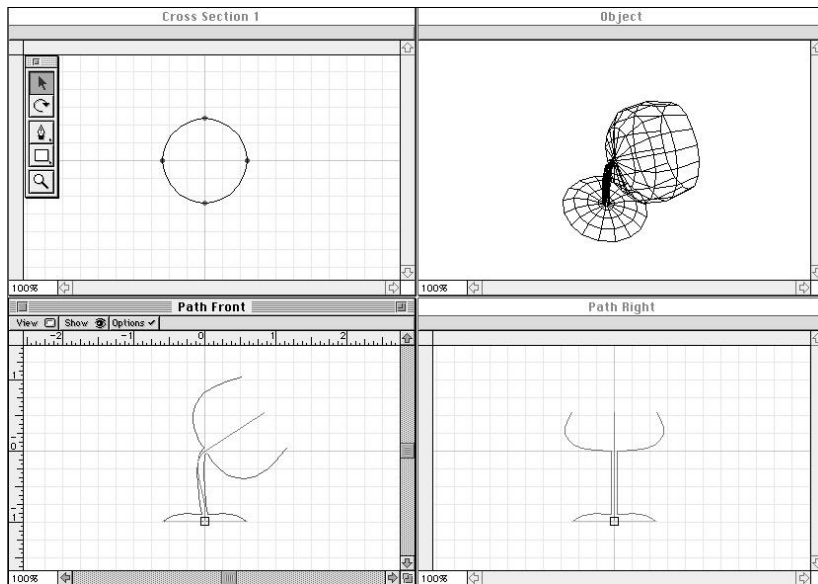

Figure 18.19
Path of wine glass bent.

Using Infini-D

Depository Trust Company

Depository Trust Company needed an animation for the introduction of a training program that was to be delivered on CD-ROM, CD-i, and video (see Figure 18.20). The frames were created and rendered in Infini-D at 640×480 pixels to individual PICT files. They were then rendered to appropriate files as needed for each media from a Media 100 (high-end video editor). The total animation was eight seconds long.



Figure 18.20
 Depository Trust
 Company's
 Introductory Logo
 Animation ©1995
 Michelle Szabo
 New Media Designs

Dream World Productions

The Dream World Productions logo, created in Infini-D (see Figure 18.21), identified the production company immediately before the show was broadcast. The Dream World logo was already created in Adobe Illustrator, so it could easily be imported into Infini-D as an extruded object. Then the animation was created in reverse order to avoid re-creating the logo again at the end. Infini-D has an Animation Assistant called Reverse that makes

it easy to create animation sequences backward and then automatically reverse the sequence. It is often easier to work like this. Environmental mapping gave it a slight reflective quality while keeping the rendering time within reason. The animation was rendered to individual PICT files at 640×480 pixels and laid to tape on a Macintosh 8100/80 with a Media 100 setup. Then the video was set to music in an online analog editor for broadcast.

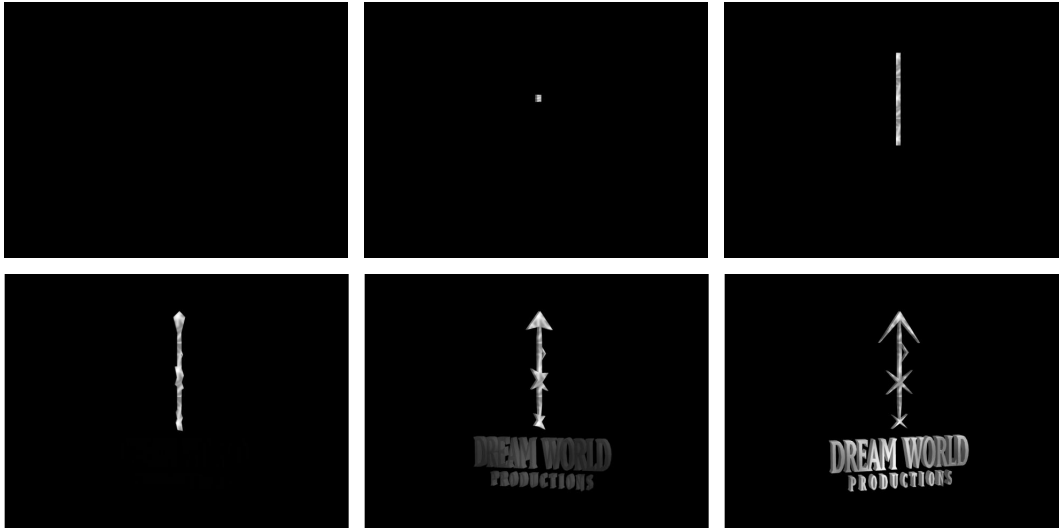

Figure 18.21
*Dream World
 Production's
 Introductory
 Logo Animation*
 ©1995 Michelle
 Szabo
 New MediaDesigns

Packaging and Product Design

3D programs can be especially useful with visualization in this area of design. It is much easier for a client to understand what their new packaging or product will look like when you show it to them in 3D. Anything from a simple 6-sided box package design to more complicated packages and product design can be created in 3D programs.

Zima

The image in Figure 18.22 shows how to use a composed surface effectively. Several layers of mapping are used on the bottles: a glass surface was assigned for transparency, a surface map for the label, and a bump map was used to make the ridges on the bottles, to save modeling and rendering time. Fog was used to create the bar atmosphere.

Monster Truck

The monster truck in Figure 18.23 uses many custom objects created in Infini-D's workshop. Bump maps were used to create the treads on the tires and SuperFlares on the three lights added realism to the scene.

**Figure 18.22***The Zima Bar*

©1996 Dayan Paul-Digital
Nightmare Productions

**Figure 18.23***Monster Truck with SuperFlares*

by Lincoln Lydick, ©1996
Specular International

There are certainly many other applications for Infini-D, and Specular promises major changes in future releases of the program in the areas of modeling, rendering, and animating, so it can only get better... stay tuned.

3D On The Mac—High End

As you now know, working in 3D applications typically involves several different processes: modeling, animating, and rendering. Some programs do all three functions, and some have only one or two. Although the benefit of working in an all-in-one program cannot be overlooked, there also must

be the consideration of picking the best tool for the job, and in some cases, it makes more sense to choose different programs for different functions and export from one to the other to get the job done.

In Mac 3D animation, there are a number of programs that are considered entry-level, but only a few that can be called high-end. Among these, form•Z and ElectricImage are the best in their class—form•Z as a modeler and ElectricImage as an animator/renderer. It's fortunate that these programs work very well together, and have become a standard combination for professionals producing large, complex, deadline-oriented 3D work for broadcast and multimedia. Additionally, form•Z exports models that can be used within Infini-D, so you are not throwing your money out the window when you begin by using Infinidi and later add form•z to your repertoire.

form•Z

form•Z was conceived as a program designed for architects, whose projects required great precision, if for no other reason than to keep their creations from falling over on people (a concern not usually shared by graphical designers and artists). Until a few years ago, 3D software fell into one of two categories: one group of programs, oriented toward design, had features such as spline-based modeling and beautiful rendering effects but very little control over the accuracy of modeling. The opposing camp was made up of programs that were extremely accurate with powerful modeling features, but had a very steep learning curve and were accessible only by engineers or architects.

Why form•Z?

form•Z's strengths are its weakness: It has so many options and so much flexibility, it can be overwhelming, and this causes it to have a steep learning curve. It does have its own way of thinking, which takes time to become accustomed to, but after you learn it—like a language—it all makes sense, and the logic of the program is very consistent. There are also more than 100 tools and tool modifiers, and it takes time just to become familiar with them all. There are many tools that are unique to form•Z, and many that are present in other modeling programs but are implemented differently or better here. As you read through the rest of this chapter, you will see the importance of form•Z's modeler from many different aspects.

Interface

form•Z's interface might look familiar to users of 3D software when they first open the program. The main graphics window opens with an axonometric view of the XY grid, or ground plane.

Along the lower edge of the graphics window is the planes palette, which switches one of the three default reference planes: the XY, YZ, and ZX, representing top, right, and front views. To the right of this palette are the window navigation tools. These are used for zooming, panning, and rotating the view. The snaps palette constrains tools to specific angles and also snaps the tools to parts of objects: snap to point, face, segment, midpoint or endpoint of segment. There is a grid snap that makes tools snap to the grid of squares on the reference planes. All parameters are customizable: the default grid can be changed from feet to inches or meters, and numeric accuracy is definable. Custom presets can be created and loaded, enabling different users to customize their own work environment.

The tool palette contains the tools and their modifiers. This palette is broken up into a number of pull-out subpalettes, organized according to tool and modifier types. The modifiers are followed by the tools that they directly modify.

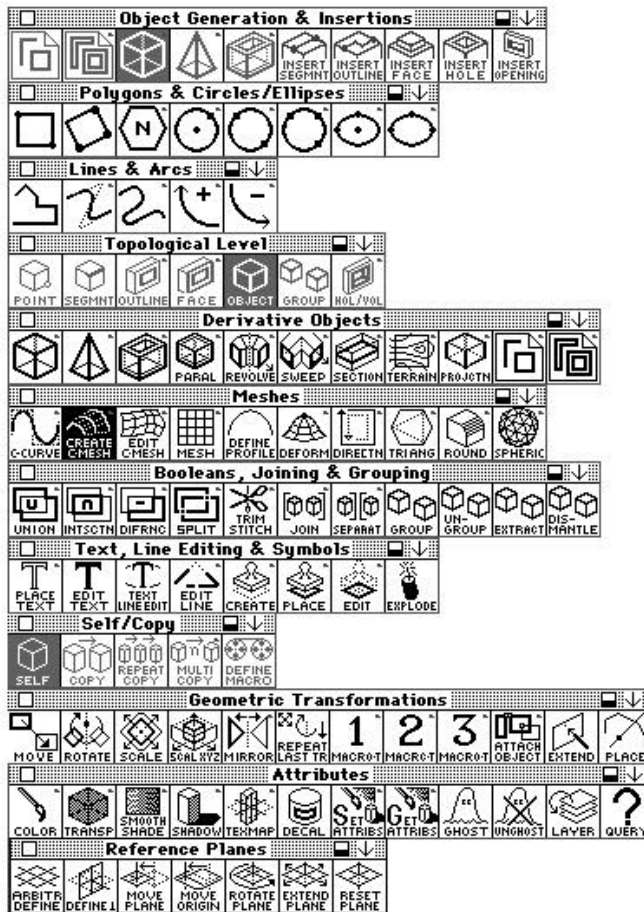

Figure 18.24
form•Z's tools

Each tool is also user-definable, and tool options are accessed by double-clicking or Option-clicking on the tool icon. Double-clicking a circle or arc tool brings up the options for how many segments will define the

curve of the arc. Options for line drawing tools include curvature parameters that can be typed into a text field in the Options dialog. Modifier options include such features as wall width on the enclosure modifiers, and whether the tool will create a structure that is open or closed at the ends.

Following the drawing tools are the Topological Level Modifiers. These control how the tools act upon an object. They are: Point, Segment, Outline, Face, Object, Group, and Hole. These modifiers affect the behavior of the tools on the palettes directly below it: the Pick tool (on a palette of its own), the Derivative tools, and the Mesh tools. (See the Topological Levels sidebar later in this chapter.)

The Derivative tools are unique and not found in many 3D programs. With them, you extract models from existing models or from parts of existing models. They mimic the functions of some of the drawing modifiers, but they modify objects or object parts after they are drawn. With these tools, you can extract or derive parts from existing models that match up perfectly against the faces or segments from which they are derived. Window frames can be derived from the drawn outline of a window, machine parts extruded from the faces of already existing parts, and so on. The derivative tools palette has tools, such as Revolve, Sweep, and Extrude, that are common to most 3D programs, although they are a bit more powerful here, because parts of objects can be pulled (swept) along a path that is part of the object itself. Piping along upholstery, for instance, can be created from an existing model of a seat cushion by extruding a shape along the path of the seam of the modeled upholstery itself, forming a perfect seam-fit.

There are several unique tools, such as the Terrain generator, the Section tool, the Parallel derivative tool, and the 2D derivative tool. In addition to its inherent accuracy, derivative modeling tools greatly speed the modeling process.

MetaTools Bryce

Bryce is a very slick program, costing about \$180 and is one of the best natural terrain creators available. Additionally, you can create 3D objects within the program and import 3D objects from other programs. Infini-D and form•Z also create terrains, but Bryce is the package for you if your focus is generating landscapes. Or, just get it to play with the interface—it's really cool!

Following the Derivative palette is the Mesh tools palette, a collection of tools for creating, modifying, deforming, and sculpting meshes. A mesh can be thought of as a collection of polygons subdividing large or complex model surfaces. Why would you want to add to the complexity of a model, since this would put even more demands on the CPU? Some operations,

particularly deformations, require a large number of polygons. They need a large amount of information in order to complete a complex deformation successfully. The tools on the Mesh palette are capable of creating plain meshes by subdividing faces of an object. Deformation tools include preset tools, such as linear and radial sine waves, for creating flag wave or pond ripple effects, randomizing effects for disturbing surface geometry, the Move Mesh tool for pushing user-defined shapes into or out of a meshed surface, and the geometric deformation tools, which include Twist, Bend, Bulge, Taper, Shear, and Bézier deformations. The C-Mesh and C-Curve tools (explained a bit more later) are also on this palette, along with tools for manipulating meshes, such as the Rounding, Direction, and Triangulate tools.

Irregularities, such as bumps and ripples, can be built into the surface of a couch model to create a truly organic, realistic model. For those who are using form•Z to create models for export to animation programs, the combination of “rumpled” geometry and bump-mapped texturing is a highly effective way to bring out the finer details of a surface.

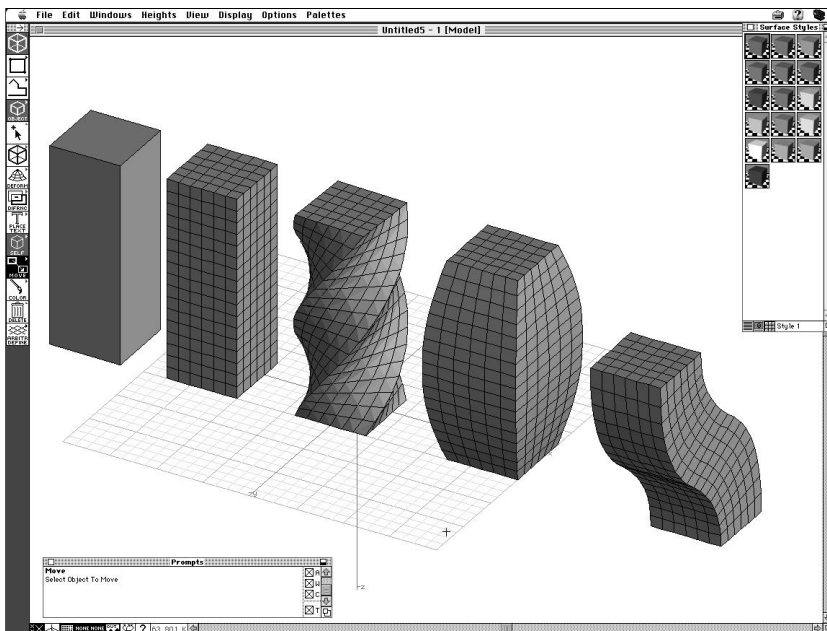

Figure 18.25
Simple deformations

Although these basic deformations can be accomplished in Infini-D, the real beauty of this feature is when you apply it to a model with many objects, such as a DNA chain. The chain might be bent as well as twisted, and can be modeled by first building the simple helix, meshing, and then deforming—now that's modeling power!

Surface vs. Solid Modeling

form•Z's major strength has always been that it is a surface and a solid modeler. This simply means that form•Z sees objects as having an inside and an outside, and they can contain volume, which is different from the way most 3D programs operate (Infini-D has a surface modeler). Most 3D software sees objects only as surfaces, so an object may be a cube but it has no volume, only an exterior shell. A cube in form•Z, on the other hand, can be a hollow surface object or a filled solid; and while they may look the same on the outside, the solid can be drilled, rounded, and whittled, and these operations will reveal a solid interior. The advantages of this kind of modeling cannot be underestimated: any object can be continually refined, and complex shapes can be built up very quickly using these methods.

As a surface modeler, form•Z has an extensive range of surface modeling tools as well. Shapes can be drawn using Nurbs—or spline-based drawing tools, and these entities, which form•Z calls C-Curves (Control Curves), can be adjusted or reshaped at any time in the modeling process. In addition, these spline-based shapes can be used as the framework of a more complex entity, the C-Mesh. A Control Mesh can be surface or solid, open or closed, and is a flexible mesh of polygons stretched over a lattice of Control Lines, which in turn are infinitely adjustable and editable...the control parameters are stored within the model and can be accessed and changed at any time during the modeling process. (Compare this to Infini-D's implementation of cross sections, paths, and rails. There are similarities, but form•Z takes it to the extreme—you do pay for it though.)

Modeling in form•Z

Within the program are two modules, Drafting and Modeling. In Drafting mode, 2D drawing tools are available (see Figure 18.26), and there is a full range of editable dimensioning tools. Artwork can be copied and pasted from Drafting to Modeling and vice versa. Structures built in this plan view can be pasted into the Modeler (see Figure 18.27) and extruded with height (see Figure 18.28), and models built in 3D can be copied in any view, including a variety of standard architectural viewpoints or any user-definable viewpoint imaginable, and that elevation can be pasted into Drafting to be dimensioned.

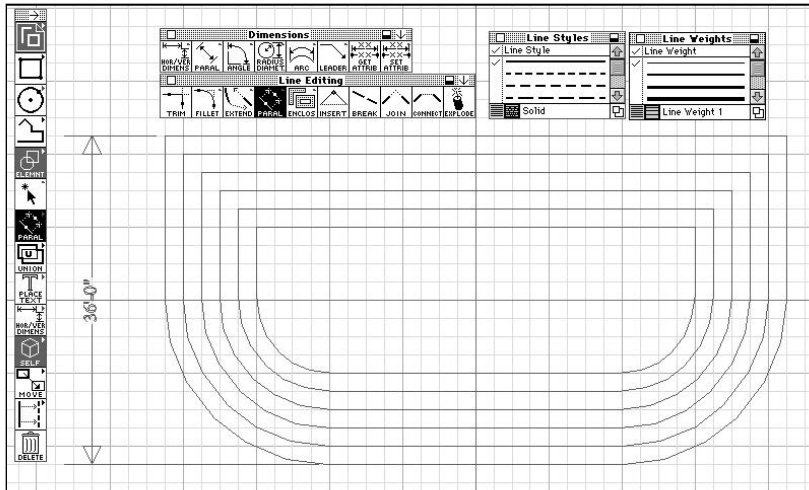

Figure 18.26
Drafting Module

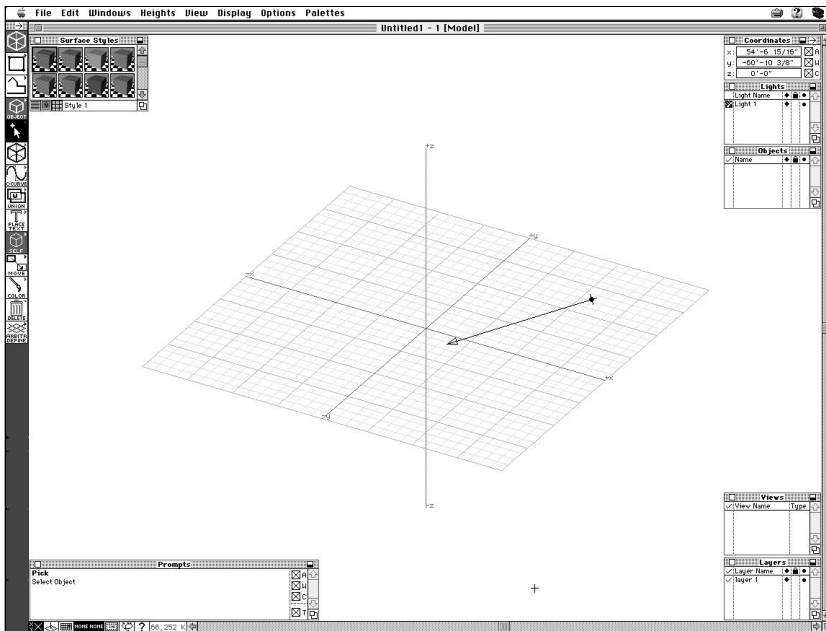

Figure 18.27
Modeling Module

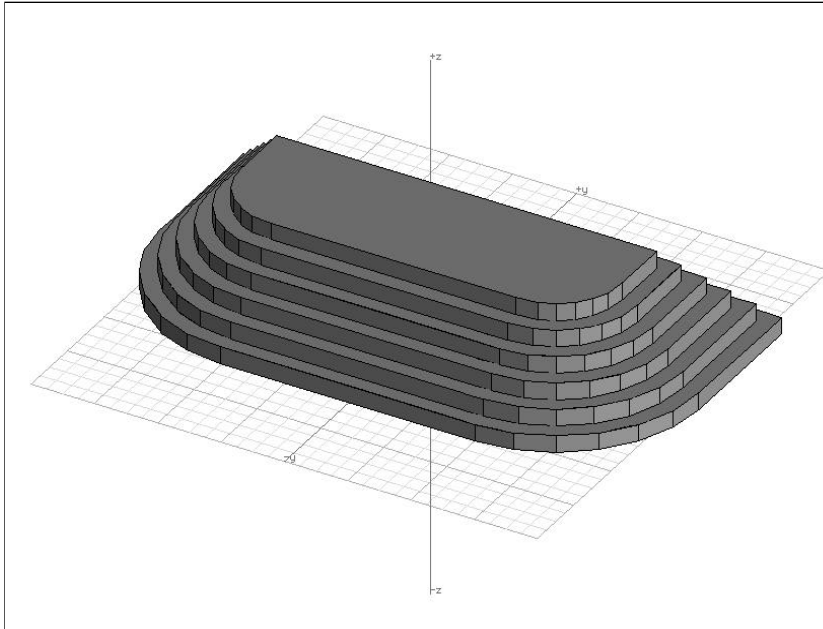

Figure 18.28
*The result of Figure 18.26
 after modeling.*

Boolean Modeling Tools

Boolean has become a bit of a catch phrase among model making programs, but form•Z still does them far better than anything else out there. Infini-D's Booleans have been well implemented, but fall short in how the negative objects relate to the positive object (i.e.: the holes in a bowling ball could not have rounded edges). Other programs have instituted Booleans, but they are either buggy, don't produce the expected results, or create badly formed models. Booleans are a necessity when creating any kind of complex model, particularly one with concave surfaces. A typical problem might be—well, remember that bowling ball mentioned earlier? How do you make holes that are drilled into a sphere, particularly with the kind of filleted edge typical of the way these holes are shaped in reality? With a powerful Boolean cutting tool like the Difference operator in form•Z or the Boolean Subtraction in Infini-D, you can position a cylinder to intersect the sphere where you want the hole and subtract it from the sphere. Then, using the Rounding tool in form•Z you can change the edge of the hole where it meets the surface of the sphere to produce a nice smooth contour and a realistic-looking beveled edge to the opening of the cylindrical hole. Figures 18.29 through 18.35 show this example created in form•Z. In Infini-D you would have to try to account for the rounding with the negative objects—not an easy task.

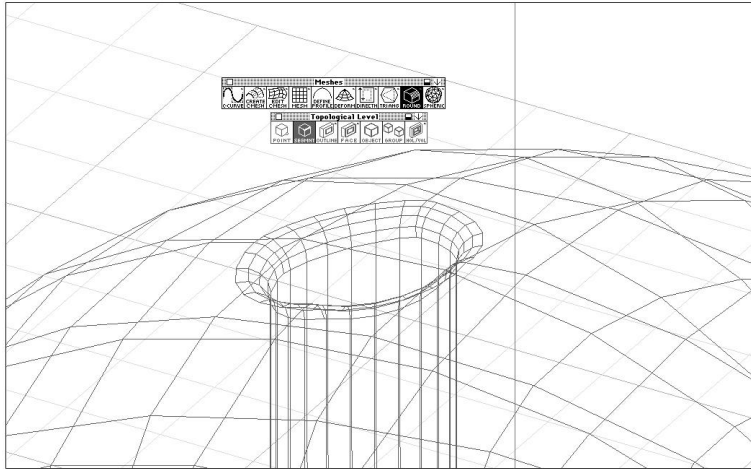

Figure 18.32

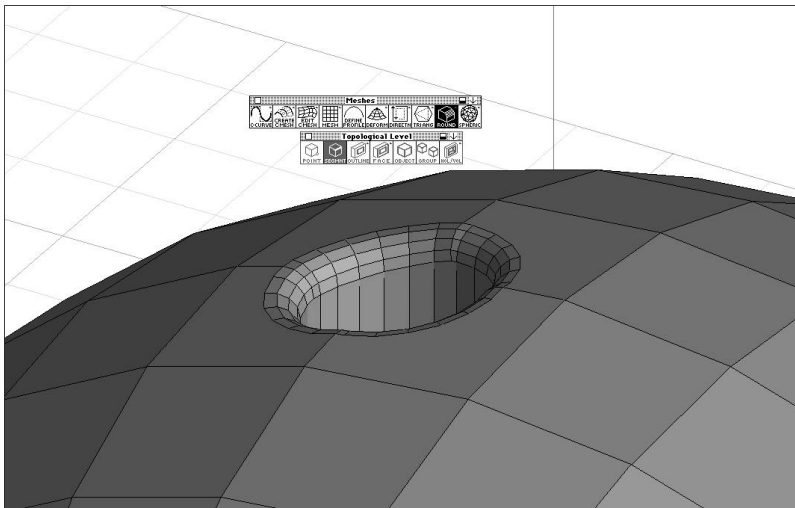

Figure 18.33

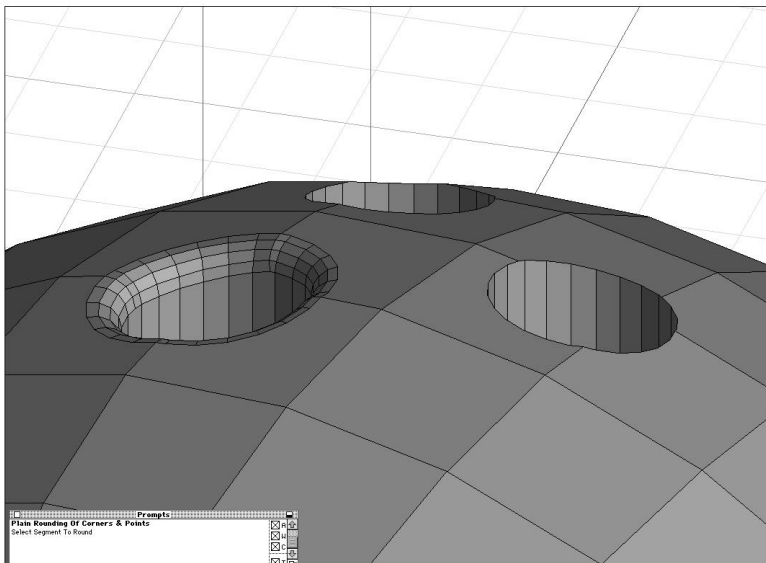
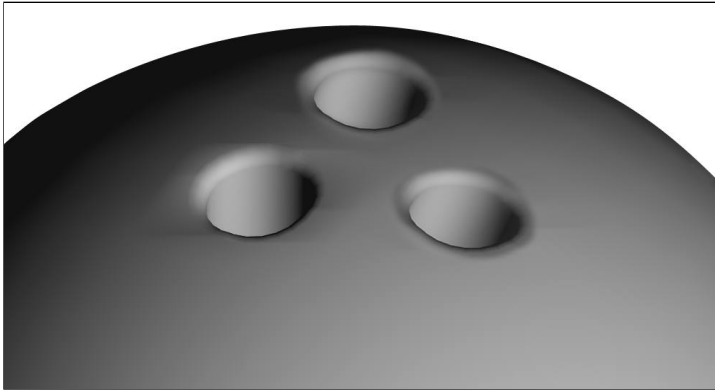

Figure 18.34

**Figure 18.35***Final rendered ball in form•Z.*

Topological Levels

In the bowling ball sidebar, the fact that you could select only the edge of a hole or the objects themselves that make up the model leads to an important feature for the very serious modeler: the capability to address an object on many different levels. In most standard modeling programs such as Strata or Infini-D, objects are objects and that's the only way you can get at them; you can't select just a face or a line segment and move it off the surface of the object, or pull on just one point to deform a polygon. There are functions, such as Strata's Facet command, that will break up an object into faces that can then be individually manipulated, but it's limited. In Infini-D, you must create the negative object to include the rounded information.

Because form•Z's setup is very modular, and no one tool performs only one operation, tools work in conjunction with tool modifiers to create whole new sets of tool functions, and one of the modifier sets is the Topological Level modifiers. The Topo modifiers are Object, Face, Segment, Point, Hole, Outline, and Group. The Object modifier is the default, but by selecting the Face modifier and using it in conjunction with the Rotate tool, one face of an Object can be rotated, or several of its faces can be rotated if they have been pre-selected. Topological Level modifiers can be applied to any of the transformation tools such as the Move, Scale, or Mirror tool, and these tools can then be used to manipulate only portions of an object.

Another set of modifiers is the Self-Copy modifiers, which modify whether a tool acts on an object (or Face, or Hole, and so on) or on a copy of that object. form•Z does not use the standard Mac Option+drag to create a copy, so there is an extra mouse click to select the Copy modifier.

Modifiers can be used in conjunction with each other to create more combinations and increase tool functionality. The Move tool modified by the Hole Topological Level modifier and the Copy modifier will move copies of holes through an Object...And that's how the second and third holes were created in the bowling ball, by simply copy-moving the first one.

If You Need Help

The complexity of form•Z and its options are mitigated by a multifaceted, built-in help system, consisting of the Prompts palette, the Error dialog, and the Help command. The Prompts palette is a floating palette that interactively records the position of the cursor in X, Y, and Z coordinates, identifies the tool you have picked, prompts you for what you need to do next with the tool, and tells you what you've just done. You can also key coordinates into the Prompts palette if you prefer greater accuracy than moving the mouse to set a point or perform some transformation. All the information in the Prompts palette is recorded throughout the working session, and can be scrolled through to check what you've done, or alternately can be saved into a text file for future reference. All actions can be undone back to the last saved version of the program; there is no limit on the Undo command.

Import/Export

OK, form•Z is both Mac- and PC-compatible, but we admit a Mac bias. One of the great things about the Mac is the cross-application compatibility. Rarely does a project use only one program; more likely four or five programs for modeling, texture mapping, animating, post processing, and translating for output to various mediums or platforms can be easily used. So the Mac's still-user-friendliest interface is definitely a winner.

Having said that, it should be pointed out that 3D file transfer and compatibility is not always the easiest thing to accomplish, even from one Mac program to another, never mind cross-platform. DXF, the standard format of all 3D programs (the EPS of the 3D world) is the common denominator, but not all 3D programs interpret DXF the same way. Models exported from one program may show up in another with faces missing, or won't render smoothly. Why export models at all? Well, some programs do some things better than other programs. form•Z has its strengths, and is probably the best all-purpose modeler on the Mac platform. But even form•Z has to export in order to have the models animated. That means exporting to some format other than form•Z's native format, because currently there are no other programs on the market that read form•Z files directly.

The choices in animation programs are fairly numerous. Some of the most popular programs for animation are Infini-D, Strata3D, and ElectricImage, just to name a few. Infini-D and Strata both import DXF and 3DMF (Apple's QuickDraw 3D Metafile format) and form•Z exports both of these along with about a dozen other of the most popular formats. ElectricImage imports many formats, but its native file format is called FACT, which form•Z also exports.

Why choose one format over another? Some formats are more efficient than others, in terms of disk space and the time it takes to render those models. There are issues of hierarchy, grouping, and file organization, which are handled better by some formats than by others.

ElectricImage Animation System

ElectricImage is the only professional-level animation and rendering system available on the Mac platform. It consistently produces animation of broadcast quality under typical production environment deadline pressure. Dave's personal benchmark for a rendering program to be useful is that it has to be able to render at least 30 seconds of interlaced, NTSC D1 resolution animation (720×486 pixels) overnight, even with fairly complex projects. With that kind of capability you can keep a lot of promises to clients who want to make revisions as deadlines draw near, and that would pretty much include all clients.

Speed does distinguish ElectricImage from the rest of the Mac pack, and it's not exaggerating to say that it renders 15 to 25 times faster than its closest competitor. Its speed rivals many programs on the SGI platform as well. But there are other considerations in choosing a renderer/animation system; for instance, the quality of renderings from 3D Studio are not nearly that of ElectricImage, so even if it was as fast (and it isn't) it still is not appropriate for broadcast-level projects. There are other features to look for, such as integrated special effects like particles (see Figure 18.36) and explosion; lighting features such as atmospheric rays, fog and glow; and individual cell-by-cell numerical control over every possible animated parameter of an object.

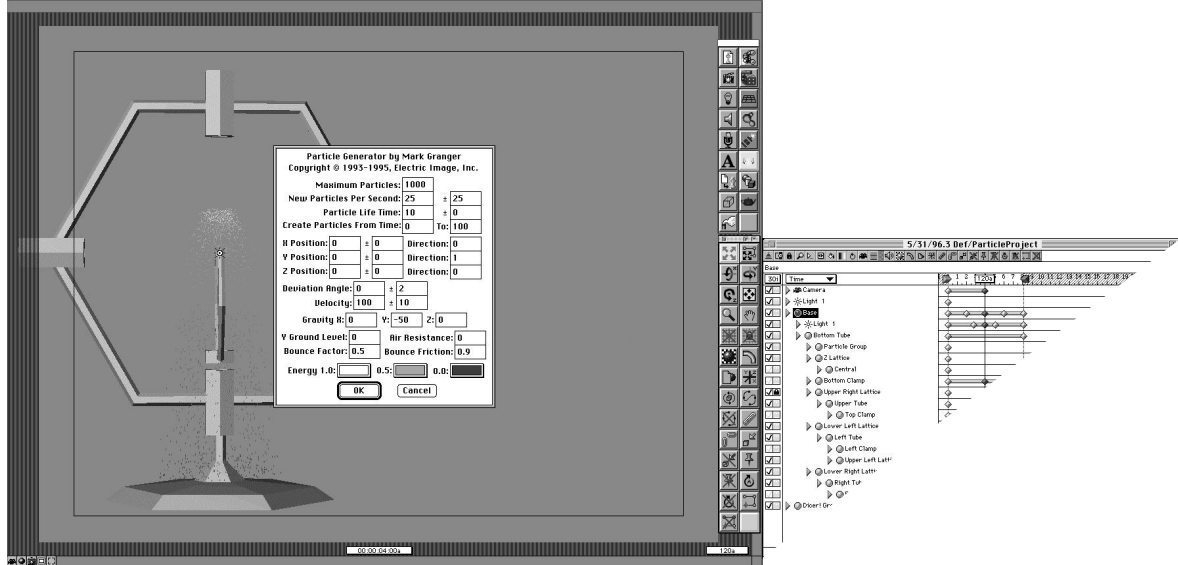

Figure 18.36
ElectricImage's particle generator

ElectricImage has a very well thought out interface, which makes it possible for beginning users, especially those with some 3D experience, to jump right in and intuitively understand how to start animating; it also has the kind of depth that can take years to master completely, but anyone can be productive with it very quickly.

Until now, the program's \$7,500 price tag has put it out of reach of all but the most successful independent animators, but anyone who has made the commitment has made the money back very quickly. Now, the broadcast and scholastic editions make it reachable by many more designers and animators. The only difference between the Film and the Broadcast versions is that Broadcast renders animation only up to broadcast resolution (NTSC 720×486, PAL at 768×576). It will render high-res stills, but only the Film version will render high-res animation. Future releases may see more features in Film than are available in Broadcast, however. The Scholastic version renders only up to 512×384 pixels and its file format is not compatible with the other versions of EI. But this size frame is more than enough for multimedia applications—so it's a nice way to get your feet wet. There are also Slave Cameras available. These remote rendering engines are priced at \$500 (Broadcast) and \$1,500 (Film), and will render animations on remote machines over a network.

It's hard to talk about ElectricImage without coming back again and again to the issue of speed. 3D rendering is such a time-intensive process that even a single independent animator needs multiple workstations to get any real work done. One station can be tied up for hours or days depending on the length and complexity of the animation it's cranking out. Productivity is directly related to how fast you can get it done, and the added bonus of speed is that test renders are so quick, there's time for experimentation, which leads inevitably to better looking pieces and more creative accomplishment.

Part of the program's power is its capability to digest huge amounts of data. Enormous modeled environments, typical of CD-ROM production, together with hundreds of megabytes of texture maps and dozens of lights would bring down almost any 3D program on any personal computer, even a Power Mac.

Features

ElectricImage has four working view windows similar to that of Infini-D: the World View windows (Front, Right, Top) and the Camera View window, each with controls for zooming, scrolling, and for rendering test animations with many options of format, bit depth, and frame rate. The Camera window has Orbit, Track, Zoom, Pan, and Dolly controls for manipulating the camera (although this can also be done from the other World View windows) and has such added niceties as superimposed Action and Title safety grids, plus the capability to see what's happening outside of the camera's view, so you can see past what's actually being rendered and are able to preview what's coming in from out-of-frame.

The Project window is the timeline. This is where all models, their groups, hierarchy and links are established. Keyframes are set for motion and all other animated parameters. The Project window can be viewed in one of four ways. The two most often used: Time mode (see Figure 18.37) shows graphical keyframe icons which can be dragged to different points on the timeline to adjust motion (similar to Infini-D's time-based Sequencer). In Keyframe or Frame mode (see Figure 18.38), the Project is displayed as an Excel-style spreadsheet, with each cell of animation data visible and editable for each Group in the project (EI refers to each object as a Group). The Project window has its own set of tools for manipulating timeline data, such as Blend, Randomize, Jolt, Spring, Oscillate, and Repeat tools that operate on a selected range of cells to automatically and easily alter data. All Groups, Lights, and the Camera have spline-based velocity windows to control ease-in and ease-out graphically, and all motion paths are visible and have Illustrator-style Bézier handles at keyframes. This enables a full preview as well as an intuitive way to tweak animation paths in 3 dimensions.

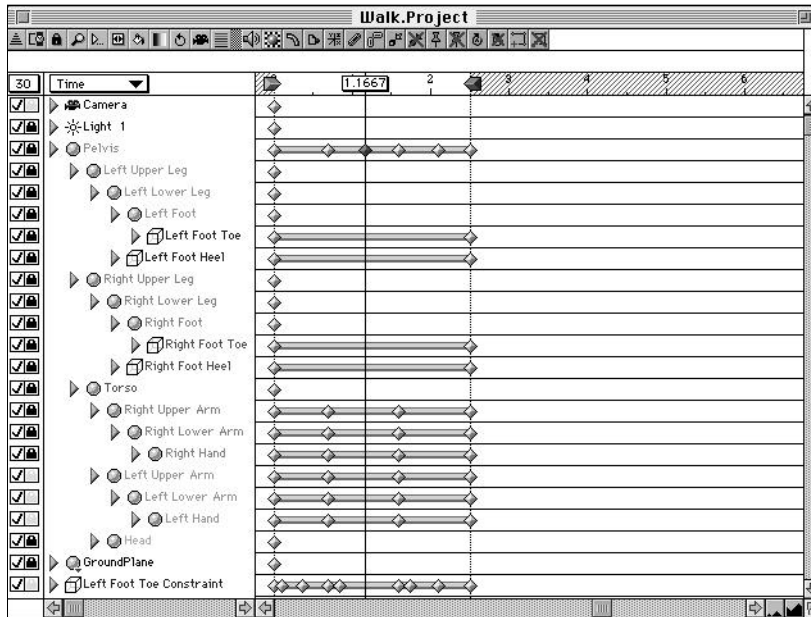

Figure 18.37
Time Line Mode

Each Group has several associated dialogs to control surface material, surface texture, linking and link constraints, and deformations. Material Editing (see Figure 18.39) is deep and each parameter can be animated—luminosity, diffuse, ambient, reflective lighting, color, transparency, and edge density are all keyframable. Currently, each group can have two texture maps, each map with its own alpha channel, and one reflection map. Maps imported into the Texture Editor (see Figure 18.40) control the surface mapping of a Group, but also can be configured to modulate the bump grain of a Group, or any of the lighting characteristics. A map, for instance, can be assigned to the specular property of a Group to define where it will be shiny and where it won't.

Walk Project

Light 1		32	33	34	35	36	37	38
30	Keyframe							
<input checked="" type="checkbox"/>	Camera							
<input checked="" type="checkbox"/>	Light 1							
<input checked="" type="checkbox"/>	Pelvis							
	Attach	None	None	None	None	None	None	None
	Track	None	None	None	None	None	None	None
	Auto-Rotate	None	None	None	None	None	None	None
	Auto IK	None	None	None	None	None	None	None
	Visibility	On	On	On	On	On	On	On
	Position							
	Motion Path	Bezier	Bezier	Bezier	Bezier	Bezier	Bezier	Bezier
	Velocity	333.057	337.5796	340.5553	341.6279	347.2412	360.4542	376.5401
	Acceleration	0.0	0.0	0.0	0.0	0.0	0.0	0.0
	X	0.0	0.0	0.0	0.0	0.0	0.0	0.0
	Y	16.3715	16.2175	16.0665	16.0	16.1456	16.494	16.9384
	Z	-274.3418	-285.5095	-296.8241	-308.199	-319.6389	-331.3878	-343.6736
	Center							
	X Rotation							
	Y Rotation							
	Z Rotation							
	X Scale							
	Y Scale							
	Z Scale							
	Color							

Figure 18.38
Key Frame Mode

Standard Shape Group Material

Edit Keyframe Group Attributes of "Standard Shape"

Type:

Attribute:

Group Color

Diffuse

Ambient

Specular 200.0

Reflectivity

Luminance

Transparency

Edge Density 0.0

Shading Dropoff 1.0

Specular Dropoff 1.0

Modify in:

Figure 18.39
Material Editor

Standard Shape Group Texture

Texture Name:

Texture 1: O2a Gameboard Movie2 Fra

Texture 2:

Reflection:

Map type:

ROB:

Alpha:

Align:

Softness:

Map Filter:

Size: 1280 x 960

Bits/pixel: 32

Still frame

Repeat X

Repeat Y

Mirror X

Mirror Y

Negative Z

Enable Filter

Position: X: 0.0, Y: 0.0, Z: 0.0

Rotation: X: -90.0, Y: 0.0, Z: 0.0

Flat: X Scale: 0.1562, Y Scale: 0.2083, Z Scale: 0.2083

Mip Density: 1.0

Mip Maximum: 0

Bump Factor: 1.0

Figure 18.40
Texture Editor

Import, Hierarchy and Linking

When models are animated, they often need to be linked hierarchically in a kind of family tree so that some objects (the parent objects) have control over the motion of other objects (the children). A simple example would be a model of a human mannequin (see Figure 18.41). The upper arm would link to the torso, the lower arm to the upper arm, and the hand to the lower arm. Moving the upper arm moves the lower arm and hand with it—they are both children (or grandchildren) of the upper arm. You would also want to set rotational constraints for this kind of model, so that an elbow would not bend backwards on itself. There are many presets in the Linking dialog, such as setting a joint as “Socket,” “Pin,” “Universal,” “Free,” or “Lock,” and there are also sets of human style joints that can be applied—appropriately named elbow, knee, and so on for the joints they would represent in the model.

EI goes one step further by incorporating Inverse Kinematics, a feature generally found only in high-end animation programs. With Inverse Kinematics, or IK, motion can be controlled from the children as well as from the parent objects. So to have this mannequin turn off a switch, he can be grabbed by his index finger and pulled toward the switch; the arm and body will follow until they reach their limit of movement as set in their Link settings. This method is vital for character animation and makes it much easier to accomplish.

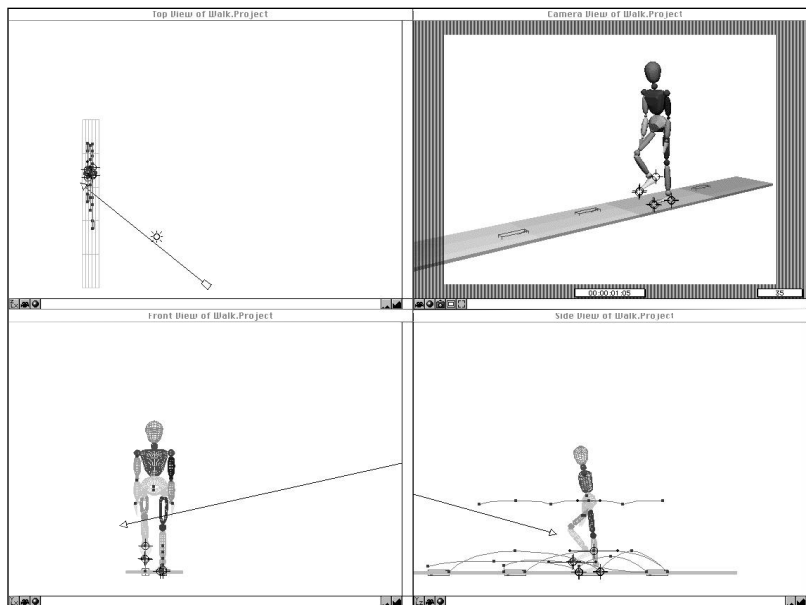

Figure 18.41
A human mannequin animated in *ElectricImage*.

Character Animation

For those of you who do not have the big bucks to spend on *ElectricImage*, another package that allows for great character animation is Martin Hash's 3-Dimensional Animation. This little program packs a powerful punch for a mere \$199. The biggest obstacle to us Mac bigots is that the interface is very unMac-like. And there is little in the way of documentation. But, if you are willing to dive right in and get around the interface, this is the program to allow you to create very effective character animation (inverse kinematics included)! Additionally, Hash's features include spline-based modeling and seamless skinning among others. The last time I checked, their Web site included some additional documentation and tutorial information.

As mentioned earlier, form•Z and ElectricImage work well in combination. It's beyond the scope of this chapter to go into all of the import/export options of each program, but it's worth pointing out that that form•Z will export in FACT format (ElectricImage's native format), and that all hierarchical parent-child groupings that were set up in form•Z will carry over to ElectricImage, along with the absolute world coordinates, orientation and centroids of the models, the names of the various groupings, even the colors of individual polygons, all come into EI intact.

Once imported into ElectricImage the models can have their hierarchy restructured if necessary, and group centers can be reoriented and links then set up. Group centers can even be animated, to create eccentric orbits.

ElectricImage reads model and texture files from disk without actually loading them into a scene the way Strata and some other programs do; if adjustments are necessary to the model file, the original is opened in form•Z and rewritten to the same folder with the same name. This loads in the new model but all the animation and texture parameters that were set in EI remain intact. If a model has been imported, texture mapped, and animated, and then that model is updated, the new model has all the mapping and animation still applied.

Extensibility

Plug-ins, which became popular with Photoshop many years ago, are small bits of code, mini-programs, which when placed in an appropriate folder within an application's folder, load when that program launches. ElectricImage ships with a dozen or so plug-in modules, some of them very powerful, for creating particle fountains, explosions, lens flares, smoke and clouds, metaballs, and animated mesh objects such as breathing cylinders and planes that wrap to become spheres. There are also a number of third-party plug-ins on the market: Tree Pro, the wonderful tree-growing software from Onyx, makes a plug-in that will grow trees from within EI, and will create them as low-res proxy models, replacing them with the full-res tree models when it's time to do the final render. Northern Lights markets several plug-ins for creating complex lightning, starfield, fire, and particle systems, and a company by the name of Olbicard markets Image2Mesh, a plug-in for transforming images or movies into animated terrain-like models.

Using form•Z and ElectricImage

The Health Rider

Animation for the Health Rider broadcast infomercial was of a mechanical exercise bike, made up of 13 interlocking, animated parts. (See Figures 18.42 through 18.45.) Accuracy was essential or parts would be flying all over the place during the animating process. As simple as this might look, there were some very critical design considerations:

- The piece we were to animate was a black bike with black rubber accessories shot against a black background. Special attention had to be paid to texture and surface control to keep the bike from disappearing, and to maintain a dramatic and interesting look. Modeling techniques were also employed to enhance rendering; every edge of every part was beveled to catch the light as the camera orbited around the bike.
- The bike was “shot” from extremely close camera angles—so close that the camera’s motion had to be timed to the bike’s to avoid bumping into moving parts.

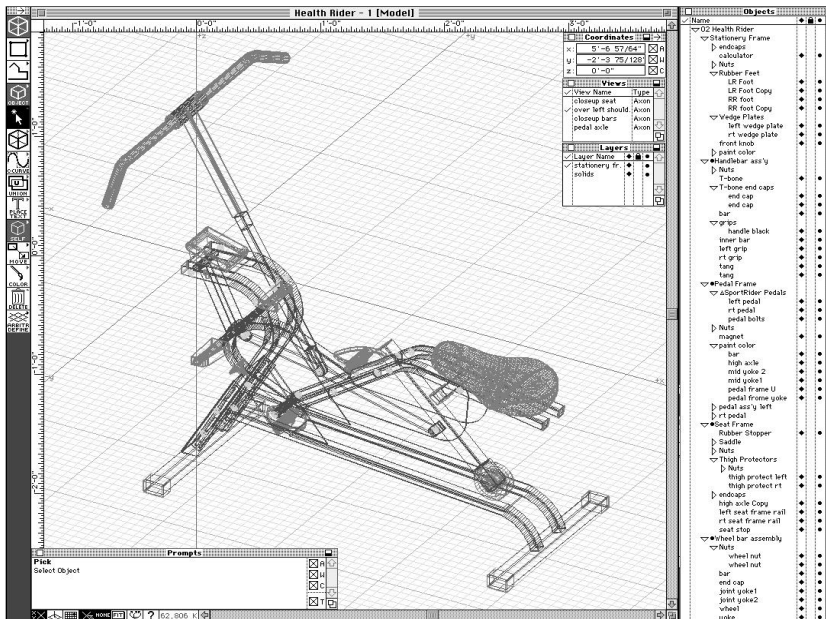

Figure 18.42
Health Rider model.
©1995 Dave Teich
Mind of the Machine



Figure 18.43
Health Rider rendering.
©1995 Dave Teich-Mind of the Machine

Figure 18.44
Health Rider pedal close-up.
©1995 Dave Teich-Mind of the Machine

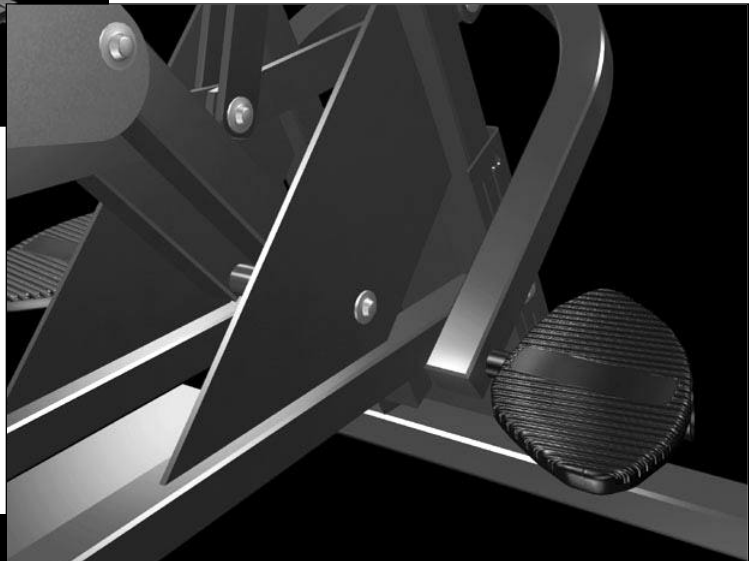

Figure 18.45
Health Rider calculator close-up.
©1995 Dave Teich
Mind of the Machine

We had three months to produce 20 minutes of D1 resolution animation. This project was produced using two copies of ElectricImage and three slave rendering engines on desktop Power Mac computers without any special acceleration hardware. The project staff included one full-time modeler/ animator and two part-time animators. The process for modeling and animating technical subjects is somewhat different from purely design-oriented work in which the animator's intuition and ability to communicate an idea are all that is necessary. Animating a product, such as the Health Rider—an exercise bike with 13 moving, synchronized interlocking assemblies—requires careful planning and preparation, and extreme attention to detail.

HORDE Concert Tour CD

HORDE, like Lollapalooza, is a group of bands that tours the U.S. each summer. This double CD set includes one disc of music and video shot on tour; the second disc is an interactive environment replicating the entire tour grounds, including all of the tents, tour buses, shops, equipment vans, and a 40-foot long carved humpback whale. (See Figures 18.46 through 18.50.) QuickTime VR is used extensively throughout the environment, as is blue screen compositing of video with 3D elements. The model, consisting of more than two million polygons, was constructed using form•Z and rendered in ElectricImage. The buildings and vehicles are so detailed that file management alone became a problem in and of itself, not to mention the need for speed of delivery. The layering and hierarchical grouping functions, as well as the export capabilities, were absolute necessities in a project of this size. Despite the enormous demands created by this size model—models and textures totaling 900MB of data, which needed 200MB of RAM to open—frames rendered in five to six minutes each within ElectricImage.

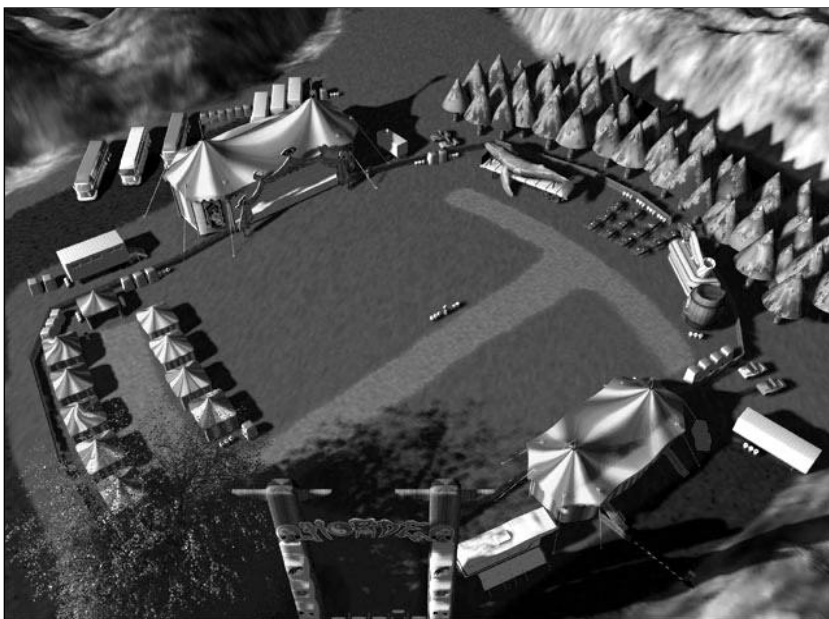

Figure 18.46
*Aerial view of Horde CD
landscape.
Dave Teich for Fischer
Multimedia Arts and
Philips Media ©1995
Mind of the Machine*



Figure 18.47
*Main stage of Horde CD.
Dave Teich for Fischer
Multimedia Arts and
Philips Media ©1995
Mind of the Machine*



Figure 18.48
*Main gate of Horde CD.
Dave Teich for Fischer
Multimedia Arts and
Philips Media ©1995
Mind of the Machine*

**Figure 18.49***Keg interior.*

©1995 Dave Teich

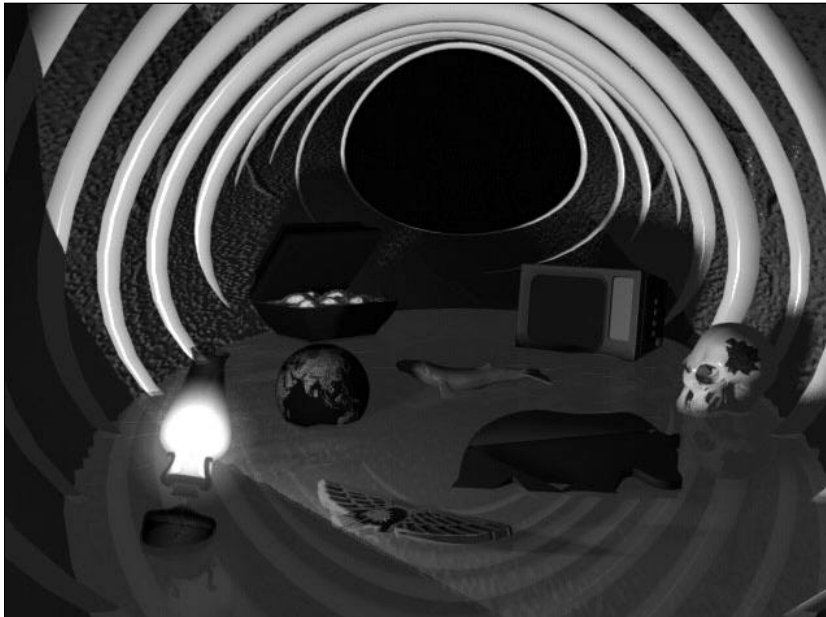
Mind of the Machine**Figure 18.50***Whale Interior.*

©1995 Dave Teich

Mind of the Machine

Summation

Part of the problem with working in 3D (especially if you have little or no experience) is that it is hard to decide which product to use. To crudely generalize, if all you are doing is simple flying logos or uncomplicated scenes, LogoMotion is the product for you. But, there is a point at which you need the more sophisticated features of Infini-D. And then, when projects demand exacting precision, complicated models and animation or are just plain huge, form•Z and Electric Image may be the combination you crave. You have to make some decisions as to which features you want and need. Balance that with your system's capabilities and your bank account and you have the ideal combination. Realizing that that is not an easy task, we've included a feature comparison of the programs to help you decide:

Features Comparison

X = yes - = no

A=Film version

B=Broadcast version

C=Educational version

	LogoMotion	Infini-D	form•Z	Electric Image
	2.0.1	3.5	2.8	2.7
Import Capabilities ¹				
Objects/Shapes				
Illustrator	X	X	X	-
EPS ²	X	X	X	-
DXF	X	X	X	X
Swivel	X	X	-	-
3D MetaFile	X	X	X	X
FACT	-	-	X	X
Images/movies as texture and/or image maps				
PICT	-	X	X	X
TIFF	-	X	X	-
PICS	-	X	-	-
QuickTime	-	X	-	X
Image	-	X	-	A B C
				low-res only
Multiple Images	-	X	X	X
Export Capabilities				
Objects				
3DMF	X	X	X	X
DXF	X	X	X	X
FACT	-	-	X	X
Rendering				
QuickTime	X	X	-	X
PICT	X	X	X	-
Compressed PICT	X	X	-	-
TIFF	X	X	X	-
PICS	X	X	-	-
Image	-	-	-	A B

¹ Because of the large number of import and export capabilities of both form•Z and ElectricImage, only the most common Macintosh formats have been listed here. Both of these programs support formats for the PC, SGI and others.

² 3rd-party plug-ins available soon.

Modeling³				
Surface	X	X	X	limited
Solid	-	-	X	-
Primitives ⁴	X	X	X	X
Custom Models				
Spline	-	X	X	-
Vertex (point/polygon)	X	-	X	-
C-Mesh	-	-	X	-
Derivative	-	-	X	-
Bevels	limited to simple extrusions	limited to simple extrusions	X	-
Boolean Functions (Boolean Operators)				
	-	X	X	-
Edge Rounding ⁵	-	-	X	-
Hierarchical Linking	X	X	X	X
Grouping	-	-	X	X
Multiple Lights	limited	X	X	X
Multiple Cameras	-	X	-	-
Rendering				
Lights				
Point ⁶	X	X	X	X
Spot ⁷	X	X	X	X
Tube ⁸	-	-	-	X
Camera ⁹	-	-	-	X
Ambient ¹⁰	X	X	X	X
Distant ¹¹	-	X	X	X
Change color and intensity	X	X	X	X

³ Because objects are categorized differently in each program, it is hard to compare each object to the way it is created and edited. Therefore, this list is very general.

⁴ Basic objects that render faster than custom objects.

⁵ Edge rounding is often used after performing a Boolean operation on objects. It rounds the area where the objects meet to give the connection a more natural look.

⁶ Works like a lightbulb.

⁷ Works like a theater spotlight.

⁸ Generates a tube-like effect; i.e. fluorescent tubes or laser beams.

⁹ Attaches to a camera and moves as the camera does.

¹⁰ Light that doesn't come from any particular place—like the light in a room during the day when the shades are drawn.

¹¹ Light that comes from a specific, distant place and casts parallel shadows—like the sun. This is called a parallel light in ElectricImage.

Cast Shadows (or not)	X	X	X	A B C not high-res
Masks (gobo effects)	-	X	-	X
Gels ¹²	-	X	-	X
Rays ¹³	-	-	-	X
Lens Flare	-	X	-	A B
Composed Surfaces (complex surfaces) ¹⁴	-	X	X	limited
Fog	X	X	X	X
Smoke	-	-	-	X
Procedural Surfaces	limited	X	X	limited
Shading/Rendering Modes				
Bounding Box	X	X	-	X
Wireframe	X	X	X	X
Flat Shade ¹⁵	X	X	X	X
Gourard Shading ¹⁶	X	X	X	X
Phong Shading ¹⁷	X	with transparency	X	with transparency and true reflections
Ray Tracing ¹⁸	-	X	X	-
QuickDraw 3D Support	limited	X	-	-
Anti-alias levels				
Off	X	X	X	X
Low	-	X	X	X
Medium	-	X	X	X
High	X	X	X	X
Use Alpha Channels from Image Files	-	X	X	X
Render				
Alpha Channels	X	X	X	X
Morphing	very limited	X	-	very limited
Background Images	X	X	X	X

12 A colored film over a light—this can be an image as well.

13 Beams or volumetric lighting.

14 Used for combining multiple surfaces on objects and controlling how the surfaces map to the object.

15 Called Shade Fast in LogoMotion and Infini-D.

16 Called Shade Better in LogoMotion and Infini-D.

17 Called Shade Best in LogoMotion and Infini-D.

18 Very high quality rendering with transparency and true reflections.

Motion Vector Blur	-	-	-	A B C limited
ShadowCatchers or equivalent	-	X	-	X
Soft Shadows	-	-	X	X
Built-in Title Safe/Action Safe Indicators	-	X	-	X
Field Rendering	-	-	-	X
Frame Size Limit (in pixels)				A 16K+ × 16K+ B 768×576 & high-res stills C 512×384
Network Rendering	X	X	-	A B
Animation				
Automated Objects ¹⁹	X	X	-	-
Rotoscoping ²⁰	X	X	-	X
Spline-based Motion Paths	very limited	limited	-	X
Velocity Controls	-	X	-	X
Inverse Kinematics	-	-	-	X
Particles	-	-	-	X
Metaballs ²¹	-	-	-	X
Explosions	-	-	-	X
VRML Support	-	X	-	manual

19 StageHands in LogoMotion allow you to add backdrops, moving lights, moving cameras and moving objects with the click of a button. These can be from the built-in list or those you create yourself. Animation Assistants in Infini-D allow you to create animations more easily. Everything is customizable to your specific needs.

20 The ability to map other moving images to objects, such as a QuickTime movie.

21 The ability to break apart complete modeles (multiple objects) into smaller ball-like objects.

The World Wide Web

Get yourself hooked up to the Web if you haven't already. There is so much great information out there. All of the companies mentioned in this chapter have their own Web sites, and they update them regularly with new information and files you can download. Many of them also have forums on America Online and CompuServe.

Web Site Addresses	America Online
http://www.apple.com	apple
http://www.specular.com	specular
http://www.adobe.com	adobe
http://www.formz.com	formz
http://www.electricimg.com	electricimage
http://www.macromedia.com	macromedia
http://www.equilibrium.com	-
http://www.hash.com	-
http://www.onyxtree.com	-
http://users.aol.com/olbicard/index.html	-
Northern Lights information can be found at the ElectricImage Web site.	

Among Some of the Best Books Out There:

Title: *Learn 3D Design on the Macintosh: Featuring Infini-D*

Author: Michelle Szabo

Publisher: John Wiley & Sons, Inc.

<http://www.wiley.com/compbooks>

(You didn't think I'd let the opportunity slip by did you?)

Title: *Infini-D Revealed*

Author: Brenden Donohoe & Adam Lavine

Publisher: Hayden Books

<http://www.mcp.com/hayden/multimedia/index.html>

Title: *Advanced 3D Design on the Macintosh: Featuring form•Z and ElectricImage*

Author: Dave Teich & Michelle Szabo

Publisher: To be determined—early 1997 publication (looking for beta testers for the book—users new to 3D welcome and encouraged)

Visit our Web sites to get updated information:

<http://www.newmediadesigns.com>

<http://bird.taponline.com/mindmachine/mom.html>

Title: *Animation and 3D Modeling on the Mac*

Author: Don & Melora Foley

Publisher: Peachpit Press

<http://www.peachpit.com/peachpit/titles/catalog>

19

Multimedia

Introduction: Media on the Desktop

Way back in the early 90s, creating an interactive multimedia program was ridiculously tough. Nothing worked the way it was supposed to; duct tape and aspirin were part of every developer's toolkit. But that's history. Not only is it much easier to develop multimedia today, it's a thrill. Breathing life into animation, editing the perfect sound loop, and cutting your own little music video are all possible with even the most average of Macintosh systems. Sure, there's a learning curve, several of them, actually. But the tools are mature now, which means you get to spend most of your time being creative.

If you want to know... Go to...

What is the best file format for cross-platform digital audio?	463
What is the difference between monitor and image depth?	452
Do I have to buy expensive hardware for video compression?	465
How do I convert graphics to 8-bit?	454
How do I create animation?	469
How does MIDI work?	456
What can I do to optimize my graphics for the Web?	471
How can I shoot better QuickTime movies?	468
What sort of hardware will I need for multimedia authoring?	447

How Many Hats Will You Wear?

After you've planned and designed a multimedia project, you build the program in three main steps: creating media (graphics, sounds, animation, videos, text), integrating the media in an authoring tool, and preparing the final multimedia program for delivery on CD-ROM, hard disk, diskette, or the Internet.

Can one person do it all? Probably not, and definitely not on a deadline. Virtually all commercial CD-ROM titles today are built by teams. A typical development team includes one or more people in each of these categories: production management, design, art/visuals, sound and music, and programming. Art tends to involve the most people; still graphics, animation, and video are usually the most time-consuming elements to produce.

But that's not to say one person *can't* do it. With enough time and skills, a creative, motivated (and perhaps *caffeinated*) artist could build a fairly sophisticated piece. Plenty of in-house development for marketing CD-ROMs, trade show kiosks, computer-based training, sales presentations, and the Web is going on within one-person multimedia departments. In fact, more and more these days you find people doing multimedia who *aren't* in a multimedia department. It's just a form of communication they do as part of their normal job.



Figure 19.1

Most multimedia CD-ROMs, such as Virgin Sound & Vision's *TerraTopia* game, are built by a team that includes producers, designers, artists, programmers, video editors, and sound designers.

Setting Up a Multimedia System

Hardware

Minimum

- PowerPC 6100 or greater
- 14" monitor
- 32MB RAM
- 1 Gigabyte hard drive
- CD-ROM drive
- Multimedia speakers
- Zip or Syquest drive

Better

- PowerPC 8500
- 80MB RAM
- 4 Gigabyte hard drive
- CD-ROM drive
- Multimedia speakers
- Digital camera (such as Apple QuickTake)
- Color scanner
- Hi-8 video camera* or VHS deck
- Radius VideoVision or Media100 card*
- AudioMedia II card
- Jaz drive
- AV-optimized disk array*
- IBM-compatible PC running Windows 3.1 or Windows 95 (for cross-platform testing)

** if you will be digitizing video*

Software

Necessary for editing, even if you don't intend to create your own media

- Adobe Photoshop
- Macromedia Director
- Macromedia SoundEdit 16
- Adobe Premiere
- Equilibrium Debabelizer

Optional

- 3D modeling and rendering package (for example, Macromedia Extreme 3D)
- Adobe After Effects
- Inspiration (flow chart diagrams)

Ratings

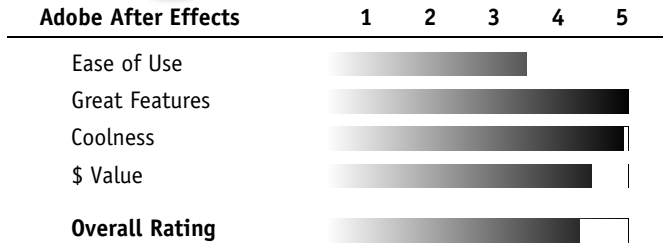

The Multimedia Production Process

The following is a very rough estimate of how you'll spend your time in multimedia production:

30% planning the program (and redesign)

20% media creation (or gathering)

20% integration and programming

30% testing, testing, testing, and preparing for final delivery

Planning the Program

This chapter is really about the production process rather than the artistic and conceptual design of your program, but there are some crucial decisions you'll have to make before you can start building (or gathering) your media.

Question 1. How will this program be delivered? (CD-ROM, Internet, and so on.)

Question 2. What are the minimum system requirements for playback? (In other words, what is the slowest machine on which your program will have to run?)

If your program has to run on a diskette, you have to be excruciatingly careful in planning your media. With only 1,400KB on a diskette, you can forget that 3D fly-in logo with the killer soundtrack. A single minute of less-than-CD-quality audio would still put you over the limit—and that's without any graphics! But there are developers who've made an art form of diskette delivery; they specialize in what's referred to as an Interactive Press Kit (IPK).

Although there are growing numbers of CD-ROM-based press kits being created, the beauty of the diskette-based kit is in how quickly (and cheaply) it can be built, reproduced, and distributed. Best of all, the diskette kit

is the perfect size for downloading from an online service. America Online and CompuServe, for example, both offer Hollywood Online—a forum that distributes press kits for feature films.

Ironically, just as CD-ROMs have begun to erode the diskette-based presentation market, along comes Web playback. The latest browser plug-in technology, which allows multimedia programs to be played back directly from a World Wide Web page (as opposed to downloading an IPK and then installing it on your machine) is a major step back on space constraints. Today's low bandwidth makes diskettes, with their meager 1,400KB, seem downright decadent. Tips and tricks for squeezing an interactive program onto a diskette or the Web are in the Special Delivery section of this chapter.

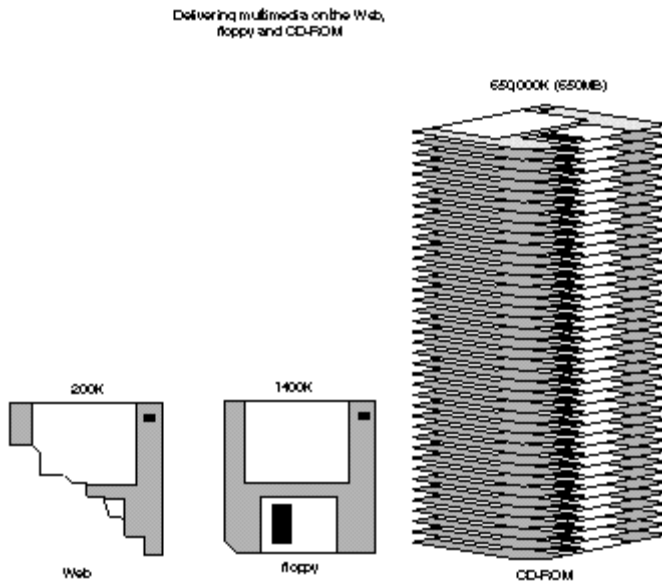

Figure 19.2
With over 600MB of space, CD-ROMs are ideal for multimedia.

Disk real-estate isn't the only physical constraint on your program; you have to consider the kind of system your end-users have. Chances are, their systems are much slower and less capable than yours. Graphic designers and artists have a hard time facing this painful truth. End-user machines are typically short on everything. RAM, computer speed, and color-depth must all be considered. Fortunately, the same tricks you use to deliver on disks or the Web also helps your program run faster and take less memory.

Media Creation

Media elements include still graphics, animation graphics, text, audio, and video. Depending on your skills and budget, you can get your media in one of three ways: make it yourself, reuse existing media (a corporate video, for

example), or buy from a stock (clip) photo, art, music, or video library. Getting the media elements is one step; the other is wrangling the media into the right format. This wrangling can sometimes take even longer than it takes to create the element in the first place, but authoring tools are finicky. For this reason, you really need the full suite of media editing applications even if you're not going to make any media elements yourself.

The big financial decision revolves around video. If you intend to use only pre-made QuickTime movies, you won't need any additional hardware or software. If you plan to edit digital video files—movies that have already been captured—you'll need plenty of storage space and at least 24MB of RAM for Adobe Premiere. But if you're going to do the initial capture (digitizing the movie from, say, a VCR into your computer), then you're hardware requirements ramp up sharply.

Integration and Programming

Most authoring tools function as a kind of media database and delegator. The authoring program is where you bring it all together and create the end-user's experience through navigation structure and interactivity. For a simple point-and-click slide show, authoring will be minimal compared to the effort of creating the media. For a sophisticated game or training program, however, the programming will be much more complex and time-consuming.

Although there are several easy-to-use multimedia presentation tools on the market, you need a high-end authoring tool to do commercial-quality work. The top contenders are Macromedia Director, Macromedia Authorware, and mFactory's mTropolis Professional.

Ratings

Macromedia Director	1	2	3	4	5
Ease of Use					
Great Features					
Coolness					
\$ Value					
Overall Rating					

Testing and Final Delivery

The 80-20 rule applies perfectly to multimedia development. At the integration and programming stage, 80 percent of your program will be built in the first 20 percent of your time. The other 80 percent of your time is spent on making the final connections, testing for bugs, fixing problems, and making sure it works on a range of playback machines. Testing and debugging are notoriously underbudgeted in most production schedules. Even seasoned developers tend to underestimate the time required. Under a phenomenon known as “developer amnesia,” multimedia producers just continue to be optimistic that each new production will be different. Unfortunately, each new production is usually more sophisticated than the last, as new technologies, new platforms, and new versions of tools are always pushing you into uncharted territory. You learn from the past, but what you learn becomes obsolete in a matter of months.

Creating Graphics

Preparing a graphic for multimedia is different from building an image for print. The key differences involve resolution (DPI), color depth, and file format. The good news is that you won't need a special image-editing tool just for multimedia: Adobe Photoshop is the perfect program for building multimedia graphics, but you also can use 3D tools, such as Macromedia's Extreme 3D or RayDream Designer.

Resolution: What You See Is All There Is

When you create graphics for print, what you see on the screen is just a representation. The screen is made up of a bunch of little cubby holes, each one holding a single dot—called a pixel—filled with a particular color. A single pixel is small, but still large enough to see on the screen. In print, however, a much greater number of dots can be packed into a given space. So whereas pictures for print might have a resolution of 300 dots per inch (DPI), the screen can only display 72 DPI. The bad news is that no matter what you do, you can't make your screen image look as crisp as your printed image. The upside is that graphic files in this lower resolution (referred to as “screen resolution”) are much faster and easier to work with.

Graphics artists, so familiar with the relationship between resolution and quality, have a tough time getting used to this one. But even if you save a graphic in a resolution higher than 72 DPI, that extra resolution is wasted. What you see is all there is. In fact, if you try to import a graphic into Director with a resolution higher than 72 DPI, you'll run into problems. It's still better to scan and edit at a higher resolution, because you can zoom in on pixels with more detail, but all graphics must be converted to 72 DPI before you import them into Director.

Image vs. Monitor Depth

There are really two different issues with color depth: pixel depth of the file, and pixel depth of the monitor. Any combination is possible. You could, for instance, have a 24-bit graphic but if your monitor is set to 8 bits (256 colors), you won't see all the colors. The computer instead displays a "dithered" image made up of only 256 colors. On the other hand, you could have your monitor set to display 24 bits (millions of colors), but an 8 bit image won't suddenly show a wider range of colors. Each pixel holds its color word—one of 256—and that's the color that is displayed.

In a typical multimedia program, both the image and monitor depths affect performance. Even if all of your graphics are saved in 8 bits, if your monitor (or your end-user's monitor) is set to display millions of colors, your program will still perform poorly. The opposite is also true: if the monitor is set to 8-bits, 16- or 24-bit images will strain the computer as it struggles to remap the colors in real time.

For best performance, both the images and the computer's monitor depth should be set to 256 colors (8 bits). To adjust your monitor, use the Monitors control panel. To adjust the color depth of an image, use Adobe Photoshop's Indexed Color dialog box.

Color Depth: Living With a Smaller Box of Crayons

Most multimedia is designed to play back on a typical 14-inch monitor. At 72 DPI, the average monitor has 640 pixels across and 480 down. This is the exact size you use when you create full-screen backgrounds for your program. If you multiply 640×480, you get 307,200 total pixels. Each pixel cubby hole holds information that tells the computer the color of the pixel. In the original Macintosh, this pixel held only one of two values: black or white. You also can think of it as on or off, 1 or 0, A or B. The computer's "binary" alphabet is stuck with just two characters. For now, we'll think of them as A and B.

Each bit in the computer equals one character in the computer's language. So a 1-bit display means that each pixel can hold only a single bit of information: A or B. That means each pixel can be either the "A" color or the "B" color. Today, however, most multimedia is built to be displayed with 8 bits per pixel. With an 8-bit display, each pixel can hold 8 bits of information. Each bit still holds A or B; we haven't added any new

characters to the alphabet. We now can have longer words. If you take all the possible combinations that can be made from A and B with eight slots, you come up with the familiar number 256.

The math for this, if you want to know, is simply 2^8 . The “2” refers to the number of possibilities for each bit (A or B), and the “8” represents the length of word (eight bits equals eight letters). With eight bits, you can have 256 different words in your vocabulary (AAAAAAB, BAAAAAB, and so on), as opposed to just the two in a 1-bit system. And each of these words represents—you guessed it—a color! So with 8 bits, you have 256 different words which means 256 different colors. Each pixel cubby hole can represent one of 256 possible colors.

A 16-bit system, then, can have words that are twice as long. With so many more combinations of A and B, each pixel can represent one of over 65,000 different colors. You can already guess what happens with a 24-bit system; with words that are 24 characters long, even a 2-character alphabet of A and B still gives you millions of different combinations. With 24-bits of information in each pixel cubby hole, you’ll never run out of colors.

There’s no doubt that for quality, the biggest box of crayons is best. If you only have 256 colors in your palette, subtle shading isn’t likely. Even a simple copper bowl, with highlighting and shadows, could use more than 256 different shades of copper. But there’s a huge problem with higher color depths in multimedia. In a multimedia program, the computer is already working as hard as it can to play sound, throw pictures on-screen, and move them around (for animation or video) as quickly as possible. An image composed of heavy 24-bit pixels is weighted down. It’s much more sluggish and difficult for the computer to move and even display. The fact of life today is that the average multimedia system still is not even capable of displaying millions of colors (24 bits).

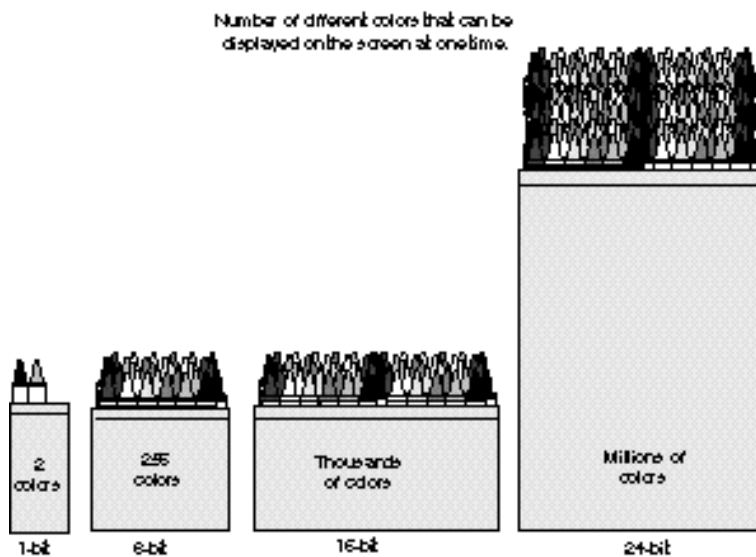

Figure 19.3

Multimedia graphics are usually 8-bit images, which means a palette of 256 colors. Images in higher bit-depths (with larger palettes) look better, but usually cause a multimedia program to run much more slowly.

The 16-bit images are substantially nicer than their 8-bit counterparts. Many people can't tell the difference between 16 and 24 bits. But because of the performance hit, 16-bit is still not recommended for most multimedia, unless the program is going to be played back in a controlled environment such as kiosk or presentation. Even then, assuming you have high-end hardware, performance may still suffer. This will change in the future, of course, but most multimedia today is still built to display at 8 bits.

How Graphics Get Their Size

A simple square-shaped graphic 100 pixels wide by 100 pixels tall contains 10,000 total pixels (100 × 100). For an 8-bit graphic, each of those 10,000 pixels holds 8 bits of information. 10,000 × 8 = 80,000 bits of information to represent that graphic. To get from bits to kilobytes (which we're more used to thinking about), we'll divide 80,000 bits by 8, which gives us 10,000 bytes, and then divide again by 1,000 (a thousand bytes are in each kilobyte). This leaves us with 10KB.

That same graphic saved as 24 bits would mean a graphic that's three times larger. For such a tiny graphic, the difference between 10KB and 30KB isn't much, but a full-screen multimedia background swells from 300KB at 8 bits to nearly a megabyte in 24 bits. The heavier a graphic, the more difficult it is for the computer to display it and move it.

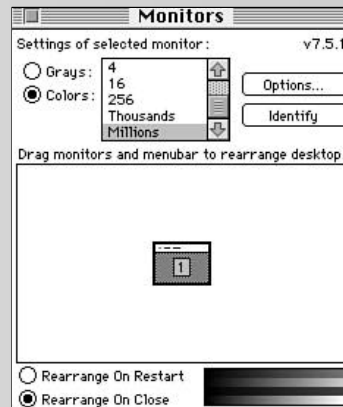

Figure 19.4

Set your monitor's bit-depth using the Monitors control panel. 256 is 8-bit, Thousands is 16-bit, and Millions is 24-bit.

Converting a Graphic to 8 Bits

There are two main ways to get an 8-bit graphic into your multimedia program. You can use Adobe Photoshop to save the graphic as an 8-bit PICT, or you can have Director convert the graphic to 8 bits when you import it.

One issue with 8-bit (256 colors) graphics is deciding which 256 colors are in that box of crayons (referred to as a color palette or color table). The easiest way is to use the Macintosh System Palette. The System Palette is a specific set of 256 colors that can represent just about anything reasonably well. The exception is flesh tones; a single face, in fact, could easily have more than 256 shades of flesh tones.

Although you can generate your own custom palette using either Photoshop or Debabelizer, it brings up a host of new problems and challenges once you begin authoring. The easiest and safest way to get 8-bit files into Director is to do the following:

- 1 In Adobe Photoshop, save your file as PICT. Choose 16 bits from the bit-depth dialog box that appears when you save as PICT.
- 2 Set your monitor to 8 bits (256 colors)
- 3 Open Director and import your PICT file. Director will recognize that the resolution is higher and ask if you want to have the image remapped into an 8-bit palette. You then can choose either the default Macintosh System Palette, another of the Director palettes, or any palette you have previously imported.

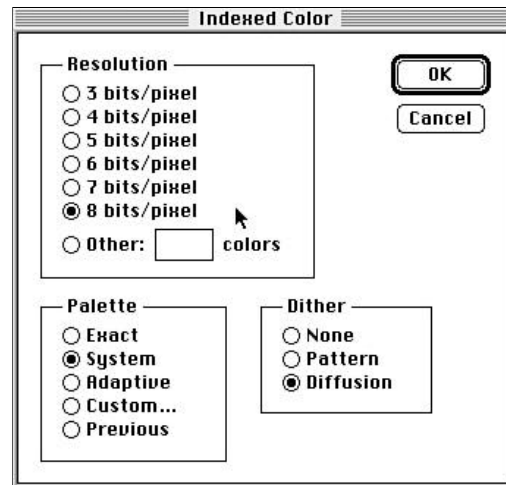

Figure 19.5

You can convert graphics to 8 bits by choosing Photoshop's Index mode.

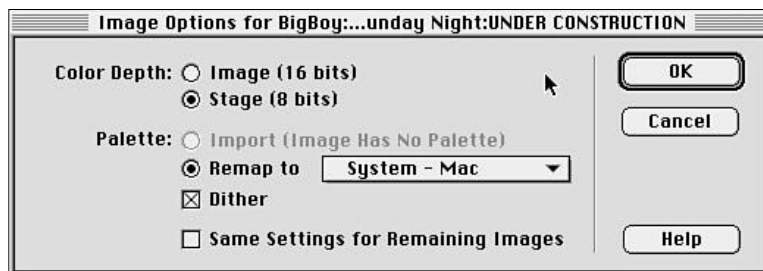

Figure 19.6

This dialog box appears if you import a graphic into Director with a bit-depth higher than the current monitor setting.

Creating Sounds

Audio is the most-neglected part of multimedia. Because so much multimedia is created by artists and graphic designers, it's easy to see why visuals (graphics, animation, and video) have drawn so much attention. But sound should not be the second-class citizen of new media. There are studies that suggest that audio has even more power over the end-user's perception of the quality of the program than do the images. In film school

101, students are always asked to view a classic dramatic scene, such as the shower in the original *Psycho* movie, without sound. Try it yourself: cue up your VCR to a movie scene that affects you emotionally, turn off the sound, and pay attention to your response (or rather, lack of).

Multimedia programs use audio as background music, event-triggered sound effects, ambient sound, narration and voice-over, and as a soundtrack to a QuickTime digital video file. Multimedia audio almost always is stored as a digital video file—basically a recording—that your program plays back at a particular time. Besides digital audio files, there are three other types of audio a multimedia program can use: MIDI, CD audio, and synthesized speech.

MIDI: Your Personal Orchestra

MIDI, which stands for Musical Instrument Digital Interface, is not really audio at all but a set of *instructions* for how to play back a particular piece of sound, usually music. It's kind of like sheet music. MIDI information says things like, "hit this particular note, at this particular time, and hold it for this long." But MIDI contains absolutely no information about the sound you actually hear. Like sheet music that might be played on anything from a grand piano to a child's xylophone, MIDI requires some sort of instrument to make the sounds.

The sounds that can respond to MIDI usually are stored in an external device, such as a MIDI keyboard or sound module. These boxes might contain, for example, 200 different types of instruments. When the MIDI-capable device receives a MIDI file, it uses its own sounds to play the MIDI instructions. So if the MIDI file says, "Play middle C on a guitar," the instrument does just that. How do you know the sound device has a guitar? In the past, you didn't. But with the relatively new General MIDI (GM) standard, you are guaranteed that each device or instrument adhering to the GM standard has the same 128 instruments.

If you, or the composer of the MIDI piece, stick to the instruments in the GM standard, you can be assured that your music will be played back on the correct instruments. That's pretty crucial when you think about it, because otherwise you couldn't be sure that your lovely flute piece wouldn't be played back as a Jimmy Hendrix guitar solo. With GM, however, you still can't guarantee the *quality* of an individual instrument. There are, for example, some sound modules containing only a grand piano sound which cost more than an entry-level 128-sound device. But that grand piano sounds much more realistic than the tinny, toy sound in the low-end sound module. Still, at least you know it's a piano and not the digeridoo that will play.

Although MIDI is used extensively in games made for IBM-compatible PCs, it's rarely used in games on the Macintosh. Musicians add MIDI devices to their Mac, but this is usually so that they can use Mac software for composing, sequencing, editing, and playing back their music.

What does this have to do with multimedia on the Mac? If you have a controlled presentation on a single machine (as opposed to a CD-ROM game that will be distributed), you could hook up a MIDI instrument and have your multimedia program send MIDI information to the device at certain points as the program is running. This is not a common practice, but it can give you CD-quality sound (like what you hear on your home stereo) as your presentation is playing.

One benefit of using MIDI instead of digital audio is MIDI's tiny file size. A three-minute song, for example, might take up 3MB as a digital audio file—at much less than CD-audio quality. The same song as a MIDI file, on the other hand, will be about 32KB. You could fit more than 90 different MIDI songs in the space of just one digital audio file! Also, those MIDI songs are played back by the sound device at perhaps twice the sound quality of your digital audio file. (You could have a higher-quality digital audio file, but it would take substantially more disk space and processing power to play back.)

In the early 90s, it looked as though MIDI sound modules might become a standard peripheral that every multimedia Mac would have. Yamaha and Roland both came out with relatively inexpensive GM-compatible sound boxes, but it never really took off.

But something wonderful did happen: Apple added MIDI-compatible musical instruments to QuickTime. These musical instruments are not in a hardware device, but live as software in your System Folder. To take advantage of this within a multimedia program, you have to turn your MIDI file into a QuickTime musical instruments file using Apple's MoviePlayer software. The QuickTime movie then acts as a sound-only file that you can import and play within your multimedia program.

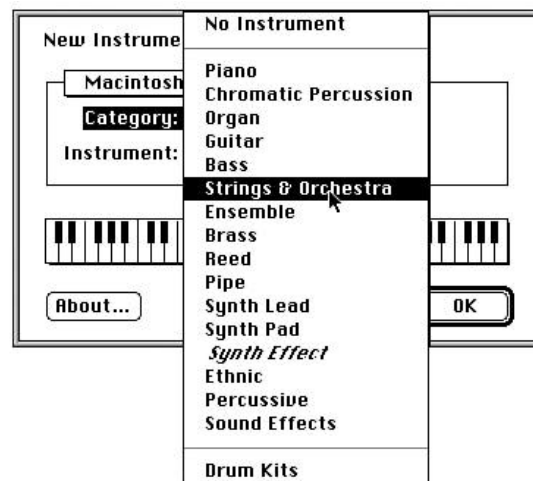

Figure 19.7
Using Apple's MoviePlayer 2.0, you can change any instrument in a QuickTime MIDI-compatible music track. Each of the 16 instrument categories includes eight choices, for a total of 128 different instruments.

Keep in mind that the current state of these software-instruments is limited. They don't sound nearly as good as the sound produced by an external MIDI device, but you do get the huge space savings. If disk space is not a problem with your project, then regular digital audio probably makes more sense. But if you have to deliver on a diskette, or over the Internet, then the difference between 32KB and 32,000KB is everything!

MIDI files can be created using a sequencing program, such as Opcode's EZVision. You still need a piano-like MIDI keyboard or other MIDI-compatible instrument if you intend to compose the music yourself. You don't, however, have to be a musician to use MIDI. There are plenty of royalty-free clip MIDI files available in addition to software programs that enable you to do some basic rearranging of pre-existing MIDI parts.

CD Audio

CD audio refers to the same format used by the CDs you play in your car or home stereo. The information is stored digitally, just like your own digital audio files on your Mac, but it's in a different format and is played back differently. In fact, the computer doesn't have to do much processing at all to play back CD audio—it simply tells it where to start and stop. Director provides a method for triggering audio CD from within your multimedia program.

CD-ROMs about music are an obvious example of when it might be useful, but anytime you want the highest-quality sound (and, as with MIDI, you don't have the storage space) you can use audio CD. One potential drawback, however, is that the CD drive can't be in two places at once. So if you have, for example, a multimedia program displaying animation, QuickTime movies, or large graphics, the program flow is interrupted if the CD has to go to some other place on the CD-ROM to read the musical information.

Synthesized Speech

In the early days of the Macintosh, the Macintalk speech synthesizer could read text aloud in a robotic voice, but unless you had the text to read what it was speaking, it was almost impossible to understand. After a long gap wherein Apple didn't even support Macintalk, a greatly improved speech engine was released as Macintalk Pro.

As with CD audio and MIDI, the use of synthesized speech can cut down dramatically on file sizes. Text, which is what Macintalk Pro reads, is much, much smaller than digital audio. Still, it can only represent spoken words, not sound effects or music,

I think it was John Coltrane who said that true improvisation can occur only after having mastered one's instrument. That is, until I understand the rules of design—either implicitly like David Carson or explicitly like Massimo Vignelli—I cannot improvise, only make noise.

Joe Shoemaker
On-Line Services Creative
Director
Indianapolis Newspapers,
Inc.

so it can only substitute for narration. And because it still doesn't sound quite human, you certainly wouldn't use it in applications where it was important that the end-user hear from an actual person.

In many games, training applications, and even reference materials, synthesized speech can have an advantage that goes well beyond a reduced file size. Because synthesized speech is spoken from text, and text can be generated as a program is running, your program could say things that you couldn't have known in advance. If, for example, the user enters his or her name and you simply want the program to say, "Hello Kelly" (or Sue, John, Reggie, and so on), how would you do this with digital audio? Actually, there are some games which do this, but they have to pre-record hundreds of names in advance, and then compare what the user types to the list of pre-recorded audio files, and then play the appropriate one. With today's practice of giving children less-common (or, at least, less commonly-spelled) names, the chances of finding every child's name isn't promising.

With Macintalk Pro, your program could speak all sorts of things you couldn't know in advance, such as game scores, other information the user has typed, calculations, and so on. Of course, it might not be significant to your program that text on-screen be spoken out loud, but multimedia experts agree that every additional sensory experience deepens the user's involvement. If the user can see and hear the information, they may be more likely to retain and respond to that same information later.

Although Director does not support Macintalk Pro directly, several third-party extensions enable you to use speech synthesis in your program. Most other high-end authoring tools, as well, have some mechanism for using Macintalk Pro. The big downside to speech synthesis, however, is that it is not cross-platform. Although QuickTime, including musical instruments, can run under Windows, Macintalk Pro does not. There might, however, be good news soon. At the time this book went to press, at least two third-party developers were working out ways to enable Director authors to use synthesized speech in a cross-platform title. The strategy for this would use Macintalk Pro when playing on a Macintosh, and some other proprietary speech synthesizer when playing on a PC. Whether you'll be able to distribute the PC speech synthesizer free with your titles had still not been determined.

Digital Audio: The Ultimate Tape Recorder

Despite many of the advantages of using MIDI, CD audio, or synthesized speech, the disadvantages make each of these the least likely choice for audio in most multimedia today. By far, the type of audio you hear, and will use, in a multimedia program is pre-recorded digital audio files. Just as photographs can be scanned into the computer, converting them into the ones and zeroes the computer understands, any type of audio can be recorded into the computer.

The process for converting sounds from what you hear—which is called *analog*—into a digital computer file is called *digitizing*. The digitizing uses what’s called, appropriately enough, an *analog-to-digital converter*. The easiest way to digitize sound is to simply speak into your Mac’s microphone (mic). Although not every Mac has a built-in mic, they all have a mic port on the back, usually right next to the speaker port. These ports don’t accept just any microphone; you must use a mic created specifically by Apple for your type of Mac, or follow Apple’s recommended technical guidelines for connecting a non-Apple external mic.

You also can connect an audio cable directly from your stereo, DAT tape player, camcorder, or external CD-ROM drive directly into the mic port or through a special adapter. If you have an internal CD-ROM drive, you can record directly from a regular audio CD into the Mac without cables.

You need software, of course, to manage the recording and to save the file. Macromedia’s SoundEdit 16 is the mid-level tool most commonly used by multimedia producers. Sound design professionals often use other far more expensive programs, but SoundEdit 16 is an excellent tool for recording, editing, and processing sound for most multimedia.

Ratings

Macromedia SoundEdit 16	1	2	3	4	5
Ease of Use					
Great Features					
Coolness					
\$ Value					
Overall Rating					

The most important thing to know about sound is that sound files can be huge. Massive. And the higher the quality, the larger the file size. File size also has implications beyond just disk real-estate. Assuming you have all the space in the world to store your multimedia assets, the computer your program plays back on still has to deal with it at runtime. And if the computer is playing a data-heavy sound file, it won’t have enough energy left to do other things at the same time, such as display animation, large graphics, or process a lot of user input.

The two factors that affect the quality (and thus file size) of a digital audio file are bit-depth and sampling rate. You don’t have to be a sound engineer to use audio in a multimedia program, but you do need to understand the tradeoffs between differences in bit-depth and sampling rate. To understand this, we’ll look at exactly what happens when you record—digitize—sound into the computer.

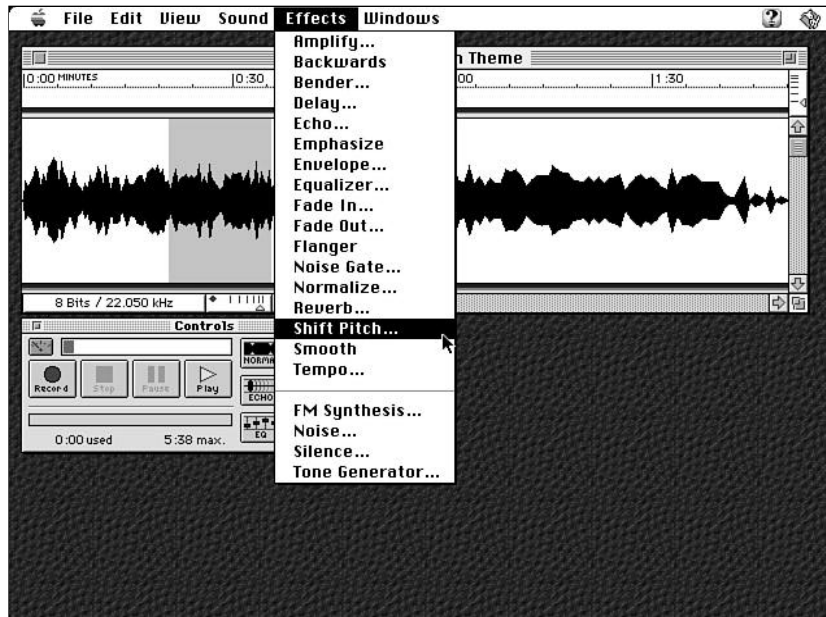

Figure 19.8

With Macromedia's SoundEdit 16, you can record, edit, and apply special effects to music and sounds.

Sound that you hear is continuous, but in the computer's world, everything has to be represented as discrete ones and zeroes. So to capture sound into the computer, the analog-to-digital converter must grab snapshots of the sound at different points in time. These digital snapshots are represented by ones and zeroes in a way the computer can deal with. When it's time to play the sound back, the computer fills in the spaces between the snapshots with its best guess as to the sound (pitch, tone, and so on) that was originally there. It does this as it sends the sound through a reverse-digitizing processor—the *digital-to-analog* converter. The digital-to-analog converter is the thing that pumps sound out to the speakers so that your ears can hear it as continuous music.

It should be obvious, then, that the more frequently the digital snapshots are taken, the more faithful the digitized sound is to the original. With less unknown information in between snapshots, the computer won't have to do as much guessing.

The frequency of these digital snapshots is referred to as sampling rate, for the *rate* at which digital *samples* are taken. With CD-quality audio—the sound you hear from your home stereo—digital samples occur at a rate of approximately 44,000 every second! This seems like a lot, and indeed this sampling rate (referred to as 44 kilohertz or 44 KHz) captures frequencies well beyond the range of human hearing. Although there are still some audiophiles who argue over what's lost in the digitizing process, most agree that 44 KHz is as good as it gets. Regardless of the sampling rate you use for sounds in your final multimedia program, you should first digitize your audio at the highest rate you can get, ideally 44 KHz. (Technically, it's 44.1 KHz.)

The second part of the digital sound equation is bit-depth. When you take your digital sample, your snapshot, the computer stores digital information that represents the sound. Basically, the more information describing each snapshot, the better. Because information is stored as bits (which can be either ones or zeroes), the more bits you use to describe a snapshot of sound, the better chance you have of reconstructing (during playback) the original sound. CD-quality audio stores 16 bits of information with each sample. In other words, there are 16 different slots holding ones and zeroes (or, from our graphics example, A's and B's). This gives a much more accurate representation of the sound's dynamic range than with the more limited 8-bit depth most multimedia sound uses.

The harsh reality is that most multimedia sound is, and needs to be, made of 8-bit samples at a rate of just over 22,000 per second. This is often just called 8/22 sound, from 8 bits at 22 KHz. As you can see, this is half the quality, in both bit-depth and sampling rate, of CD-quality audio. Can you tell the difference? Absolutely. But you already know this. If you've ever played a CD-ROM program and noticed that it didn't sound as good as your audio CDs, then you're probably experiencing 8/22 sound, and possibly even 8/11.

Although all new Macs are capable of 16/44 sound, even the most powerful Macs still strain under the weight of processing so much information in a multimedia program. SoundEdit 16 will play back your 16/44 sounds without flinching, but put the same sound inside Director and ask it to play along with an animation, and things start to choke. Also, with such large file sizes, even a 650MB CD-ROM can start to seem cramped. And the Internet? 8/22 is a luxury you can't afford when delivering over the Web. You have to either keep your sound files extremely short, or reduce your bit-depth and sampling rate even further.

Ratings

Adobe Premiere	1	2	3	4	5
Ease of Use					
Great Features					
Coolness					
\$ Value					
Overall Rating					

The best rule of thumb is: digitize, edit, and process your sounds at 16/44, and then at the last moment convert them to 8/22. Fortunately, there are a few tools that can help you get the most out of 8/22 sound. The L1 filter from Waves Technology, which can work with several audio programs and even Adobe Premiere, is designed to convert your digital audio file in the most optimal way.

Tips for Good 8/22 Sound with SoundEdit 16

The best way to get good 8/22 audio is to have a professional sound designer—one who specializes in multimedia—process it for you. They have tricks and recipes as long as this chapter, which usually require several different programs to accomplish. The second-best way is to use the L1 filter, which is what most of the pros use anyway. The third way is to apply some of the concepts used by the pros, within SoundEdit 16.

- 1 Start with the best possible source. Yes, this is ridiculously obvious. Nobody thinks using the scratchiest version is a good idea, but sometimes it takes effort to track down the original, or at least a version that isn't more than a generation or two away. This goes for soundtracks in videotape as well. If, for example, a client gives you a corporate video, ask if there is a DAT of the final sound mix. You can then capture this sound independently from the video, process it, and edit it back into the digital video file.
- 2 Always capture at 16/44, no matter what your final sampling rate and bit depth will be.
- 3 Digitize the "hottest" possible signal. This means adjusting the input level so the waveform just about fills the entire sound window of your sound editing program. The closer to a flat line the waveform is, the worse it will sound when it's converted to 8 bits.
- 4 Select the entire waveform and apply the Normalize filter. This will boost the entire waveform as far as it can go without distorting (called "clipping"). If the Normalize filter doesn't seem to do anything, yet the waveform still fills less than half the window, then it means there is already at least one spike in the waveform that's hitting the edge. In that case, scroll through the file to find the spike (or spikes) and use the Envelope filter to reduce the spike by 20 percent. Try the Normalize filter again.
- 5 Copy the entire waveform and paste it into a new sound file formatted as 8/22.

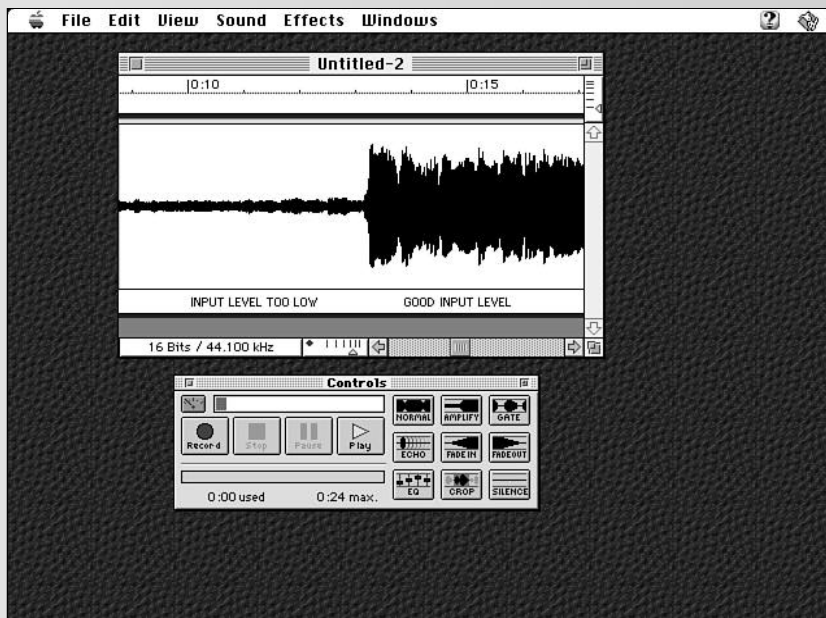

Figure 19.9

Sounds should be recorded at the highest acceptable input level; the waveform should nearly fill the sound window.

The final consideration for your digital audio is file format. Most multimedia authoring tools accept the AIFF format, which SoundEdit 16 supports. If you author in Director, AIFF files can be played back on both Mac and Windows.

Using Video

Of all the media elements, digital video is the new kid on the block. And if we thought audio files took up a lot of space...digital video is unimaginably big. Without extreme file compression, it would be impossible not only to store digital video, but also to play it back.

As far as the computer is concerned, the visual part of video is nothing but a series of still pictures, running at a rate of 30 pictures (frames) per second. Each frame is equivalent to a full-screen bit-map—640×480 pixels, 24-bit color, at 72 DPI. But if you remember from the earlier section on graphics, a single full-screen, 24-bit image takes up nearly 1MB of space. At 30 frames per second, just a single second of video would be a 30MB file! Uncompressed, a full-screen digitized video file of a 60-second TV commercial would be 30MB×60, or 1,800MB! That's just about two gigabytes—more than most people have in their systems, just for a single minute of video. If hard disk prices suddenly dropped to a penny a megabyte and you could have all the space you needed, the computer still couldn't possibly cope with blasting all the pictures to the screen at 30 frames per second. The biggest Power Mac on the planet would be gasping after the first few frames.

The only solution is to find ways to make the video file smaller. The first technique is to reduce the size of the video image. Digitizing videos at quarter-screen size (320×240) reduces our 60-second video from 1800MB to 450MB—a huge drop, but we're still not even in the ballpark for playability. The second way to reduce size is to drop frames. Dropping from 30 frames per second to 15 cuts out half of the pictures, which puts the file at 225MB. Still, it's too big to play until some of the most intense math and computer programming in the world cranks through the video file and figures out how to represent it in a kind of shorthand.

This shorthand compresses the video file into a fraction of its uncompressed size. As the video plays back, the frames are unpacked—decompressed—as needed, then immediately packed away again.

Ratings

Videoshop	1	2	3	4	5
Ease of Use	████████████████████				
Great Features	████████████████				
Coolness	████████████████████				
\$ Value	████████████████				
Overall Rating	████████████████				

How QuickTime Movies Stay in Sync

Software runs differently on different Macs. Obviously, a faster and more powerful Mac can display windows and do calculations quicker than an older or less capable one, but with video, you need to guarantee that it always runs at the same rate. You wouldn't want it to run chipmunk-fast on a 9500 Power Mac and in slow-motion on something less.

So, assuming that a video's soundtrack has to run at a fixed rate, QuickTime's job is to somehow keep the video frames in sync. It manages this by dropping video frames. If, for example, a video has 30 frames each second, a QuickTime movie running on a machine that can't keep up might skip every other frame, thus running at 15 frames each second. Technically, the speed is always equivalent to 30 frames per second (the standard rate for digital video formats), it's just that QuickTime won't necessarily be able to display 30 *different* frames each second. Instead, QuickTime holds a single frame for what might be the time it would normally be displaying two, three, or more frames.

A video playing back at 15 frames each second will play frame one, then frame one again, then frame three, and three again, and so on. The less powerful the Mac, the more jerky the video appears, because you won't be able to see all of the inbetween motions. This dropped-frame effect is why some "talking head" videos can appear badly lip-synched, even when the sound starts and ends on the correct frames. Skip two frames, for example, and you might miss the mouth movement for a syllable. You still hear it; you just don't see the lips move!

The more frames displayed per second, the smoother the video appears, but high frame rate is always a tradeoff for something else. Assuming that a given Mac (especially from a CD-ROM) can only manage a specific amount of total information per second, you must usually choose between frame size, frame rate, and frame quality. If the quality of an individual frame is extremely important, for example, then you'll probably have to keep the dimensions of your QuickTime movie small and the frame rate less than 30 different frames each second.

Video Compression

Video compression can be either hardware- or software-based. Apple's QuickTime includes several different types of software compressors; the most popular for CD-ROM playback is Cinepak. Hardware compressors are found in some video capture boards such as the Radius VideoVision. They offer powerful compression and decompression, faster and with higher-quality than is possible using software-only compression. The downside of hardware compression is that the digital video files can only be played back on machines with the same hardware. So you won't, for example, use hardware compression for a CD-ROM game, but you could use it for a kiosk or a presentation where you would purchase special equipment.

Hardware compression is especially important when you're first capturing a video file, because it's fast enough to keep up with a video as it's being digitized. Software compression, on the other hand, is usually way too slow to keep up with all that video information pouring in. If you don't use a

video capture board with hardware compression, the quality of your digitized video won't be as good, and you won't be able to grab as many frames.

For this reason, most developers either use a hardware compression board for capturing video, or they send the video to a service bureau for the initial capture. After the video is captured, it can be edited by converting it into another compression scheme or, in the case of Radius VideoVision, by using special software that emulates the VideoVision hardware compressor. The VideoVision emulator software won't play your video back very well, but it does enable you to continue editing and working a VideoVision-captured and compressed movie from another computer without the extra hardware.

Video compressors use two main strategies: spatial and temporal compression. Understanding just a little about how the compressors do their job can help you take advantage of them. First, you need to recognize one thing—most compression takes a terrible toll on video quality. Anything you can do to make the compressor's job easier will be repaid with better-looking video.

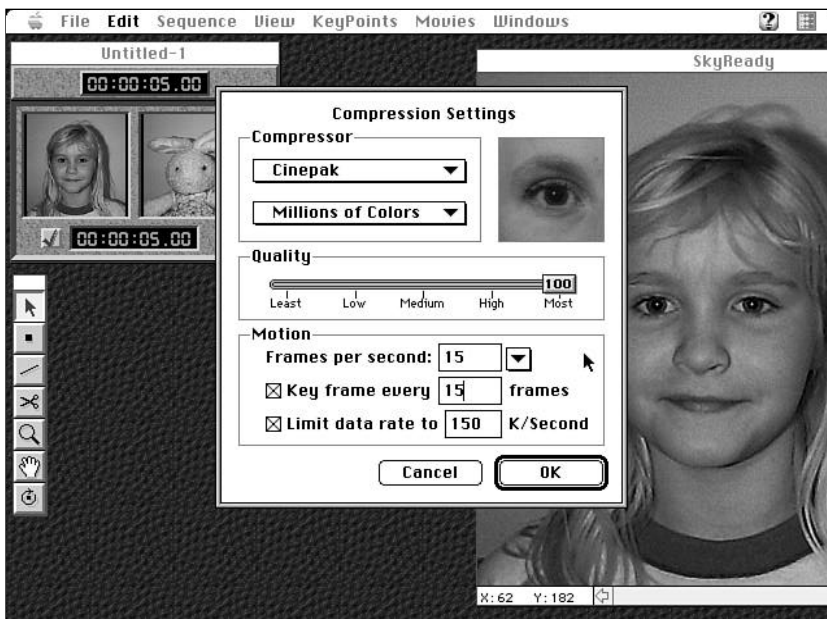

Figure 19.10

When exporting a video or animation as a QuickTime movie, you get a standard dialog box for choosing compression settings and frame rate.

Spatial Compression

Spatial compression treats each individual frame of video as a still graphic (exactly as though you had scanned a photograph) and reduces the number of bits it takes to represent that image. Although the formulas are quite complex, it's based largely on how frequently pixel colors change. If, for example, the top row of pixels in a single frame were *all* the same color blue (imagine a deep blue, cloudless sky), a compressor could represent this as a simple formula, such as SKYBLUE400, instead of having 400 different pixels worth of color information. QuickTime doesn't need the 399 redundant descriptions of the color blue.

You can imagine the kind of image that would compress best—a solid block of color! On the other hand, you can imagine a frame image that could bring a compressor to its knees: a frame where every other pixel changes color. Unfortunately, the inherent noise in most video, especially lower-quality video, makes big solid blocks unlikely, even where colors are *supposed* to be the same. If you crank up the compressor to its highest settings (which means smaller file size), then the compressor becomes less picky about what constitutes a similar color. Thus, if that blue sky was full of different shades, the compressor would just pick an average blue and say, “Oh, that's close enough,” and represent the whole sky as SKYBLUE400.

The tradeoff with this less-picky compression is quality. When the compressor decides that all those blues could be considered a single color, the original differences are lost. Thus, when the video is decompressed—played back—you won't see the original sky, but instead the solid color of blue that the compressor stored. This loss of detail might not matter in some images, but for some frames, the fuzzy, muddy look just won't work.

The best way to get higher-quality QuickTime movies is to give the compressor something it likes: large blocks of solid colors. This way you still can get the smaller file size you need, without having to lose a lot of detail. Computer-generated animation compresses the best, because they don't have all the random video noise from actual video. But carefully-shot video can be optimized for final delivery as QuickTime, and it can make a drastic difference in quality.

Temporal Compression

Although the spatial compressor doesn't know that the picture being compressed is a frame of video, temporal compression only works *because* the frames *are* changing. The spatial compressor represents, in its shorthand color formulas, a single frame, but even if two consecutive frames are identical, it still goes through the process on the duplicate frame, and stores the new (although identical) formula. Temporal compression, however, looks through the video file and takes note of differences between frames.

The temporal compressor, then, has a type of shorthand that is kind of like saying, “Use the spatial compressor’s info from frame one, and duplicate it for the next 30 frames, except for these differences...” A 30-second clip, for example, with a small squirrel running across the bottom of the scene would only need to store the information about the top part of the screen once. The only new information comes from the bottom areas of the screen where the squirrel is moving.

You can imagine the worst kind of video, if you’re trying to take advantage of temporal compression: the jerky, handheld “camcorder” look. If the camera is moving, every pixel in every frame is changing, and the temporal compression has nothing to work with. The ideal video (but good luck getting your videographer to agree) is one with no panning or zooming, and is shot from a tripod with no camera or image movement whatsoever.

Tips for Better QuickTime Movies

The best scenario for good QuickTime movies begins with shooting the video. If you have any control over the original video shoot, the following guidelines will produce better compressed digital video:

- Use a tripod.
- Don’t pan or zoom. Keep the focus still.
- Use excellent lighting.
- Use a solid color background.
- Avoid patterns in clothing or wallpaper. Use solids.
- Shoot with Hi-8, SVHS, or better.

When capturing and editing video:

- Capture to the highest quality video board.
- Adjust input levels before capturing.
- Digitize at the highest possible frame rate.
- Never compress more than once with a lossy compressor, such as CinePak.
- Balance the tradeoff between frame size, frame rate, and frame quality.

Ratings

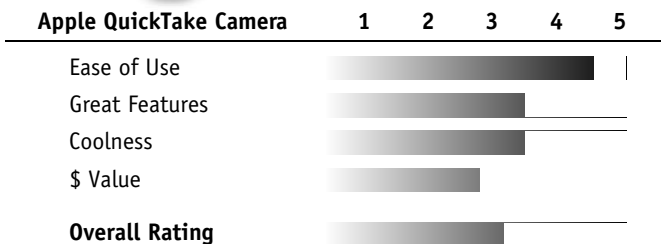

Creating Animation

Animation is just graphics that move. This happens in one of two ways: move a single still image on-screen or cycle quickly between different images. Animation can be played back by saving it in a QuickTime movie format, or by authoring tools, such as Director or mTropolis, by giving the program instructions for how to move—or switch—the graphics.

To build an animation you can use a paint program, such as Adobe Photoshop or Fractal Design's Painter, or you can create it in a 3D tool, such as Macromedia's Extreme 3D. 3D programs that offer animation capabilities usually let you export the file as either a QuickTime movie or a series of still PICT files, which then can be imported into Director.

Keep in mind that full-screen animation is going to be just as difficult to play back—if not more so—than full-screen digital video, regardless of whether they are saved as QuickTime movies or not. So, after you have built that spectacular 3D flying logo, don't expect it to play back unless you reduce the size. The best way to get good performance from an animation is to reduce the part of the image that is actually moving.

Integration: Putting it Together

The most exciting part of authoring happens when the design and the media come together as you build the end-user's interactive experience. Using an authoring tool, such as Director, you import your media elements, arrange the screens, order the sounds, structure the navigation, and script the flow and interactivity.

The first phase is simply importing all the media elements. Director is happiest with PICTs, QuickTime, AIFF sound files, and RTF text. You have two choices when you import a file: linked or unlinked. Unlinked, which is the default, brings an actual copy of the original file into Director. You could throw away the original file you're importing and it would have no effect on your Director program. Importing as linked doesn't bring a copy of the media element into Director, although you won't initially be able to tell the difference. Linked files *appear* to be inside Director—you can see them and work with them within the program—but Director is really using the actual, original file on the disk. Rather than importing a copy of the file, Director instead brings in the instructions for how to find the original file. In other words, it imports the pathname to the file.

NOTE

Director includes a Cast window for organizing media elements, a Score for orchestrating program timing, a Stage for screen layout, a Paint editor for creating and modifying graphics, and a programming language for scripting program behavior.

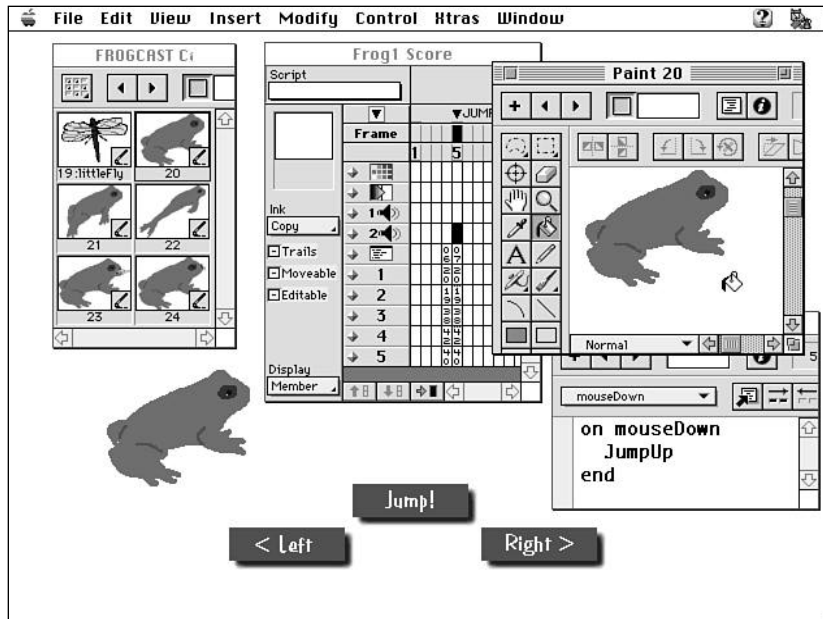

Figure 19.11
Macromedia's Director is the most popular high-end authoring tool.

The advantage of using unlinked files is that your entire program is self-contained. You can move and deliver your multimedia file without tracking and moving all the media elements too. Unlinked files are generally more responsive. Director converts them and compresses them into its own Director format, optimized for portability and playback. Finally, unlinked files are cross-platform; the same Director file can be played on Windows or Macintosh, even if the original files were not cross-platform.

Of course, you can end up with a single multimedia file that balloons to hundreds of megabytes in size. That can be quite a burden when you're trying to save and move that huge file around. Using linked files, however, you can keep multiple copies of the media files on different machines, and then you only have to move and save the small "engine" file. As long as the same media elements, with the same names, are on the other machines (and in the same file folder level relative to the Director file) everything will work.

The best part about using linked files, is that you can edit and change the original file, and the Director multimedia program is automatically updated. Since Director only points to the original linked file, the most current version of the media element is always what's used by Director. With unlinked files, however, any media changes must be reimported back into Director.

Many multimedia developers use a strategy of keeping files linked while production is still underway—so changes can be made more easily—and then converting the media elements to fully imported, unlinked near the end of production. The exception to all this is QuickTime movies. QuickTime movies are *never* actually imported into Director; they are

always kept as separate files, external to the Director multimedia file. So, anytime you move a Director file that contains QuickTime movies, you must be sure also to move the QuickTime files along with it, or they won't be there when Director tries to play them back.

Special Deliveries: CD-ROM, Disk, Web

The biggest tradeoff decisions you'll ever have to make in multimedia revolve around the media on which you deliver your program. Specifically, how much room you have for your program and all of its media elements. A CD-ROM, for instance, can hold more than 600MB. That would give you enough room for about 2,000 full-screen (640×480), 8-bit graphics. Switch that to a diskette, however, and you can knock off about 1,999 of those graphics. That's right, you can expect to have room for only a single full-screen graphic if you're going to ship your program (including a run-time player) on a disk. What about delivery on the Web? Forget the whole idea of full-screen graphics; you should be concentrating on tiny images and minuscule sound loops.

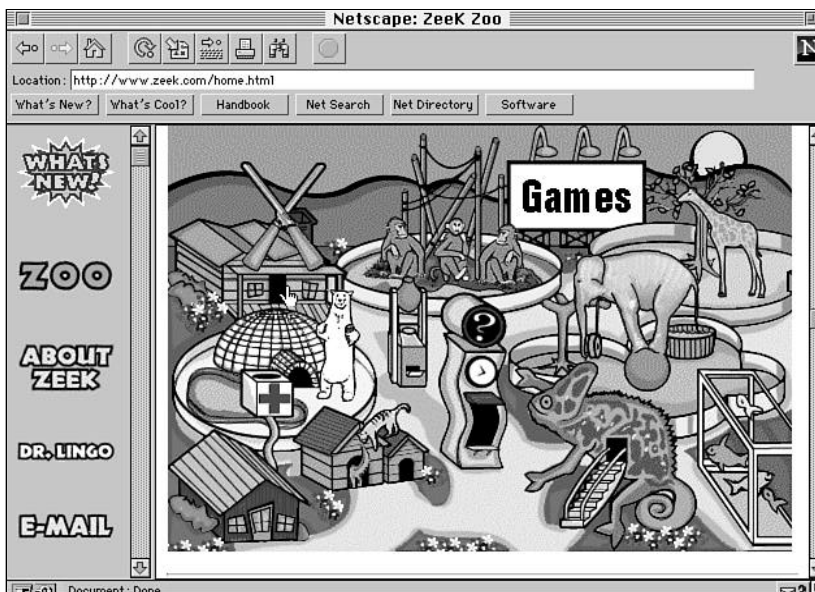

Figure 19.12
Multimedia programs built in Director can be played over the Web using Macromedia's Shockwave plug-in, but graphics and sounds must be kept as small as possible.

There's truly an art and skill to designing and delivering under such tight constraints as a diskette or the Web, but there are a few tips and tricks that can help. For delivering Director files in the least amount of space:

- Lower the bit-depth on graphics whenever possible; in Director, you can convert any one- or two-color graphic to 1-bit, and colorize it using the Tools palette.
- Use small sound loops that loop continuously rather than long sound files.

- Trim all graphics to their absolute smallest size using the eraser or selection tools in the Paint window.
- Animate only a small portion of a graphic; that way you only have to store (as a new graphic) the part of the image that moves.
- Use Director's shape tools rather than bitmaps whenever possible.
- Colorize the Stage in Director rather than using a full-screen background.

CD-ROM delivery, although with plenty disk real-estate, is burdened with a different problem: speed. Or rather, a lack of. Even the latest high-speed CD-ROM drives can be hundreds of times slower than your hard disk. They are slow in two areas: seek time and data transfer. When you have 600MB of stuff on the CD, the drive has to physically move to the right location to retrieve, say, a particular sound file. If that sound happens to be lying on the CD at the opposite end from where the graphic you just asked it to display, there is a delay. That's seek time, as the drive seeks out the data. But after it gets there, it can only pull so much information into the computer at a time, regardless of how much RAM you have. Things on a CD read-in at a much slower rate than from the hard drive. That's called data rate, and is expressed in kilobytes per second.

Just being aware of the speed limits should help you design programs that can take better advantage of CD-ROM delivery. Games that require fast action, for example, must be kept in small enough segments that they can be loaded into the user's RAM. In RAM, things move very quickly, but when you have to go back out to the CD, that's when, for example, the alien freezes in mid-air waiting for the explosion sound to be retrieved and loaded.

To help design around CD-ROM limits, you should build your program in small segments, with natural pauses. You also must keep your QuickTime movies to a rate of under 200KB per second (you set this within Adobe Premiere during final compression), or even less for Windows delivery. You also, to minimize seek time, should have your media placed on the CD in the approximate order in which it is likely to be retrieved while the program is running. Finally, when speed is important, keep the images small. You might have a ton of room for big graphics, but you simply won't be able to grab them from the CD and throw them to the screen very quickly.

Delivering on That *Other* Platform

One of the nicest things about multimedia is that you can develop it on a Mac, and play it back under Windows. It's not painless, but thanks to Macromedia's Director, it can be accomplished. The most important point to remember is this: you must test your program on a Windows machine as you build it. If you wait until the end, it might work fine, but then again it might crash horribly in multiple and hard-to-track ways. You don't have to check every graphic and sound file (just a few test cases to be sure you're happy with the palettes, and so on). After you start assembling and programming, however, you should plan on cross-platform tests at least once a week.

Some developers simply rent a Windows machine during that time. Others send their program out to a Windows testing service bureau. You shouldn't do this until you've already tested it yourself. A testing bureau is good when you want to make sure it runs on a lot of differently-configured Windows machines. This should be done after you've verified that the file is basically Windows-compatible.

The idea of using Windows emulation software on your Mac, such as SoftWindows, is good in theory, but in practice, it doesn't provide the realistic test you need. You have to see how your program reacts on a *real* Windows machine, using typical display device drivers and all the other stuff from which Mac users are usually protected. The worst scenario, and one that developers make every day, is to build your entire program on a Mac and then try to "convert" it to Windows after it's done. You could get lucky, of course, but don't count on it.

Tips for Windows delivery include:

- Use the Windows-compatible filenames (eight characters with a three-character extension).
- If you keep your files linked, use PICT and AIFF as file formats.
- Don't expect to play both QuickTime with sound and digital audio at the same time. Force your digital audio to stop before playing the QuickTime movie, otherwise, you might not hear the soundtrack in your movie.
- Reduce the data rate of your QuickTime movies to 150KB per second or even less.
- Path names are separated by a backslash instead of a colon on Windows. You have to adjust any programming that refers to exact pathnames.
- There are, unfortunately, dozens or even hundreds of little things that either don't work the same, don't work right, or don't work at all under Windows. Many are undocumented, which is why you must test, test, test.
- Use available resources! Others have already blazed the trail and are willing to share their experiences. Macromedia's Web site at <http://www.macromedia.com> points you to technical notes, user groups, Internet newsgroups and mailing lists, books, training materials, and other Web sites.

Summation

In the future, all of these constraints will begin to drop away. We'll have faster access to the Internet, CD-ROMs will be replaced, perhaps by the faster and larger Digital Video Disc (DVD), and we'll exchange 1 gigabyte diskettes. The computer processors will have sped up as well. You can move graphics around pretty quickly with a lot of RAM and 200 megahertz under your Mac's hood. Just as we used postage-stamp sized QuickTime movies a few years ago and now are working on half-screen movies, we'll inevitably all be using full-screen, full-motion videos soon.

Of course, that's just about the time we figure out the technology for some entirely new media element. If you thought QuickTime files were large... wait until you get a whiff of digital chocolate. The multimedia future smells very promising.

Business Applications

It would be nice if all you had to do to run a business was to “do” whatever it is that your business is about. Unfortunately, you need to spend a good part of your time “doing” the business. You need to find clients for your product or service. You need to send out bills for the work you do and keep track of who has paid and who hasn’t. You need to pay suppliers, and possibly you need to pay rent and utilities. Inevitably, you’ll need to pay taxes. You might even have an employee or two who expect to be paid. If your business is big enough to hire a bookkeeper and secretary, skip this chapter. If, like most of us who freelance, you’re the CEO, receptionist, and everything in between, read on.

If you want to know... Go to...

What is the best word processor for my needs?	477
How can I convert documents for publication on the Web?	479
How can I bank my modem?	498
What is a good accounting program?	492
What are the advantages of a fax/modem?	489
How do I print envelopes?	483
How do I create a mailing list?	484
Are Organizer programs worth the trouble?	500
How can I track the hours I work?	494
Do Works programs work?	487

Business Basics

There are really only a few things that you need to get up and running. One is a word processor. Sure, your DTP program can handle text, but for ease of use, especially for jobs such as sending out a personalized mailing to several hundred potential clients, you can't beat the combination of a database and a good word processor. Database? Don't panic. The term sounds a lot more technical than address book, but that's essentially what it is. Databases keep track of addresses, phone numbers, and any other information you want to keep handy. Client hates the color green? Make a note of it. The address book function can be combined with a calendar in programs called Personal Information Managers, or PIMs. If an ordinary database is similar to a dime-store address book, then a PIM is more like one of those leather-covered, inch-thick DayTimer books. It keeps track of deadlines, appointments, addresses, phone numbers, and any other information you want to put into it.

You probably have a fax machine. If not, a fax/modem with fax software is a necessity. It's a help even if you do have a standalone fax machine. The faxes you send directly from the computer look better than the ones sent from the fax machine. There's no generation loss. It's similar to the difference between a laser printed page and one that's a photocopy of a photocopy. You also can use the fax machine as a "quick and dirty" scanner, sending the faxed image to your Mac. Perhaps even more important, the modem gives you access to the Internet, as well as to commercial online services and to other useful services, such as banking, shopping, shipping, and package tracking.

Finally, you need an accounting program. There are all kinds, but if you're a one-person business, all you really need is one that can manage your checkbook and handle basic accounting tasks, such as sending invoices to your clients. Money travels in two directions, so you'll also need to pay bills and keep track of expenses.

Ratings

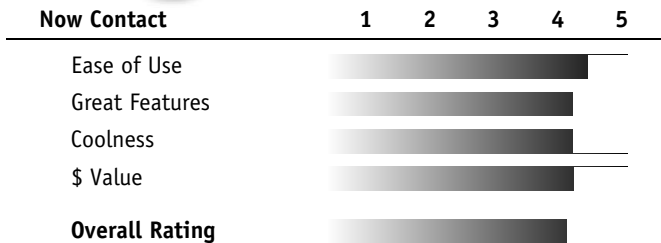

Word Processors

The word processor that you need depends on the kind of work you do. There are three high-end word processors for Macintosh: Word, WordPerfect, and Nisus Writer. Other options for less intensive word processing include ClarisWorks and WriteNow.

Word

Word is the one that's pretty much become the industry standard. There's a good reason for this—it's the most comprehensive. It does everything you're ever likely to do with text, and it translates transparently to DOS and Windows versions. It also preserves formatting tags when text is imported into page layout programs. Word 6 has a very good feature for those prone to computer crashes. It automatically saves your work as often as you tell it to, and if you do crash with unsaved text, you can generally retrieve it from the work file that Word places in your active folder. It is, however, a very large, rather slow program, even though it's supposedly accelerated for Power Mac. It has an excellent help system, which is fortunate, because the program is much too complicated to run without help close at hand. If you expect to do a lot of word processing, or if you're involved in desktop publishing, you'll have to bite the bullet and go for Microsoft Word. Your clients will expect you to have it.

Ratings

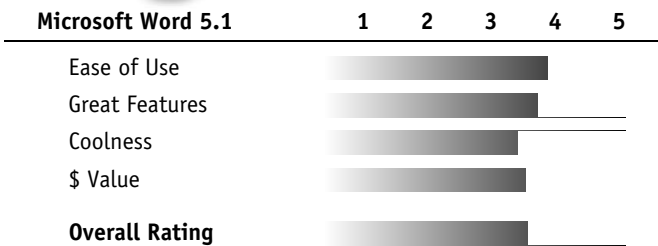

Ratings

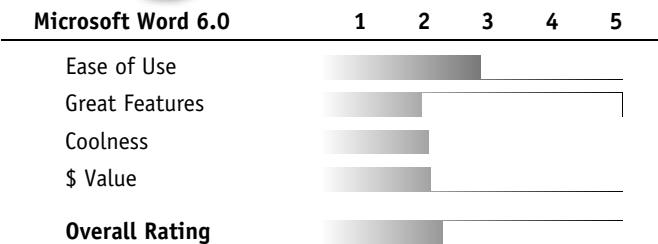

Nisus Writer

Nisus Writer has advantages if you need to work with languages other than English. It supports more than 18 different languages, including Arabic, Hebrew, Japanese, and Russian, as well as those that use the Roman alphabet. It even has a right-to-left ruler for those languages that are written in the opposite direction as English. It has a few other gimmicks, too. Most word processors support multiple Undos. If you make a mistake, and don't realize it right away, you can work backward and undo everything you've done until you reach the error. Usually, however, there's a limit to what you can undo. Nisus apparently expects you to goof...there's no limit! (On the other hand, if you're going to undo the whole document, why not just start over?) Nisus also enables you to keep 10 separate Clipboards instead of just one. You can edit the contents of the Clipboards, and copy and paste from all of them individually. You can cut several blocks of copy from the beginning of a document and paste them at the end without scrolling back. Nisus can select noncontiguous text. Take a phrase from the front of a paragraph, one from the middle, and a couple of words from the end. Hold the Shift key while you're highlighting the bits you want, and then copy them all. A powerful Find/Replace tool can find and replace a word or phrase in any open document, not just the one in which you happen to be working. It also has the capability to search closed files, giving you the option of opening them and making changes if the search target is found.

Ratings

Nisus Writer	1	2	3	4	5
Ease of Use	████████████████████				
Great Features	████████████████████				████████████████████
Coolness	████████████████████				████████████████████
\$ Value	████████████████████				████████████████████
Overall Rating	████████████████████				████████████████████

WordPerfect

Early Macintosh versions of WordPerfect came to be known by disgruntled users as WordImperfect. It originally retained too many DOS characteristics to satisfy users familiar with the easy and intuitive MacWrite. In the years since it first appeared, it has gotten better. Today, WordPerfect does everything moderately well, if not spectacularly. Its strength is versatility. It has the most complete set of graphics tools of any of the word processors. You can place watermarks (ghosted images or designs imprinted behind text on a page) and overlays (graphics superimposed on the text) with the click of a single button. WordPerfect can save pages of text and graphics in HTML for World Wide Web publishing. It can save documents in formats that are compatible with almost any other text handler on any platform. It can even password protect individual documents. Despite its good points, it has never really caught on with Mac users. The recent sale of

WordPerfect, first to Novell, and then to Corel, leaves its future uncertain at best. Having shown an interest in the Mac market by finally bringing us CorelDRAW! for Macintosh, many experts feel that the company will decide to maintain and upgrade the program. Ask about its future before you buy.

Ratings

WordPerfect	1	2	3	4	5
Ease of Use					
Great Features					
Coolness					
\$ Value					
Overall Rating					

What a Web We Weave...

Johann Gutenberg's printing press caused the most drastic change ever in the way information was spread. In 1989, a second, drastic change occurred as a result of a project started by Tim Berners-Lee at CERN, the high-energy physics laboratory in Switzerland. His goal was simply to share information with other scientists but, once begun, Berners-Lee's project grew into the World Wide Web. Today, there are well over fifty million people connected to the Web, and the number of Web sites, or servers, is increasing—literally—by the minute.

A Web site consists of one or more *pages*, which can include pictures, sounds, text, and QuickTime movies, as well as links to other pages at the same site or elsewhere. Web sites are viewed using a Web browser, which connects to the site's address, or URL (Uniform Resource Locator). The best known Web browser is Netscape, but you also might use Mosaic, America Online's Internet browser, or even a text-only Web server like Delphi.

Web pages are formatted using hypertext style tags defined in a simple markup language called HTML (HyperText Markup Language). The browser interprets the HTML tags and displays the page on your screen. If you have worked with style tags in a program, such as PageMaker, you already know much of what you need to design Web pages in HTML.

A basic page can be created in any word processor. In the beginning, that was the only way to do it, applying tags yourself from a list of HTML commands that defined the way each element was displayed on the page.

HTML tags consist of a left-angle bracket (<), a tag name, and a right-angle bracket (>). Tags are usually paired (for example, <H1> *tag instruction* </H1>) to start and end the tag. The end tag looks just like the start tag except a slash (/) precedes the text within the brackets. Text size is controlled by adding numbers to the tag instructions, for example H1, H2, and so on getting smaller as the numbers get bigger up to 6.

continues

continued

Here's a very simple HTML document:

```
<HTML>
<H1>
Welcome to my Home Page!
</H1>
<H2>
There's nothing on it yet.
</H2>
</HTML>
```

Netscape displays this as 24- and 18-point black type on a gray background. Not very imaginative... Fortunately, there's a much better way. Today there are a number of WYSIWYG editors that enable you to work in a more familiar environment, much like desktop publishing. Arguably the best of these is Adobe PageMill, although you can use any program that translates text into HTML. ClarisWorks can do it, as can other WYSIWYG programs, such as HoTMetaL or GNNPress. A freeware program, GNNPress is distributed by America Online. HoTMetaL Pro is available commercially, but a free trial version can be downloaded from the Web.

To use any of these HTML editors, first plan your page on paper. Decide what's to go on it, what links you want to include, what graphics are appropriate, and how your readers will move from one page to another. Keep it simple at first. You can always add more goodies and reload your page to your Web server later. The text tools shown in the figure below are typical.



Using PageMill to lay out a Web page

You are more or less restricted to the available fonts and sizes for setting text, although you can create headlines in a graphics program and import them as GIFs. Don't do this for important content, however, because many people browse the Web with the image loader turned off and, thus, will only see a picture icon instead of your message.

In PageMill, you can change background colors and type colors by selecting Page from the Attributes Inspector, and selecting custom colors from the Apple Color Wheel. You can even add patterned or textured backgrounds if you want, but be careful not to overdo the graphics. Elaborate backgrounds and large images take a long time to download.

Adding links is easy. A link takes you from one page to another destination, which could be another place on the same page, another page of your Web site, or anywhere else on the Web. You can include links as part of a table of contents or imagemap. An imagemap is a graphic to which you add "hot spots" with a different link to each area of the image.

Adding forms to a page is a bit more complicated. You might use a form to collect names and addresses for a mailing list or to let a reader send you email. Setting up the actual form is fairly simple. You use check boxes, radio buttons, pop-up menus, and text entry fields, but in order to make something happen when your reader clicks the submit button, you also need to write a CGI (Common Gateway Interface) script. This is done using a programming language like AppleScript or Perl. Consult your Internet provider for assistance with CGI scripting.

After your Web pages are finished, upload them from your hard disk to the Web server. Be sure that all associated files, GIF images, and subfolders are in the same folder. If you are careful to save everything into a Web site folder as you lay out the page, you won't risk breaking links by moving files around later. Your Internet Service Provider (ISP) will provide directions for uploading your pages to the server, and will assign you a URL address for your page.

ClarisWorks

If you deal mostly with graphics and illustration or with some other art-related field that doesn't demand advanced text manipulation, you've probably already got all the word processor you need in ClarisWorks. ClarisWorks has been included with virtually every Mac sold within the past several years. It includes a word processor that's entirely adequate for letter writing, business mailings, and limited DTP. Version 4.0, to which you should upgrade if you have an earlier edition, includes stationery for newsletters, flyers, invitations, and much more. It can handle outlines and apply style sheets to text. It enables you to create your own styles and provides some preformatted ones to get you started. The word processor even can create Web pages using HTML. ClarisWorks comes with all kinds of goodies and gimmicks, including a library of inline graphics to brighten up your memos and newsletters. You can add your own favorite bits of art, your scanned signature, your logo, your letterhead, or whatever you like to use to perk up your pages.

WriteNow 4.0

If, for some reason, you either don't have ClarisWorks or prefer to use a standalone word processor, WriteNow 4.0 is worth considering for several reasons. First, it's the least expensive. That's an important factor when you're just starting out. Second, it's compact. It requires less than half the disk space and memory of the other word processors. Third, it can do almost everything the "big" word processors can do. Fourth, it's simple and intuitive to use. Fifth... well, you get the idea. WriteNow has two really good features—speed and size. It's the fastest to open, fastest to change fonts, fastest to count words. Some of its speed comes from not needing to spend much time chewing through its own code. It's also compact. The entire program, including the dictionary and thesaurus, fits on two diskettes and demands only 2.2MB of hard disk space and a scant 600KB of RAM. Despite its small size, it has most of the features you would expect to see in a program costing three times as much and weighing even more. WriteNow gives you an easy-to-use style sheet with both paragraph- and character-based styles, tables, footnotes, spelling checker, thesaurus, Print Preview, and Balloon Help. Like ClarisWorks, WriteNow comes with a good selection of sample documents, including newsletters and resumes, which you can use as stationery to create your own documents. Unfortunately, like WordPerfect, several changes of ownership have left its future in doubt. If it's still around, it's well worth owning.

Letters and Other Good Words

The word processor doesn't mince words, nor does it slice and dice them. It does, however, enable you to cut and paste, drag and drop, and lay out your pages on the screen. More important, it gives you the tools to write correctly. Today's word processors include powerful spelling checkers and often helpers such as a 1.4 million word thesaurus, a grammar checker, and an outliner to help you organize your thoughts.

The chances are excellent that most of what you do with your word processor is very elementary. You use it to write letters, to address envelopes, and perhaps to draft proposals or estimates. You will probably discover that you spend much more of your time editing what you have written than actually typing it. For this reason, make sure that you're comfortable with your word processor's editing features. If you're a touch typist, it's helpful to use a program like Microsoft Word, which supports a great many keyboard editing commands. You can do much of your editing without ever taking your fingers off the keyboard. The added convenience of an extended keyboard with function keys pays for itself in time saved.

On the other hand, if typing is not your strong point, stick with ClarisWorks and spend the money you save on a copy of Business LetterWorks. LetterWorks is quite possibly the best idea since the Mac itself. It's a compendium of 400 pre-written letters and other business documents on a disk and in book form. Simply flip through the book (or use the index) to find the kind of letter you need to send. Along with each letter are helpful hints on how to customize it and when to use it. When you open the letter in your word processor, you simply replace the sample names and addresses with your own information and add whatever details are needed to fit it to your situation. The types of letters and documents provided range all the way from press releases and new customer

solicitations, to letters handling complaints, collecting overdue bills, and even explaining why your payment is late. Business LetterWorks is one of several volumes of pre-written letters from Round Lake Publishing. There are also Personal LetterWorks for social and business correspondence, and volumes related to consulting, legal documents, sales, and personnel management.

The Envelope, Please...

One of the biggest mistakes beginners make when sending business or personal letters is to print a beautifully laid-out letter, and then mail it in a hand-addressed envelope, because they haven't figured out how to print one. Granted, a lot depends on your laser printer. Some kinds of printers require that you purchase a separate tray for envelopes. Others can feed one at a time, bypassing the tray. If you want your correspondence to look appropriately professional, spend the time to read the printer manual and find out how to print the envelopes for your letters. Setting up the envelope to print isn't difficult. ClarisWorks has an envelope assistant that walks you, step-by-step, through entering the addresses, and then through the page setup dialog to make sure your envelope ends up with the print facing the right direction. If you make a mistake, you can see it and correct it before you print. The figure below shows an incorrect setup.

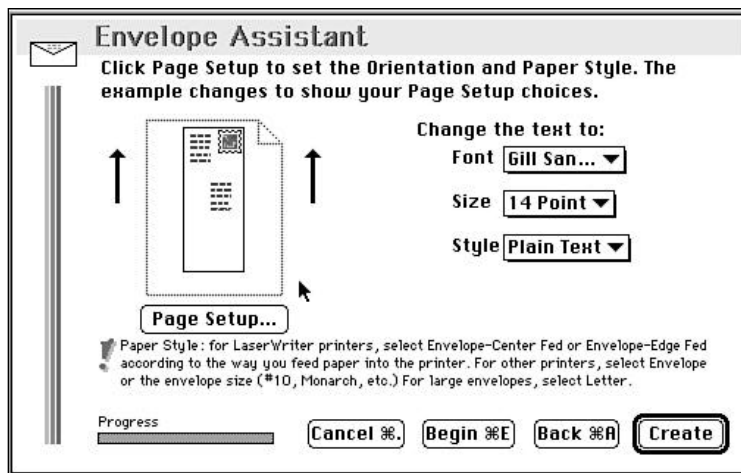

Figure 20.1

Oops, forgot to change the paper orientation to landscape.

Other word processors handle envelopes differently but with equal aplomb. In Microsoft Word 6.0, select Envelopes and Labels from the Tools menu, and a dialog box like the one shown in Figure 20.2 appears. Enter the address and choose the correct envelope position for your printer. If you want to use an odd-size envelope, Word gives you many options, including European sizes as well as Monarch and U.S.# 9,10,11, and 12. You also can select Options and then Custom to enter your own envelope or label dimensions.

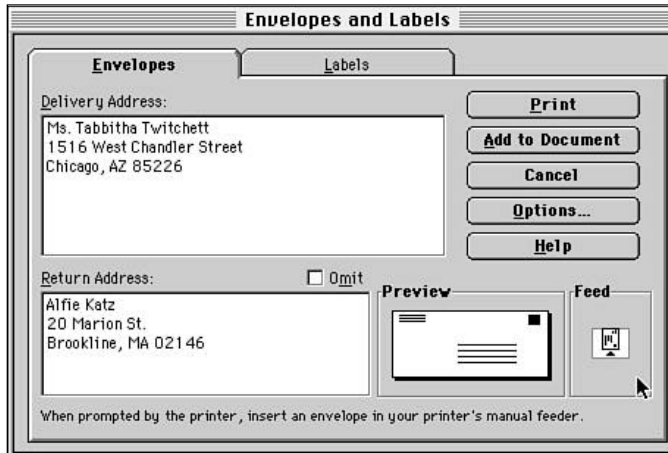

Figure 20.2
Enter the address
in the window.

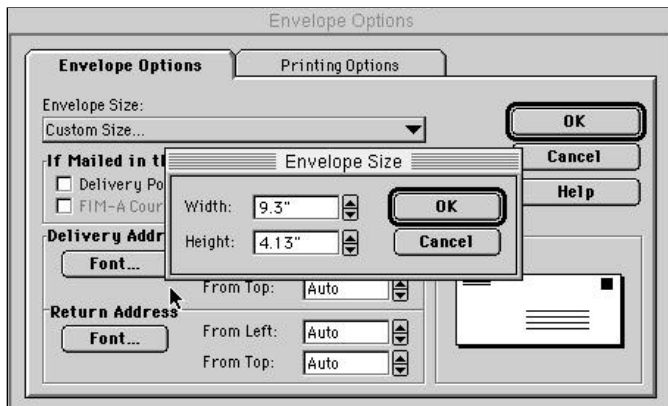

Figure 20.3
Custom envelope sizes

Merge Right...

When you want to send a single letter, personally addressing each one is fine. Sending a mass mailing, however, requires different tricks, but can be accomplished with any of the current crop of word processors. Mail merge is a method of sending personalized letters to a large group of people, using the same basic letter, and merging their names and other data into blank fields in the letter. It's a three step process. In order to do a mail merge, you must first create the letter or other document to be personalized. Decide what parts of the letter you want to personalize. Figure 20.4 shows a typical example.

Next, set up the data source, which is a list of the categories of data that go into each blank field in the letter. These will probably include such items as first name, last name, address, and so on. Note that the field names can't contain more than 40 letters and must start with a letter, not a number or punctuation mark. Field names also must not contain spaces. Run words together, as in "firstname," or use an underscore to separate

words, as in “last_name.” You can create this data source in a database, such as the one that’s included in ClarisWorks, or in a text file, separating the categories with tabs or commas. If you are using Microsoft Word, you can create the data source file using the Mail Merge Helper. Clicking the Create Data Source button opens the dialog box shown in Figure 20.5, which includes a list of commonly used field names. Select the ones you need and add any that aren’t provided. Enter the data, and you’re ready to merge. It’s always a good idea to check your merged letters on-screen before you print them, just to make sure you haven’t left a field blank or formatted data incorrectly. Word’s Mail Merge also has the extremely useful capability to custom print a set of mailing labels or envelopes at the same time that it’s merging the addresses and letters.

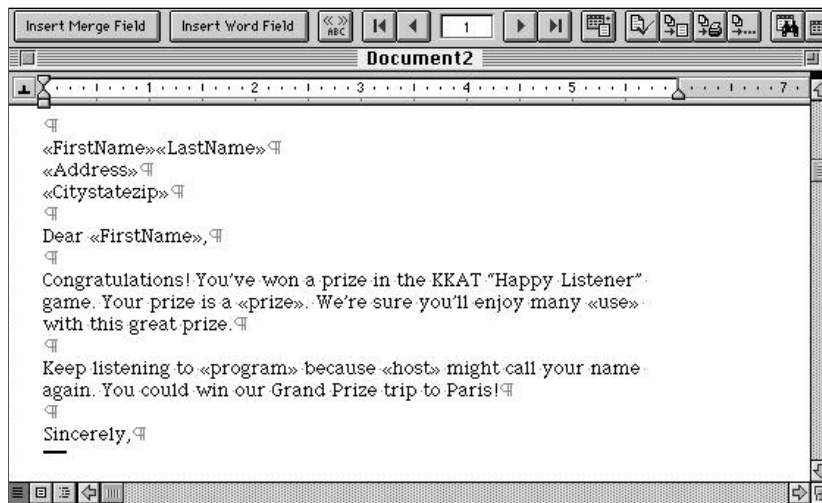

Figure 20.4
Note the punctuation (international quotes) around the fields.

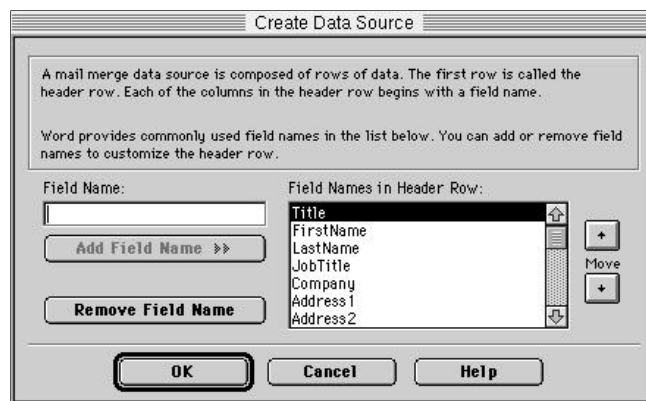

Figure 20.5
The Create Data Source dialog

The Most Common Word Processing Mistakes (and How To Avoid Them)

There are several mistakes that most beginners make when using a word processor for the first time. They happen because most of us learned to use a typewriter before we graduated to the computer. The typewriter does several things differently, mainly spaces, quotation marks, and apostrophes.

Traditional typewriter type is monospaced. Each letter is the same width, whether it's a fat capital "W" or a thin lowercase "i." In order to make the spaces between words and sentences look right, typists were taught to always use two spaces after a period. Most computer type, however, is proportionally spaced. The wide letters occupy up to four times as much space as the thin ones. Therefore, you should leave only one space after a period, not two, in order to make the spacing look right.

Quotation marks and the apostrophe (which, of course, is a single quote) are omnidirectional on the typewriter. There's only one set of quotes and one single quote. You use the same one at either end of the quotation. Computers include typographer's quotes in their font libraries. These are the kind we sometimes call "curly" quotes. The computer, however, uses the standard typewriter keyboard, which has just one key for quotes. If you look in your word processor's Preferences or Options dialog box, you'll find an entry for *smart quotes*. This option substitutes the appropriate left or right quote marks for the "dumb" typewriter quotes.

Do you know the difference between an em dash, an en dash, and a hyphen? A hyphen joins together two pieces of a word, or two words in a phrase. Em dashes are used—in informal writing—to set off a phrase or thought. Typists often used two hyphens to represent an em dash. Word processors use the combination Option+Shift+- to place an em dash. En dashes are used with numbers. They are made with the combination Option+-.

Spelling checkers have long been standard equipment in word processors. They scan your pages, matching words against a dictionary and asking about words that don't match and suggesting a possibly correct word instead. They're not always on target, but they do catch many errors. The current versions of Word and WordPerfect include options that automatically fix spelling errors as you type. Word offers AutoCorrect, which fixes common spelling mistakes (for instance, changing "hte" or "teh" to "the") as soon as you've made them. You can customize AutoCorrect to catch your most common spelling, capitalization, and punctuation errors. QuickCorrect, in WordPerfect, does much the same thing. Either program can expand abbreviations you enter into the full word or phrase, helpful if you type the same words or phrases over and over.

Some word processors, including Word and Nisus Writer have built-in grammar checking programs. WriteNow comes bundled with one, Grammatic Mac, that's a separate application. Grammar checkers work much like the spelling checker, comparing text against a set of rules. Unlike the spelling checker, however, the grammar programs often make mistakes, flagging a perfectly good sentence as incorrect and occasionally skipping mistakes that an elementary school student would catch. You can customize the grammar checker to ignore particular rules or to use the "casual" rather than the "formal" rule set. Doing so may help to keep it from questioning too many non-errors. Don't let the presence, or absence, of this "feature" influence your choice of word processor. They're essentially worthless.

Most grammar checkers also rate your writing according to a readability index, determining how many years of school you'd need in order to understand the material. These indices are based on the ratio of long words to short words in a sentence, and really shouldn't be taken too seriously. The readability index for this paragraph is 11.48.

Whatever Works...

When we were kids, "Gimme the works" used to mean not just the hot fudge, but also the marshmallow, nuts, whipped cream, and the cherry on top of the sundae. Today, "the works" has a much less interesting connotation. A Works program combines several different applications into one. You can write letters, balance your checkbook, and print a yard sale poster, all from the same program.

There are currently just two works programs for Macintosh: ClarisWorks and Microsoft Works. Others have come and gone, which might suggest that the notion isn't practical, or simply that these two programs are so superior to the others that there's no reason for any other publishers to try the concept. The truth is, the integrated works program *is* a practical idea, but only for users who need to do a little of everything, without needing a heavy-duty powerhouse program in one particular area. Works programs cover the basics by providing modules that include word processing, drawing, database management, spreadsheets, and even telecommunications. They do all this in a relatively small amount of space. ClarisWorks, for

Ratings

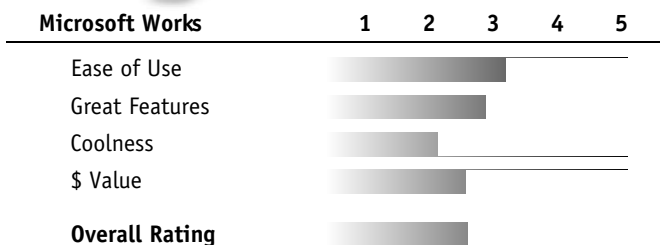

Ratings

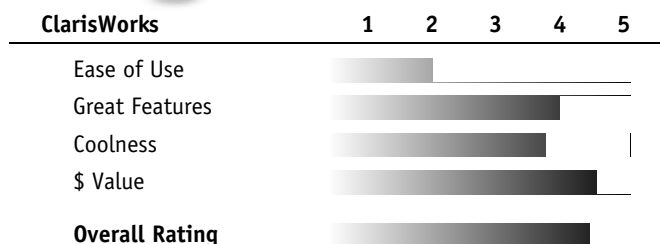

example, needs only 1.4MB of RAM to run and less than 2MB of hard disk space. Microsoft Works occupies a little over 5MB of hard disk and requires about 2MB of RAM, which still is pretty good, especially if you consider that Microsoft Word eats up nearly five times as much hard drive real estate. A Works program is a good choice for a PowerBook or Duo, because it packs so many functions into a small space. They'll also save you money. The current street price for ClarisWorks is \$129. (Better yet, it comes free with many new Macs.) If you were to start adding up the cost of a standalone word processor, telecommunications program, spreadsheet, database, and drawing program, you would come up with a figure that's close to five times as much.

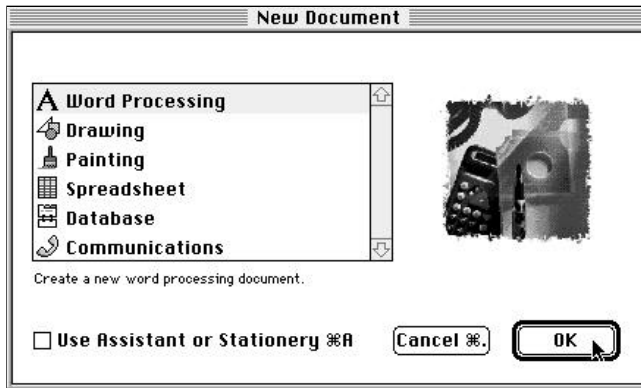

Figure 20.6
After you open ClarisWorks, select the module you want to use from this screen.

People who've used both generally agree that ClarisWorks (see Figure 20.6) is a better choice than Microsoft Works. Claris' word processing module is more than adequate. It's based on MacWritePro, and seems to do almost as much and as fast as the standalone word processor. On the other hand, the Microsoft Works word processor is its weak point. It's not intuitive, and it's slow. Instead of providing Font, Size, and Style menus, toolbar icons at the top of the screen turn into pop-up menus when you click the mouse while pressing three keys. Speed is a problem with Microsoft Works in general. It runs slowly even on a Power Mac. A moderately good typist can get ahead of it and possibly lose text. It also lacks hyphenation, so you probably wouldn't want to use it for justified text, such as in newsletters or brochures.

Microsoft Office

There's another kind of semi-integrated program called a *suite*. The one that you're most likely to see on the shelf or in a catalog is Microsoft Office. Technically, it's not a Works program, but rather a collection of standalone applications. In this case, you get Excel, Word, and PowerPoint, plus a launcher called Microsoft Office Manager, which gives you quick access to the three programs from the menu bar.

The advantage is that you get three full-featured applications rather than scaled down “works” versions. The disadvantages are that the bundle is expensive, uses a lot of hard disk space, and, when you buy the Office package, you have to buy printed manuals separately. They’re, however, included as text files on the CD-ROM. Again, ask yourself whether you will use more than just Word. If you require serious spreadsheet and database software, or presentation software, this package will meet your needs, but if you’re only writing letters, it’s considerably more software than you either need or want.

The Fax of Life

These days nearly everybody has a fax machine. We fax proofs to clients, orders to the deli and pizza store, maps to show visitors how to find the office, and music requests to the radio DJ. We get faxes from vendors, clients, and even Grandpa. My teenaged son handled much of his college applications by fax. A friend faxed a photo of a homeless kitten to a potential owner, and it was adopted on receipt. You don’t need a separate fax machine for most of these functions. You can send faxes from your Mac with a combination fax/modem, and these days you can buy one for about the same price as a modem that isn’t fax-capable.

There are advantages to sending faxes from the computer. The main one is that your pages arrive looking sharper and cleaner than those sent from a standalone fax machine. The Mac treats the fax application and modem as if it were a printer. When you intend to send a fax, you can use the Chooser to select the fax software or use $\text{⌘}+\text{Option}+\text{P}$ to open the Fax Print dialog box.

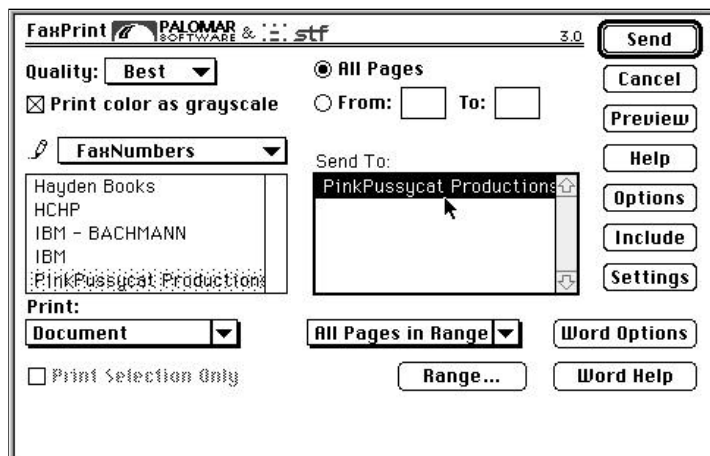

Figure 20.7

Drag the name of the recipient from the address book list to the destination list and click Save. You’ll then be asked whether to send immediately or hold.

It sends the image of the page exactly as if it were sending a bitmapped graphic to a printer. (All faxes are technically graphics, even if they're nothing but pages of text.) You can save money on long-distance charges by directing the fax software to send your documents at night, after the rates go down.

You also save time when you send faxes from the Mac. You don't have to look up the number each time. It is stored in the fax software's address book. You don't have to fill out a fax cover sheet by hand. It's done automatically. You don't have to print the pages and then feed them one by one into the fax machine. You don't have to stand there and make the call. The Mac takes care of everything, keeping a log with the time, number called, pages sent, and any comments. If the fax wasn't received successfully, the computer keeps trying or, if you prefer, stores the fax and waits for further instructions. While the fax is sending you'll see a progress box like this one.

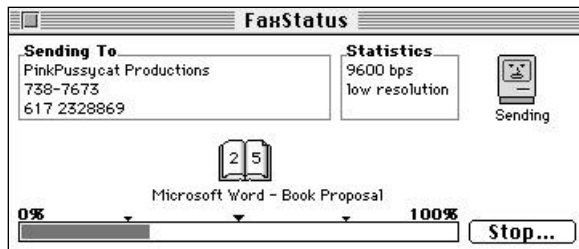

Figure 20.8

The box tells you what you're sending, where, and how much has been sent.

The disadvantage of faxing from the computer is that you can only send something that's already in the computer. You can't fax a cartoon from the daily paper, or a magazine article, or a piece of non-Mac art, unless you have either a standalone fax machine or a scanner that can translate the piece of paper into a Mac file. In many cases, it makes sense to have both a fax machine and a fax/modem, especially if you expect to be on the receiving end of the fax line. It makes even more sense to have the fax machine on a second phone line, which it can share with the modem—as long as you remember to turn off the modem's AutoAnswer function. If you have both a standalone fax machine and a fax/modem, you can send yourself faxes of pencil sketches or magazine clippings, rather than scanning them. You also can fax text pages to the computer, and use the fax software's OCR (optical character recognition) function to convert the fax back into editable text. It's not completely reliable, but it's faster than typing.

When you buy a fax/modem, you'll get a fistful of software with it. Typically, there is a disk for America Online, one for CompuServe, and possibly one for Prodigy. You'll also get a lite version of a fax program and a basic telecom program, either the shareware application Z-Term, Microphone Lite, or some other text-based software. Should you spend

money for even more faxing and communications software? Possibly. The current version of FAXstf, the leading fax program for the Mac, offers many convenient features including a floating toolbar that enables you point-and-fax from any text or graphics application, fax forwarding, and fax broadcasting. In one operation, you can send the same fax to as many as 130 phone numbers, and you can schedule it to happen at your convenience.

A Better “Type” of Fax

Several years ago, Adobe Systems did a study to determine which fonts were best for faxing. Not surprisingly, they found out that the fonts that were easiest to read were: Courier, Helvetica, New Century Schoolbook, and Palatino. These could be recognized even in smaller point sizes (down to about 8 points) and even when sent “standard” quality. Unfortunately, they’re not necessarily the most interesting fonts.

For maximum legibility, make sure that you use either TrueType fonts for your faxes, or have Adobe Type Manager. Graphics fax better if created in drawing programs and saved as PICTs rather than as Paint images. PICTs retain their fill patterns better and can be resized without distortion.

What about those online services disks? Each service that sent you a disk is offering you some free time to explore, and all are definitely worth visiting—especially at that price. Both CompuServe and America Online have a great deal to offer the small business owner and the graphics/DTP professional. You’ll find vendor forums run by companies such as Adobe, Fractal, and Macromedia as well as forums run by other small business people, artists, and allied professionals. You also will find tremendous libraries of fonts, graphics, photos, useful shareware and freeware applications, as well as demo versions of commercial programs, software updates, and the latest news and tips on using your favorite applications.

You can use the online services as a jumping off point for the Internet, as well as a mailbox for your email. You can even send files back and forth between CompuServe or America Online and most other Internet email servers. It’s quicker and cheaper than sending your files on disk and just about as reliable. Virtually every word and picture in this book has been sent back and forth through email from the authors to the editors, to the tech reviewers, and back. A great many local print shops and service bureaus are now accepting jobs by email, and more can be expected to follow. It’s cheaper and faster than sending a messenger to pick up the work.

Accounting for the Mathematically Challenged

Let's face it, a lot of us ended up in the arts because we were no good at math. Now, here we are years later, trying to manage a business and a checkbook and taxes and cash flow projections and still feeling very uncomfortable with numbers. There are a couple of ways to get around this. One is to hire a good accountant, and let him or her take care of the arithmetic. A better way is to invest a few dollars in an accounting program and learn to do your own books. It's not difficult, and you'll have a much better idea of how your business is doing on a day-to-day basis.

There are several good small business accounting packages: QuickBooks from Intuit, BestWare's M.Y.O.B. Accounting, and Peachtree Accounting. All are relatively inexpensive, with a street price around \$100 or less, and relatively easy to learn. Of the three, M.Y.O.B. is probably the most user-friendly, but all include on-screen help and well-written manuals.

To set up your accounts in any of them, you follow a procedure called a start-up interview. Begin by entering your business name and address, whether you use batch posting or real-time posting, whether your books should be set up on an accrual or cash basis, and the dates for the start and end of your fiscal year. Then, choose a type of business that most closely matches yours. There are categories for advertising agencies, graphics artists, photographers, crafts people, and even freelance writers. There are also categories for everything from accountants to video rentals. The figure shows part of the M.Y.O.B. interview.

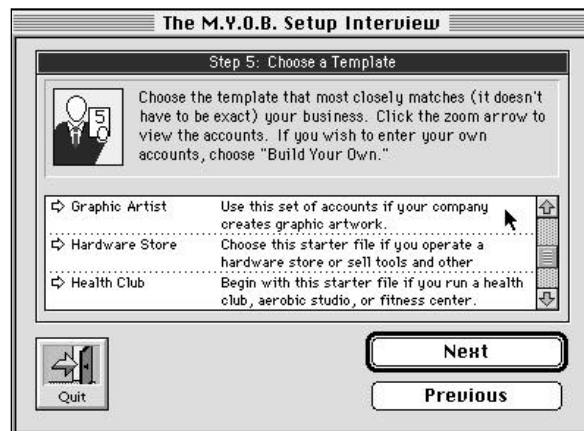

Figure 20.9

There's a category for almost any kind of business.

The accounting program then creates the basic books for you, assigning the kinds of accounts and data entry categories appropriate to your business. All you need to do is to fill in the numbers and the names and addresses of your customers and suppliers. If you have employees or if you're paying yourself a salary, all of these programs can also handle the payroll and payroll taxes.

One of M.Y.O.B.'s strengths is its graphical interface. After you have gone through the setup interview, each time you open the program you're taken to a command center with icons and flowcharts. Simply click the icon for the area where you want to work, and you'll see the appropriate flowchart. Clicking it takes you to the data entry form or journal page for that function.

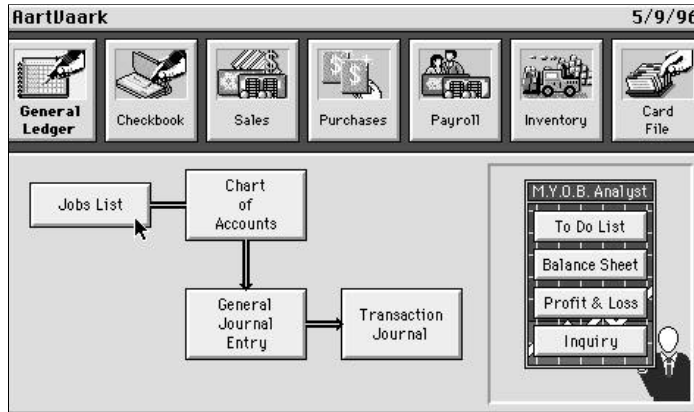

Figure 20.10
Click any of the flowchart items to begin the process.

Peachtree Accounting's interface also features flowcharts, which it pops up from a strip of file folder tabs at the bottom of the screen. These flowcharts function as menus to open windows and perform tasks. Some take you to the appropriate places to make journal entries or to write a check. Others are much less intuitive, and you might find yourself, as I have, printing blank invoices.

Peachtree gives you the option of custom designing your forms and reports, although the customization process is far from intuitive. The Form Designer is meant to be used by an object-oriented programmer rather than a graphics artist. You build an image of your form on-screen using text objects, data objects, shape objects, picture objects, and command objects. It's not a task for a novice and is probably beyond the abilities of the average bookkeeper/receptionist/office jack-of-all-trades. If your business requires many custom forms, consider hiring a consultant to do the programming and to set up your systems.

Things to Consider When You Choose an Accounting Program

- 1 Security.** Does the program allow password protection? Even if you work at home, there are times when you will want to hide your information from curious eyes. More important, you need to protect it from unauthorized changes. Password access is easier and friendlier than making your Mac off-limits to the rest of the family, or office help.

- 2 Cash or accrual.** Will you be maintaining your books on a cash or accrual basis? Cash-based accounting records income and expenses when cash is received or disbursed. When, for instance, you write a check to pay your phone bill, you increase telephone expense and decrease cash via a check. Therefore, no expense is recorded until that check is written. Using the accrual method, the expense is recorded when the telephone bill is received. You enter it as a purchase, increasing telephone expense, but instead of reducing cash with a check, you offset it against accounts payable. When the bill is paid, and a check is written, you not only reduce cash, you are also reducing accounts payable. Income and expenses are recognized at the time they are incurred, when you record the sale or purchase, not when cash is received or disbursed. The main difference is that under the accrual method you can track the payable on your records via an Aged Payables Report showing all the vendors to whom you owe money. This enables you plan your cash flow and manage your resources better than simply holding on to your bills and paying them when there is money in the checking account.
- 3 Recurring expenses.** There are a few bills that come up every month, such as rent, fixed loan payments, and depreciation. How does the accounting package handle them? It should remind you to process them each month as they fall due and should remember the amounts from month-to-month so you don't have to reenter the details. M.Y.O.B. has a calendar and to-do list that reminds you automatically.
- 4 Data entry.** How easy is it to write a check or send an invoice? A good accounting program should provide a recognizable form and automatically post the numbers to the appropriate journal or ledger. The more the form looks like a check, purchase order, or invoice, the easier it is to work with.
- 5 Reports.** Can you get the information you need easily and in an understandable form? The last thing you want to do is spend hours poking around trying to figure out whether you're making money. Your accounting program should tell you, with a couple of mouse clicks, exactly where you stand. M.Y.O.B.'s Cash Flow Projection report analyzes your receivables and payables and projects cash balances for any period you specify.

Keeping Time

How do you bill your clients, by the job or by the hour? Either way, it's helpful to know how much time you have spent on a project. If you charge by the hour, it's more than helpful, keeping an accurate record is a necessity. There are lots of ways to do it. You could make up a time sheet and pencil in your start and stop times, but an easier way is to use one of the many programs that track the hours for you.

TimeTracker, from Maui Software, is an inexpensive (\$25) shareware program with some impressive features and a very easy-to-use interface. It enables you to keep track of several jobs at once, and you can do so just by clicking a button on your screen. TimeTracker has an expandable—or collapsible—window, which tucks neatly into a corner of the desktop. If you're working on a project for one client, and another calls, it's

easy to stop the clock on the first project and start the clock on the next one, even as you're picking up the phone! There's even a coffee break button. In the figure below, we're about to take a break.

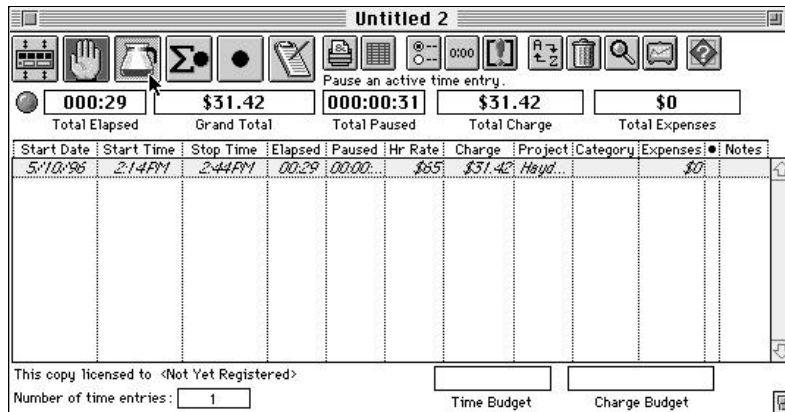

Figure 20.11
Click the coffeepot when you need a break.

You can enter your hourly rate and watch the dollars increase as you work, a morale-booster when you're working long hours on a project you might not otherwise enjoy. Because TimeTracker figures your time to the minute, your billing is more accurate than if you simply rounded up, or down, to the closest quarter hour. Over the course of several jobs, it can easily pay for itself. If you charge for materials, TimeTracker can help you keep track of them, too. Place them under notes, and the amounts are added automatically. It even enables you to specify different rates for different kinds of work if, for instance, you charge more for creating illustrations than for doing a paste-up.

A more sophisticated version of this program, called TimeSlice, has some additional features. Notably, you can assign different hourly rates for different clients, as well as for different categories of work. It also offers export and customizing features and costs a bit more as well.

Karl Bunker's MultiTimer is another good, very inexpensive shareware program for keeping track of your working hours. It has one extremely clever feature, in addition to the expected time-keeping functions. You can direct it to open a specific application or document when you start timing your work on the document. If you have several projects going at once, you can create a different MultiTimer module for each and open each document automatically as you prepare to start working on it. Although MultiTimer doesn't have the coffee break button that TimeTracker and TimeSlice have, it does keep a paternal eye on you. If you stop working without stopping the timer (which really *does* sound like a stopwatch), it displays the following dialog box when you return. Whether you subtract the time you weren't actually working is up to you.

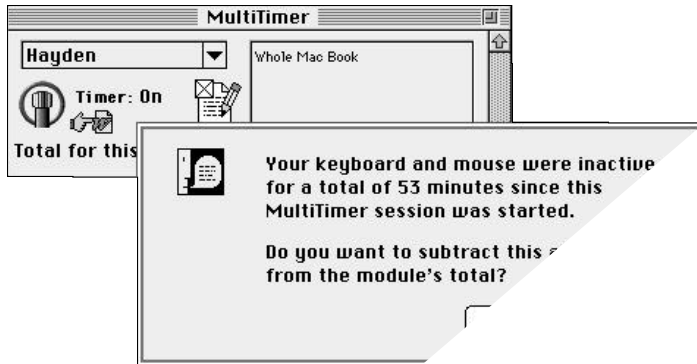

Figure 20.12

It's not quite as bad as having the boss looking over your shoulder.

Paperwork Made Simple

DesignSpec is a commercial program for graphic designers and print brokers, originally developed by a designer and print buyer for in-house use. It addresses a fairly narrow range of businesses, but could be extremely useful if yours is among them. Its purpose is to help you generate estimates, invoices, statements, and detailed reports quickly and accurately. It tracks time and materials, but more important, it is a communications tool between designer and client and designer and printer. The program includes a set of comprehensive, easy-to-read forms that can be filled out with all the relevant design and printing specifications and faxed to your client, printer, or prepress vendor. When all the details of a job are carefully spelled out on paper, and all the potential costs are figured in, there's that much less that can go wrong.

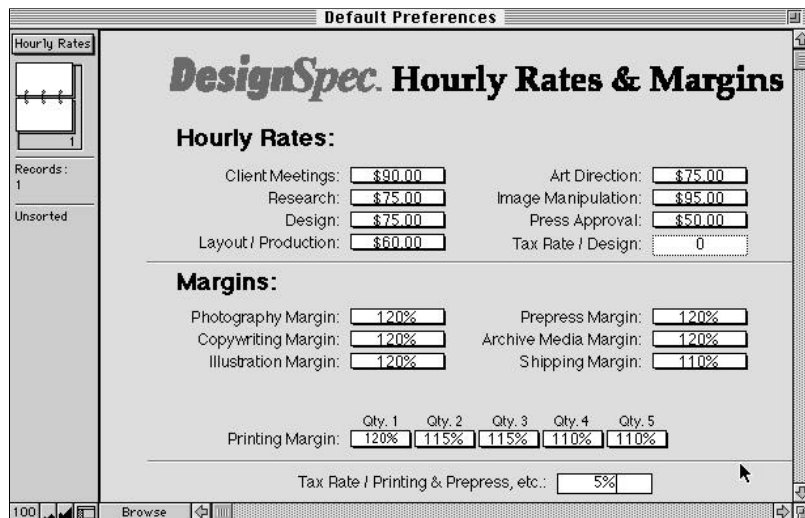

Figure 20.13

DesignSpec requires that all of the boxes be filled in, but it provides default numbers for all costs and percentages.

If you have ever used Claris FileMaker Pro, the interface will seem quite familiar. Although this is a standalone application, it uses the FileMaker engine. The process starts when you enter your pricing information into the program's database. There are rates for research, client meetings, design, layout, art direction, and even one for press approval. There's also a place to add mark-up percentages, which DesignSpec calls *margins*, for services you subcontract on behalf of your client, such as photography, illustration, and copywriting. Because most graphics arts materials are stored on some sort of digital archiving media, there's a page on which you can enter your costs for DAT tapes, magneto-optical tapes, removable hard disk cartridges, and other media. The program automatically marks these up by the percentage you've designated. There's also a page for the costs of such items as photo conversions, imagesetter output, scanning, and laminate proofing, and these costs also are marked up automatically by whatever margin you prefer to use.

Ratings

FileMaker Pro	1	2	3	4	5
Ease of Use					
Great Features					
Coolness					
\$ Value					
Overall Rating					

The main menu features a series of buttons labeled for creating bid requests, worksheets, estimates, and invoices. When you click the New Project button, you have to specify a client. If you haven't yet done so, you need to enter the information for your client. Clients are assigned numbers in the order of their entry.

Notice that the pricing information has been carried over onto the Client Info and New Project forms. If some of your clients receive special pricing or if this project has special requirements, you can adjust the pricing here, and not change the standard prices. Then, enter the project description in the New Project form. From this form, you can prepare an estimate for the client, send a bid request to the printer or service bureau, and start a time sheet for the job. The client estimate form even has the appropriate legal boilerplate disclaimer and a space for the client to sign his or her approval of the cost and specifications.

DesignSpec

**DesignSpec.
Project Setup**

Client Name: Moses "Moose" Matthews
 Company Name: Moose's Sporting Goods
 Street Address: 56 Spring Lane
 City: Watertown
 State: MA
 Zip: 02174
 Telephone: 978-2567
 Facsimile:
 Sales Rep: Peter Sellers

Reference Number: 00502
 Cust. P.O. #:
 Date: 5/10/96
 Revised Date: 5/10/96

To Client Database
 Client Number
 1001

Duplicate Job
 Delete Job
 Main Menu

PROJECT DESCRIPTION
 "Moose on the Loose" Newsletter, Ad campaign, and in-store displays

Note: Every field on this screen must be filled out for DesignSpec to perform calculations in other forms.

Use Default Hourly Rates & Margins
 Use Client Hourly Rates & Margins

HOURLY RATES

Client Meetings:	\$90.00	Design:	\$75.00	Art Direction:	\$75.00
Research:	\$75.00	Layout / Production:	\$60.00	Image Manipulation:	\$95.00
				Press Approval:	\$50.00

Figure 20.14
 This form also must be completely filled in.

Time sheets are not handled quite as elegantly here as in the programs that do nothing else, but that's understandable given the fact that this application is based on FileMaker Pro. It keeps track of the date and your start and stop times by reading the Mac's clock and pasting the data into a spreadsheet. It can, of course, do the calculations and apply the information to the invoice.

This program creates nice looking invoices with all of the job notes and data included. What it doesn't do, and therefore you must do by hand, is export the numbers into a bookkeeping program, such as M.Y.O.B. or QuickBooks.

Bank by Modem?

Banking over the Internet is becoming a reality as this book is being written. The first bank-by-modem accounts will be strictly for home use, but it's fairly certain that small business accounts will follow soon after. Look for Intuit's QuickBooks to lead the way, because Quicken (Intuit's personal financial program) seems to be the software that the majority of banks are recommending and supporting for online account service. Intuit includes a special edition of Netscape Navigator that enables you to log on to the Intuit Web site, shown here, where you can read helpful business information or check for program updates. Unfortunately, it only reads that site. If you want to surf the Net, you must contact Intuit for a \$12.95 upgrade, or download a copy of Netscape Navigator from some other source.

Ratings

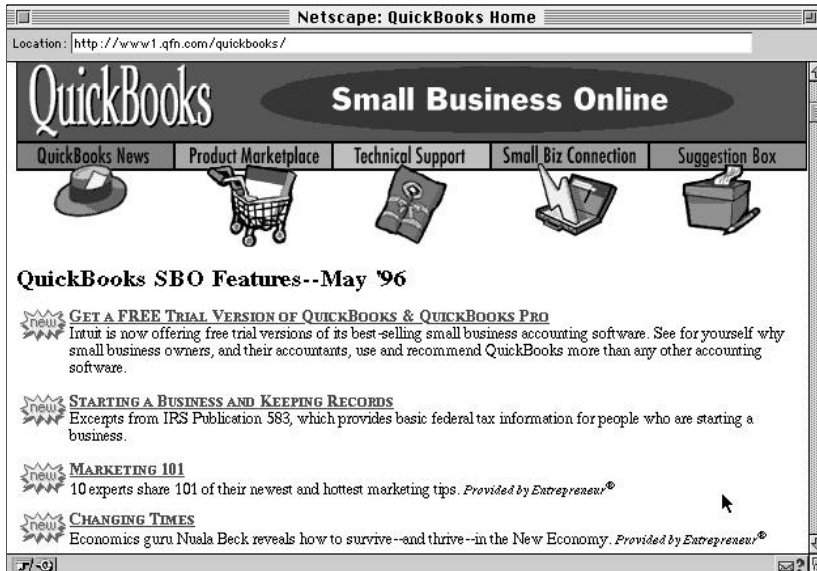

Figure 20.15
Intuit's QuickBooks Web site

Ratings



Getting Organized

Keeping track of the time you spend on various jobs is important, especially when you bill by the hour. But you also need to keep track of appointments, client meetings, deadlines, phone numbers, addresses, and whose turn it is to carpool the kids to soccer practice. That's why there's a category of software called Organizers or Personal Information Managers (PIMs). Yes, you can get along without one. Little yellow stickies around the edges of the monitor can replace some of the functions, and a calendar and Rolodex can manage the others, more or less. But you've got a computer that's already running some parts of your business. You might as well let it run your life.

A good information manager should be able to handle the kinds of information you need to track, and it shouldn't make you jump through hoops to put data in or to get it out again. After all, the PIM is supposed to make your life easier. Ideally, the PIM will take the place of all those random scraps of paper that held lists and phone numbers and notes and reminders. It also will replace your pocket calendar, or at least work with it. Most PIMs can print out calendar pages in formats with which you're already familiar, such as DayTimer, Day Runner, or FiloFax. When you're at your computer, the PIM should be able to remind you of upcoming appointments with a discreet message and a beep. It should be able to open contact information and possibly even dial the phone for you. It should be able to generate a fax to anyone on your contact list, and, assuming you have a fax/modem installed, it should be able to send the fax for you without making you go into some other program to write the message or create the document.

There are two functions that an organizer *must* have: a calendar and a database for addresses and phone numbers. These can be combined into one program, as they are in ClarisOrganizer, Espresso from Berkeley Systems, Day-Timer Organizer, and ACT! to name some of the many available PIMs. They also can be linked from separate programs, the approach taken by Now Software's Now Up-to-Date and Now Contact. Oddly enough, the Now programs may be a much better choice for most people and businesses than the combined PIMs.

Now Up-to-Date gives you the option of several different, and customizable, calendar views and layouts and an optional to-do list. (The list function should be turned off unless absolutely needed, because it seems to take a very long time to draw on-screen.) Up-to-Date enables you to schedule appointments and to-do items as well as phone calls, meetings, and holidays. You can add a list of undated to-do items, checking them off as you accomplish them. You also can designate special days, which identify the whole day rather than a specific event. You can create banners that extend over a period of several days and, in the current version, can also extend over a weekend, something previously impossible in a calendar program. Every scheduled item can be assigned to a category—personal, business, family, or whatever other categories you choose to apply. Now Up-to-Date can display a calendar with only the personal items, or the business items, or whatever combination you need. It filters your entries by category and displays only the ones you want to see at the moment. You can even brighten up your calendar with clip art symbols. Have to make phone calls? Remind yourself with a telephone icon, and link the event to Now Contact. It even dials the number for you. Figure 20.16 shows a typical Now Up-to-Date calendar page.



Figure 20.16

Notice the wrap around banner. No other program can do that!

Now Contact keeps the addresses, phone numbers, and other information about your business contacts, vendors, clients, family, and friends in one easily accessible file. You can keep the most commonly used numbers in a pull-down menu, accessible from the menu bar. Selecting a number opens its contact information, and clicking the phone icon automatically dials the number through your modem. Now Contact has a built-in word processor that enables you to send a fax or a letter to anyone on your list. It can even do a mail merge and send the same letter to as many of your contacts as you want.

ClarisOrganizer isn't as powerful as the Now combination, but it's fast, simple, inexpensive, and extremely easy to learn. Its contact pages and calendar pages look like Now's, without the extra bells and whistles. It doesn't add icons or banners, but manages your appointments and addresses every bit as well. Adding an appointment is even easier here. Just click the calendar to open a dialog box in which you can enter the information and select a category for the entry. If it's a recurring appointment, like the one in Figure 20.17, click the check boxes for the day(s) of the week on which it occurs.

ClarisOrganizer has a floating button palette that accesses the contact manager, calendar, tasks, and notes modules. It is a single-user product. It can't be opened and shared by several users at once, as can Now Up-to-Date, but in the single person business, that's not a handicap. More of a handicap is the lack of menu bar access to the program. If you use Now Menus, you can add it to one of your pull-down or pop-up menus and create a hot key for it.

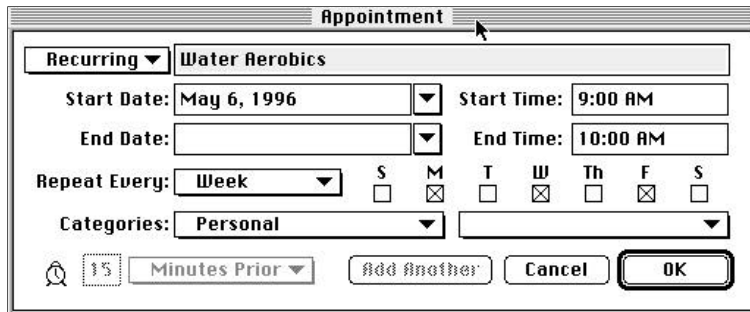

Figure 20.17

Claris Organizer can put your exercise class or other scheduled event on the calendar. Now there's no excuse to skip your workout.

Berkeley Systems' Espresso and StarTrek: The Next Generation's StarDate are funky and fun, but not especially practical or powerful. Their main claim to fame consists of placing a calendar on your desktop, visible in the background while you're doing other things. It can be toggled on and off by clicking an icon on the menu bar. The calendar is easy enough to use and enables you to place banners across several days, although not over a weekend. It supports repeating events and can remind you with an alarm about upcoming appointments. The contact manager simulates a rotary card file, with limited space for information and non-customizable cards. Both Espresso and StarTrek run on the same "engine," the main difference being the graphics treatment. The StarTrek Calendar, as you'd expect, has scenes from the TV series. Dedicated Trekkies would probably be willing to put up with the program's lack of features in return for having their desktops look like the bridge of the Enterprise, but it doesn't do much for the rest of us. Espresso offers a selection of some 20 other graphics treatments for your calendar and contacts. Again, you sacrifice features for pretty pictures. You also sacrifice 2MB of RAM to keep the program running. Not a good deal, all things considered...

Visionary Software's First Things First Organizer/Personal Information Manager isn't the easiest one to use, but it's extremely powerful and optimized for the Power Mac. It combines a calendar—daily, weekly, monthly, or yearly—with a very good outliner, and a floating clock/calendar page that also can be anchored to the menu bar. Use the outliner to develop your goals and plans. Use the outline's hierarchy to decide what's most important, and then add the subset of things to do to reach the goal. When you're ready to set a time to accomplish specific tasks, drag them to the calendar. Set dates and times for meetings, appointments, and reminders.

FTF's calendar can do as much as any other calendar can to keep you on a schedule. It reminds you of appointments with a burst of music, unless you prefer to have it use one of your less obtrusive system sounds. You also can use voice annotations on the calendar if you have a microphone.

The First Things First toolbar toggles back and forth between the outline and calendar views and gives you quick access to the linking and sharing features. It can print your calendar in any of the standard formats, including FiloFax, Day-Timer, Day Runner, and Franklin Planner, as well as on standard sheets of paper. It prints your outlines in any format you want, with or without hidden items, or only text you've selected.

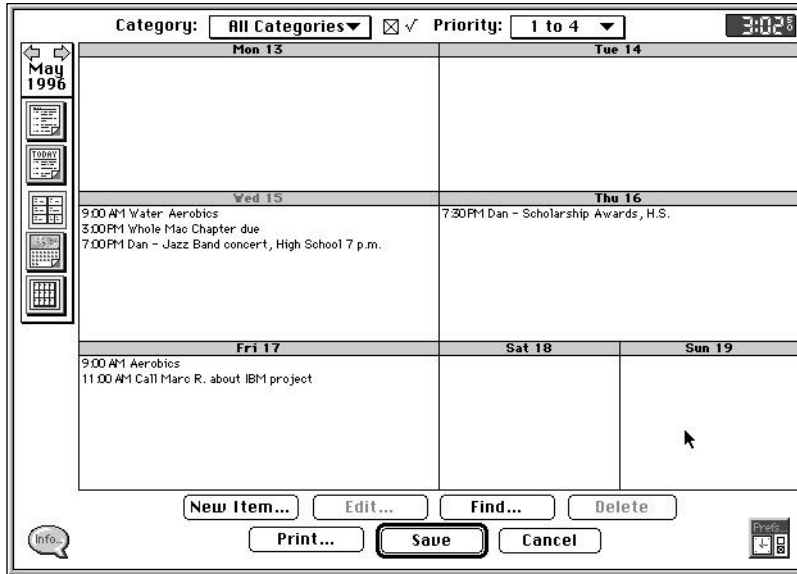

Figure 20.18
View the calendar by the day, week, or month.

First Things First is available as a demo program from online services and bulletin boards. The demo can be upgraded to a full working version by calling the publisher, Visionary Software, with your credit card in hand and buying a registration number. It's an ecologically sane way to distribute software. There's no wasted packaging. The program includes excellent help files, so that you have no real need for a printed manual. Best of all, you can try the software for a month before you buy it. There's a limit to the number of items you can place on the calendar in the demo version, but you can still get a good feel for the program.

Putting on a Good Show

It may have been desktop publishing that put the Mac in business, but it's desktop presentation that put the Mac in Show Biz. Thanks to presentation software it's easy to turn your Mac into a slide projector or video player. Why would you want to? It's a good way to show off your work, for one reason. Turning some of your favorite graphics images into a slide show on your PowerBook is much easier than carrying around a heavy portfolio. You can add text slides that explain the job and detail the cost. Let the presentation make your sales pitch for you. You'll probably find, as many artists and designers already have, that putting together a desktop presentation is less expensive and more effective than hiring a salesman or agent. You can either send the "show" out as a disk or CD-ROM to prospective clients or load it into your PowerBook and take it with you when you go to make a new business pitch.

Ratings

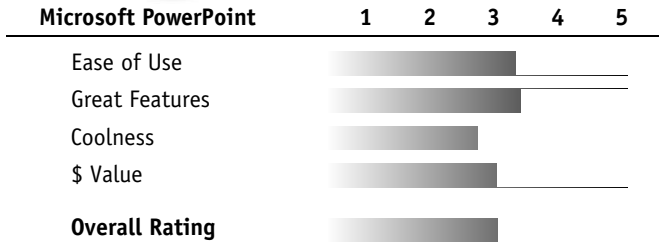

There are two kinds of presentation software for business use. The traditional method for displaying business graphics is still essentially a slide show, although it may incorporate QuickTime movie clips and sounds. Adobe Persuasion, ClarisImpact, and Microsoft PowerPoint are traditional presentation programs, designed to produce programs of slides full of charts, bulleted lists, and clip art graphics. Of course, quite a few other programs also can handle at least a limited form of slide show, including DeltaGraph Pro, Excel, and even KidPix. The nontraditional way is to use a multimedia program, such as Passport Producer, Macromedia Director, or Gold Disk Astound.

Ratings

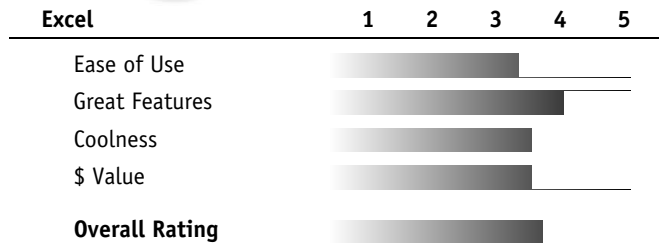

The differences between the traditional and nontraditional are significant. Traditionally, you would plan your speech by starting with an outline. Persuasion and PowerPoint both include outliners with robust text-handling features. PowerPoint's outliner is shown in Figure 20.19.

Ratings

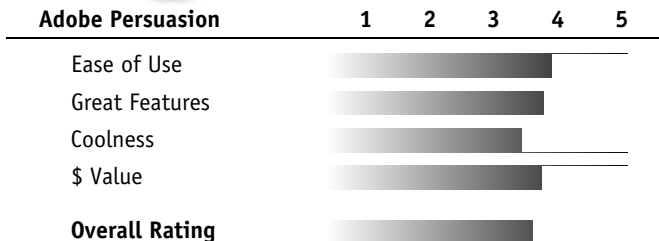



Figure 20.19
PowerPoint's Wizard starts with a basic outline for a sales presentation.

Begin by entering the main topics of your speech, and below them enter the subtopics and points you want to make. Each topic becomes a slide. Formatting the slides is simple, especially if you're willing to accept one of the templates. Select one and then view your slides in that format. If it's not quite what you had in mind, try a different one. Typical presentation programs give you a variety of traditional, modern, and casual looks.



Figure 20.20
This is one of PowerPoint's pre-designed slide formats. You can change the lettering style and the color scheme very easily.

If you can't find one that suits your message, use the tools provided to create your own. Start with a colored background and a readable font. Add a graphic, perhaps a company logo or a symbol. A bar in a contrasting color helps direct the reader's eye to the type. Keep the same master layout for

all of your slides. Switching colors or layouts from one slide to the next distracts the viewer from your message. Stick to 8-bit color, if possible, because it processes faster, and there won't be a delay between slides. If you are running the presentation on someone else's Mac, stick to common fonts, such as Helvetica. Otherwise, you run the risk of the slides appearing in some illegible font that has been substituted for your own favorite custom typeface. Avoid using too many special effects, animated transitions, and so on. Aside from distracting the audience, they slow the Mac to the point where your show becomes jerky and might even crash. Presentation programs, such as PowerPoint, can do a good deal more for you than just putting slides on a screen. If you're giving a speech, take advantage of the outliner, not just to organize your slides and your thoughts, but to create a neatly printed set of speaker's notes. You can even use the program to make the slides into audience handouts containing thumbnails of the visuals and explanatory text.

Microsoft PowerPoint can be purchased alone or as part of the Microsoft Office package. It includes a run-time viewer that can be distributed with your program, so that others may view it without installing the whole application. It has the major advantage of seamless integration with both Macintosh and Windows versions of the other Office suite components.

Gold Disk's Astound falls somewhere between a traditional desktop presentation program and a full multimedia production package. Like PowerPoint, it supports outlining and creates overheads and speaker's notes. It also has some fairly sophisticated animation tools, such as a timeline and a sound editor. Astound has a steeper learning curve than PowerPoint, but after you've figured out how to use it, Astound can do much more. The program ships on five 1.4MB diskettes and a CD-ROM that includes templates and clip media. It's accelerated for Power Mac but runs on any Macintosh using System 7.1 or higher. Astound presentations can include any combination of text, graphics, QuickTime movies, and sounds. These can be imported from AIFF, SND, and WAV sound files, JPEG, TIFF, PICT, EPS, BMP, PCX, TGA, and PhotoCD graphics files, and PICs animation. You can also add *actors*, clips of animation supplied with the program, to liven up your presentations. There are 19 animated actors in the program's file and an additional 155 on the CD-ROM. Each text block, graphic, actor, or movie can be made to appear or disappear from the screen using any of 30 transitional effects, including reveal, dissolve, and fade. Actors also can follow a designated path across the screen. Your slides can contain interactive buttons that play sounds or movies, or enable you to jump between slides, open other presentations, or even launch applications.

Astound's Templates

The templates supplied with Astound can be customized to suit your needs, using the tool palette and menu commands. Astound's publisher hired some very good designers to create the backgrounds and layouts. They're much more interesting than the ones supplied with PowerPoint. There's even a texture generator, so that you can create custom backgrounds and fills, and an Extrude function that automatically converts any two dimensional shape into a three dimensional one. Morphing one object into another can be effective, and Astound's Tween command does it automatically. You need only select the two (draw) objects and specify the number of intermediate steps in the transition. You can even specify a color fill for the shapes, and the background and foreground colors will adjust as one object transitions into the other.

Although traditional presentation programs incorporate some sound effects or music, they expect you to do the talking. Multimedia programs, however, generally can stand on their own. They use more sound, more animation, more QuickTime clips, and inevitably more memory. Many are interactive, making them good choices for kiosk displays, as well as training materials or overviews of new products or services. The viewer can choose what to look at next or follow a branching path through the information. Still, the typical multimedia program doesn't require a degree from film school to operate. Some are based on the familiar outline model. Others use a simple timeline, enabling you to control the duration of events on-screen. You might make the company logo bounce in and jump around for five seconds with some bouncy music to grab the audience's attention, and then dissolve to a title slide, which is followed by a graph that grows as the narrator talks about the expanding market for your new product, which pops in...and so on.

More complicated or seriously interactive multimedia shows might require an authoring program, such as Macromedia Director or even HyperCard. They're more difficult to work with, but enable you to insert many interactive options for the viewer.

ClarisImpact is not so much a presentation program as it is a complete business graphics program. It can, indeed, create slide presentations on the Mac, as 35mm slides, or overhead transparencies. It also can create reports, drawings, outlines, and easily can incorporate timelines, tables, calendars, data charts, organization charts, and flowcharts into any of these.

Impact can handle most, if not all, of your desktop publishing chores, with some help from a good word processor. Impact contains a spelling dictionary and thesaurus, but serious writers might prefer to create large blocks of text elsewhere and then import them into Impact text frames. The drawing tools are essentially the same ones provided with Claris MacDraw Pro or ClarisWorks and are easy to use and intuitive. They enable you to use special effects, such as drop shadows, proportional re-sizing, and more.

ClarisImpact's style selections, although limited, are an especially good feature of the application. They're shared by all of the business graphics tools so that your presentations and other printed matter prepared with ClarisImpact have the same look. The calendar has the same color scheme, fonts, and design elements as the brochure and desktop presentation slides. It gives your work that professional touch.

Other Helpers

If you're like most of us, you would rather spend your software money on new fonts, Photoshop plug-ins, or similar goodies that are fun to play with and will probably make money for you. That's only natural. But there are a few items that could help your business run more efficiently. You might want to consider adding a few of these to your shopping list.

When Your Shipping Comes In...

The first is a real bargain—it's free! If you ship anything via Federal Express, call 1-800-238-5355 and ask for their shipping software for Macintosh. (Of course, you'll need a modem.) It's easy to use, and can save you a lot of time and effort. When you want to send a package, open the program and enter the client's name. The first time you send anything to a client, you'll have to enter the address and other information. After the data's been entered, the shipping program can look it up in its own database.

The program prints an official FedEx shipping label, complete with the correct bar code for routing the package, on plain paper on your laser or inkjet printer. Then it will automatically dial the FedEx computer, enter the package information and request a pick up. The following day, you can have the program call the host computer again and find out exactly when the package was delivered, and even who signed for it. If a package goes astray, the software can trace it for you. You have a reliable record of everything you shipped, in case there's a billing question. As of this writing, Federal Express is the only shipper providing this service, but it's reasonable to expect that others will offer it if there's enough demand. By the way, if you're *not* a regular Federal Express customer, but are expecting a package that hasn't arrived, you also can trace it through Federal Express's Web site, or through their online office on America Online.

Number, Please...

Directory assistance can become expensive if you're looking up out-of-state numbers. You have to know what city and state to ask for, the correct name of the business or person you're trying to find, and often the address. If you know all that, you probably already know the number. But suppose you want to locate all the pet stores in the 617 area, or all the TV stations in Minnesota, or businesses in Rhode Island with "Village" in their name. With old-fashioned phone books, it could take weeks. There's an easier way. Both Select Phone and PhoneDisc publish CD-ROM directories of home and business listings, searchable by any criteria you want to apply. Define the limits to apply to your search, and the program does the sorting for you. The figure shows how PhoneDisc defines a search.

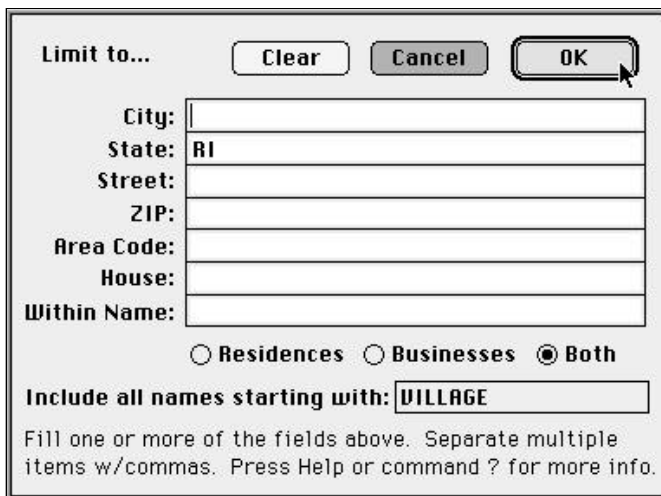

Limit to...

City:

State: RI

Street:

ZIP:

Area Code:

House:

Within Name:

Residences Businesses Both

Include all names starting with:

Fill one or more of the fields above. Separate multiple items w/commas. Press Help or command ? for more info.

Figure 20.21

The business was "Village something..." and it was somewhere in the state.

Select Phone's offerings include a directory of 200,000 fax listings, AT&T's Toll Free 800 Directory, 15 million businesses—sold separately—and the Deluxe edition with more than 95 million home and business numbers. The PhoneDisc PowerFinder claims more than 100 million business and residential listings in a single package. The Select Phone deluxe package has a street price of about \$150, whereas the PhoneDisc CD-ROM sells for just under \$100.

Paper Goods and Goodies

You've probably heard about PaperDirect as *the* source for all kinds of beautiful specialty papers at affordable prices. If you don't have their sample kit, you're missing a great deal. It's a big box with useable samples of every kind of paper and envelope they sell. When you need to send a really important letter on fancy paper to impress a potential client, or when you need a couple of sheets of something special for a project, this is the place to find it. The sample kit includes 140 or more of their most popular papers, envelopes, business cards, and preprinted brochure papers, all for \$24.95. To get one, and a catalog of their full line, call 1-800-A-PAPERS.

Ergonomics

It's hard to be creative when you hurt. You've probably heard all about repetitive stress injuries, such as Carpal Tunnel Syndrome. You may already be using wrist rests, back supports, and an ergonomically designed keyboard and desk. But the best thing you can do for yourself to avoid injury is to take frequent breaks. Get up and walk around. Stretch. Focus your eyes on something far away. If you find that you forget to do these things, consider Visionary Software's LifeGuard, shown here.

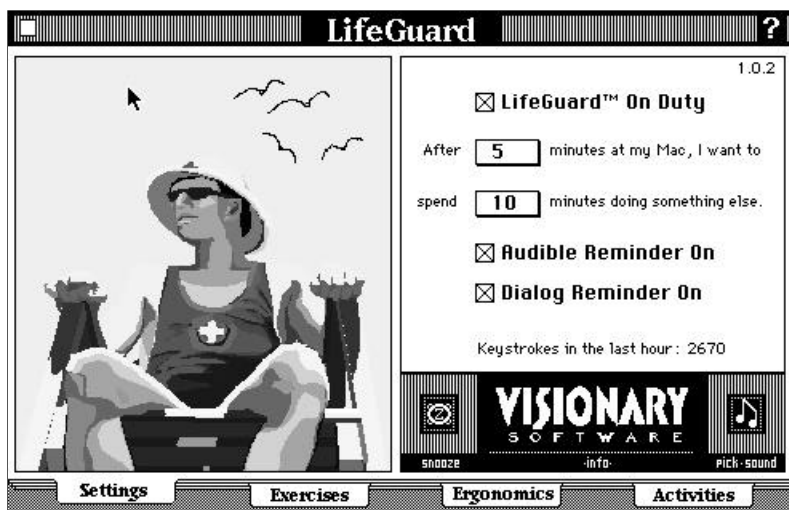

Figure 20.22
Decide how long you want to work and tell LifeGuard when to remind you.

It reminds you to take breaks at specified intervals, and suggests exercises to relieve strain and ways to reposition your work area and yourself to avoid injury. Like other Visionary products, it's available online in demo form and can be upgraded with a phone call.

Summation

Running your own business can be a nerve-wracking experience. It also can be fun, as well as financially rewarding. Much of the nervousness that most new business owners feel is simply the result of trying to do something for which they weren't trained. Art schools don't teach you to balance a checkbook, or to draft a business proposal. But unless you're a very recent graduate, they didn't teach you to draw with a mouse either. There are lots of sources for help. User groups and online forums have experts who can help you with software questions. SCORE (The Service Corps of Retired Executives) has people who have had experience in all kinds of businesses. The Small Business Administration is a government agency that offers training and education programs, counseling services, financial programs, and contract assistance to all sorts of small businesses. And last, but not least, the Internal Revenue Service has year-round help for business-related tax questions.

Copyright (C) Microsoft Corp. 1986-1993. All rights reserved.
Drive F: = Driver CDR0M\$\$\$ unit 0
475936 bytes free memory
0 bytes expanded memory
129 bytes CODE
211 bytes static DATA
2374 bytes dynamic DATA
40336 bytes used

21

Living In A Non-Mac World

Type WIN and press RETURN to start Windows.
C:\>win

In an ideal world, everyone would have a Macintosh. Unfortunately, we live instead in a real world made complicated by multiple PC platforms. Sometimes you'll need to work with art or text that's been created on a PC. On other occasions, you may need to send your work to a PC. You might find a situation in which you need to create a desktop presentation on your Mac that will run on your client's Windows machine. You might find yourself, and your laptop, at the client's office needing to print some pages on his non-Mac printer. Can you do these things? Of course you can.

There are a number of utilities that can help your Mac speak "foreign" languages, like Windows. System 7.5 includes PC Exchange, a control panel that enables you to read and write diskettes in either DOS or Apple II ProDos format. DOS Mounter and Access PC are commercial programs that serve the same purpose for those who may not have upgraded to System 7.5. These programs, however, merely give you access to the disks. You still need a program that can open the file and use it. Many programs, including ClarisWorks and most word processors will open and save files in DOS or Windows formats. Among graphics programs, Photoshop and PageMaker can easily swap documents with their Windows twins. Others may require you to save your work in a "generic" format such as a TIFF or JPEG file.

If you want to know...

Go to...

Can I run Windows on a Mac?	517
Are text files all the same?	516
Can I use my Mac peripherals on my PC?	521
What are my hardware options for cross-platform issues?	519
How can I make certain that everyone can read my files?	517
Can I use my modem to transfer files?	514
What purpose do file extensions serve?	512

Ratings



Getting There Is Half the Fun?

The most obvious problem you'll have to face involves transporting files from a Mac to a DOS/Windows machine or conversely, getting DOS or Windows files onto the Mac. There are a number of ways to accomplish this. The easiest way is to put the stuff you need to transport onto a diskette

What's an Extension?

One of the nice features of the Mac is that you can name your files anything you please. In the DOS world, file names are limited to eight characters plus a three character extension, such as CONTRACT.DOC. The extension is a code that tells the computer what kind of file it is and what kind of program can open it. On a Mac, all documents have an invisible file-signature code embedded in the file, which serves the same purpose. Because DOS/Windows files don't have the signature code, PC Exchange and similar utilities use a system called extension mapping, which associates the DOS extension with a Mac program that can open the file. You can use Macintosh PC Exchange to determine which of your word processor or graphics programs you want to use to open a particular file. Open the control panel and click Add to open a dialog box that permits you to assign a specific application to any useable extension. A few DOS extensions, noted below, indicate programs that will not run on a Macintosh without the addition of a utility, such as SoftPC or a PC coprocessor card.

Some common DOS extensions are:

- .BAT Executable DOS program (cannot be used on a Macintosh)
- .BMP Windows Bitmap graphic
- .CDR CorelDRAW! graphic
- .CGM Computer Graphics Metafile graphic
- .COM Executable DOS file (cannot be used on a Macintosh)
- .CWK ClarisWorks document
- .DIF Data Interchange Format (used by spreadsheet and database programs)
- .DOC Microsoft Word document

and hand it or send it to the other computer user. This kind of file transfer is often called “sneakernet.” You can use the Reebok, Converse, or Nike protocol. (Personally, I’m more comfortable in Birkenstocks.) Long distance, it’s FedexNet. Of course, since you’re sending files to a DOS machine, you will have to send them on a DOS formatted disk. To format a disk for DOS, insert a blank disk in the drive, and select DOS from the pop-up menu in the Erase Disk dialog box, which is found in the Finder’s Special menu. See Figure 21.1. (Note: To do this, you must use a Mac built since 1989. The SE and earlier models can’t read 1.4MB diskettes.)

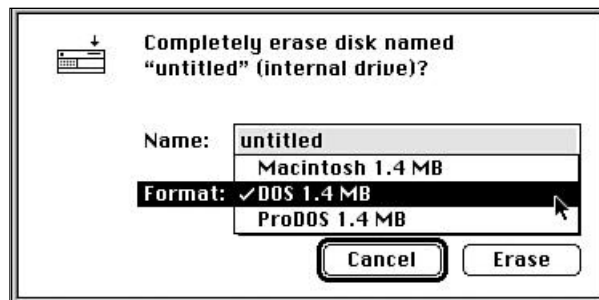

Figure 21.1
Formatting a DOS disk.

- .DWG AutoCAD drawing
- .DXF AutoCAD drawing in exchange format
- .EPS Encapsulated PostScript file
- .EXE Executable DOS file (cannot be used on a Macintosh)
- .PCC PC Paintbrush graphics file
- .PCX PC Paintbrush graphics file
- .PIC Lotus 1-2-3 graphics file
- .PM3 PageMaker 3.0 document
- .PM4 PageMaker 4.0 document
- .PM5 PageMaker 5.0 document
- .PRN DOS 'Print' file
- .RFT DisplayWrite Revisable Form Text (DCA format)
- .STY Microsoft Word style sheet
- .SYL SYLK format (used by spreadsheet and database programs)
- .SYS DOS system file (cannot be used on a Macintosh)
- .TIF TIFF graphics file
- .TXT ASCII text file
- .WMF MicroSoftWindows Metafile
- .WP OfficeWriter or WordPerfect document
- .WPF WordPerfect document
- .WPG WordPerfect graphics file
- .WS WordStar document
- .XY XyWrite document

Suppose you have more data than will fit on a 1.4MB diskette. It happens. Graphics files are large, and PageMaker files of long documents can be huge. Thanks to PC Exchange, your Mac can read and write to files from a DOS or Windows format SCSI device, such as an Iomega Bernoulli or SyQuest cartridge drive or hard drive, as long as the device has less than a gigabyte of storage space. If you don't have one of these available, or if one of the two computers is a PowerBook Duo or a Windows subnotebook with no diskette drive, or even an older PC with only a 5.25 inch diskette drive, there's still a way to transfer the files. If both computers have modems and communications software, you're home free. Obviously, if each computer has its own phone line, just have one call the other and send the files. If it's a long-distance call, sending the files by email is less expensive. Most Internet providers and online services now accept file attachments to email.

If that's not possible, but the two computers are physically close together, you can still use the terminal software to transfer the files. On the PC, the terminal program that comes as part of Windows 3.1 or Windows 95's HyperTerminal will do the job, as will ProComm for DOS. On the Mac side, use any generic telecom program: WhiteKnight, Zterm, FreeTerm, or SITcomm. (Don't use a "dedicated" program like AOL or Prodigy.) Connect the two modems with a standard RJ-11 phone cord, the same one that connects the modem to a wall jack. Start both telecom programs. On one computer, type ATA (for Auto Answer) and immediately, on the other, type ATD (for dial). After handshaking, the two computers should be connected. You might have to try several different combinations of settings. Speeds of 9600 bps or less are most reliable. As soon as you've established a connection, use the communication program's send and receive text commands to exchange text files.

Be sure you have set the same binary file transfer protocol on both machines. The Windows 3.1 telecom software supports Xmodem and Kermit transfers. HyperTerminal adds Zmodem and Ymodem protocols as well. If you are moving a file from the Mac to the PC, turn off MacBinary formatting on the Mac. This is generally done from a Transfer Settings menu or dialog box. Figure 21.2 shows SITcomm's dialog box. If you are sending files from the PC to the Mac, ignore the MacBinary setting.

I am the in-house graphics designer for Rubicon West, a management consulting firm. I primarily work on executive presentations, customized brochures, and Internet sites. I do this in a cross-platform environment.

One of the challenges I've encountered using the Wintel platform is that it doesn't seem to display .eps files very well, especially if they are saved in Macintosh format. (This is not too surprising.) Usually, the name of the file, the date it was created, and the application that created it are displayed as text on-screen. The graphic itself may or may not print.

So, one day I decided that what I needed to do is open the original [FreeHand/Mac] file using FreeHand/Windows and reexport the graphic, so that I wouldn't have to cross platforms. To my surprise, I had the same result placing the new .eps as I described above—a text description of the file. I then went back to the Mac side and reexported the file as an IBM .eps. I replaced the file and it displayed and printed perfectly.

The moral of this story is, if you want to place .eps graphics in some Windows applications, you need to create the graphic on the Mac side and export it from the Mac as an IBM .eps. You can't create it all on the Windows side and have it display correctly. Hmmm.

Diane Kenedy
Rubicon West, Inc.

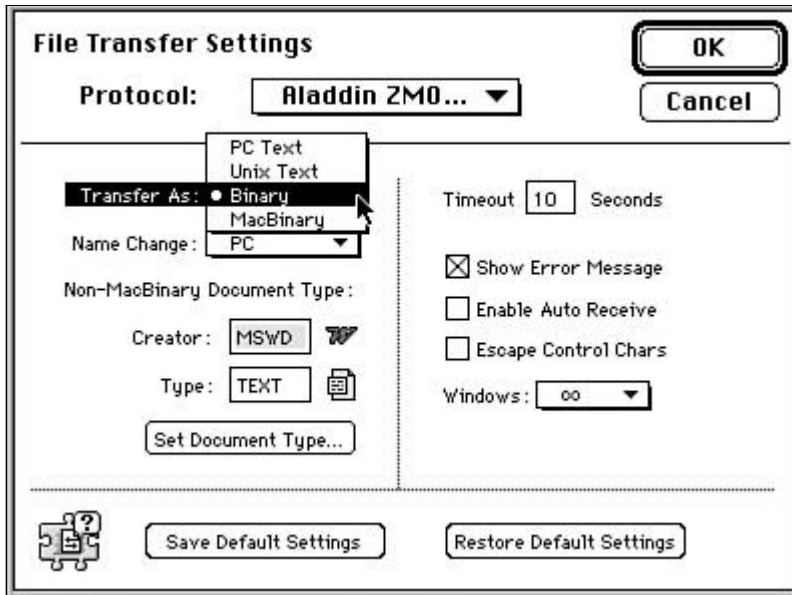

Figure 21.2
*The PC can read straight Binary
 but not MacBinary.*

If the computers don't have modems, you can accomplish the same transfer by using a null modem cable, which you can buy at computer stores. It has a round 8-pin connector on one end and a trapezoidal 9-pin connector on the other end. It connects the Mac's serial port (8-pin) to the COM1 port on the PC. Disable AppleTalk before you attempt a null modem transfer. You'll still need communications software on both computers.

Crossing Platforms Without Getting Clobbered

Getting the file from one computer to the other is only half the battle. You still need to be able to work with it. What's easiest, of course, is to have the same version of the same program installed on both computers. Microsoft Office, which includes Word, Excel, and PowerPoint, interchanges files cross-platform quite nicely, maintaining formatting and matching fonts wherever possible. (When not possible, it invariably chooses the font you'd least like to use. Stick with common ones like Century Schoolbook and Helvetica, and you should be OK.) Quark, Adobe, Claris, and many other software publishers offer compatible programs for both Windows and Mac. If you know what software the non-Mac computer is using, you can often save the file in that format. Check the pop-up menu in the Save As box. You might find a long list of possible formats, as I did in Painter 4.0, shown here in Figure 21.3. If necessary, look for a generic format like TIFF for graphics and RTF for word processing. If you need to deal with transferring spreadsheets or databases, you can usually save them as comma delimited or tab delimited text.

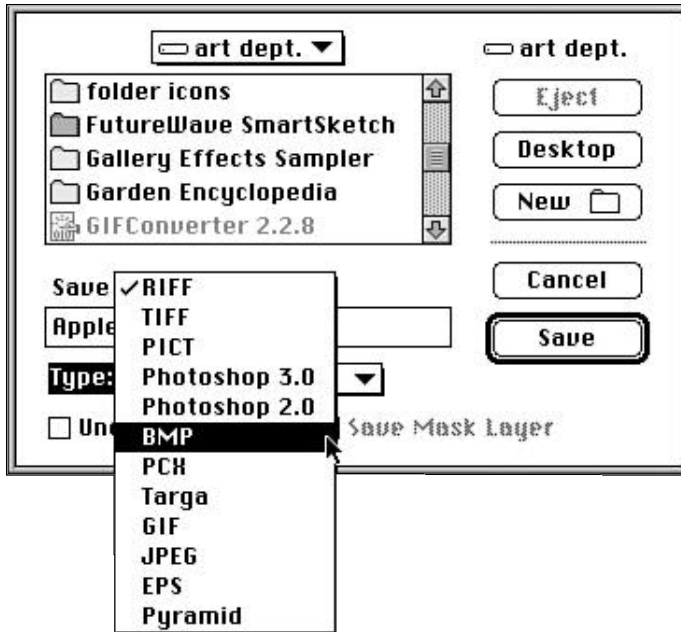



Figure 21.3

Fractal Painter gives you lots of ways to save a file.

If you end up transferring text files from the PC to the Mac, or from the Mac to the PC, there are a couple of little wrinkles of which you need to be aware. The Mac uses a 256-character extended ASCII set, which includes some accents, symbols, and funny little characters that aren't available on the PC. The Apple symbol  is the most common of these, but if you browse with keycaps, you might find the original robot, rabbit, and other goodies Apple's programmers hid on the Mac keyboard. None of these will show up in a DOS or Windows document. They don't exist.

An even more common problem relates to the way the different systems indicate the end of a line of type. Macs use a carriage return, just as you would on an old-fashioned manual typewriter. Remember that arm that stuck out? You'd slap it with your right hand, and it would roll the paper up a line and take you back to the left margin to start your next line. In spite of, or perhaps because of, it being the simple and logical way to perform this task, the PC designers chose a different method. PCs use separate characters for a carriage return and a line feed. The Mac expects to see one character there. Instead, it sees two. So, if you open a text file that was created on a DOS or Windows machine, you'll see a little square box, indicating an unknown character, at the start of each line. That box indicates the unnecessary line feed at the start of each line. If you send a text file from the Mac to a PC, you need to add the line feeds, or else the PC will try to put the whole document on one line. Most Mac word processors will save your text file either as plain text, or as text with line breaks. Choose the latter option if the file is heading for a PC.

If your text file has little boxes, it's often a nuisance to get rid of them. You can do a global search and replace in the word processor, or you can look for an inexpensive shareware application called DOSWasher. You drop the DOS text file on the DOSWasher icon and it becomes a Mac text file, minus line feeds. If you've forgotten to save a Mac text file with line breaks, drop it on DOSWasher, and it magically becomes a DOS file. At only \$5, it's a cheap and easy answer.

When you need to do more than occasional file conversions, it's worthwhile investing in a copy of DataViz translators. More comprehensive than Apple's PC Exchange, the DataViz package includes every possible Mac/PC/Windows translator. (The connection package also includes a cable and communications software for the kind of direct file transfers described previously.) If you're not concerned with translating anything but graphics, consider DeBabelizer, from Equilibrium. DeBabelizer Toolbox does batch conversions and includes editing and palette manipulation tools, whereas DeBabelizer Lite has the same translators without the tools for a much lower price. Both are compatible with Photoshop plug-ins.

The PNG of the Cash Register

The latest word in graphics file formats is PNG, which stands for Portable Network Graphics. CompuServe is introducing the PNG format as a replacement for GIF (Graphic Image Format), which it originally introduced for its subscribers about eight years ago. It seems that a company called Unisys had taken out a patent on some file compression specifications and in all this time hadn't realized that CompuServe was using the same file compression method. CompuServe didn't know about the Unisys patent, until last December when Unisys announced that it would start collecting royalties from everyone who used GIFs.

Can a Mac Do Windows?

A Mac can do anything, including Windows. There are times when you might actually need this capability. Suppose your client wants you to create something in a specific application that only runs in DOS. Or suppose you have an elaborate presentation in Premiere, and you want to make absolutely sure it will run on a Windows machine, but you don't have one to try it on. Perhaps the software you want to use hasn't reached the Mac platform yet. You can turn your Mac into a DOS machine in either of two ways.

The easiest way, and the least expensive, is to get a copy of SoftWindows by Insignia Solutions. It's a program that "emulates" Windows and DOS on your Mac. Costing several hundred dollars less than the alternative hardware solution, it's an acceptable, if somewhat slow, way to solve your cross-platform problems. In order to use it, you need to set aside a reasonable amount of hard drive space, at least 20 to 30MB, to create a PC drive. You also need a decent amount of RAM, since you're running not just one, but two, operating systems, plus whatever application(s) you intend to use.

12MB is almost adequate. 20MB is better. After you install it and start it, you'll see the typical DOS C: prompt, just as is shown in Figure 21.4. Type WIN, and there you are—with a brain-damaged Mac wannabe, instead of the smart computer you know and love.

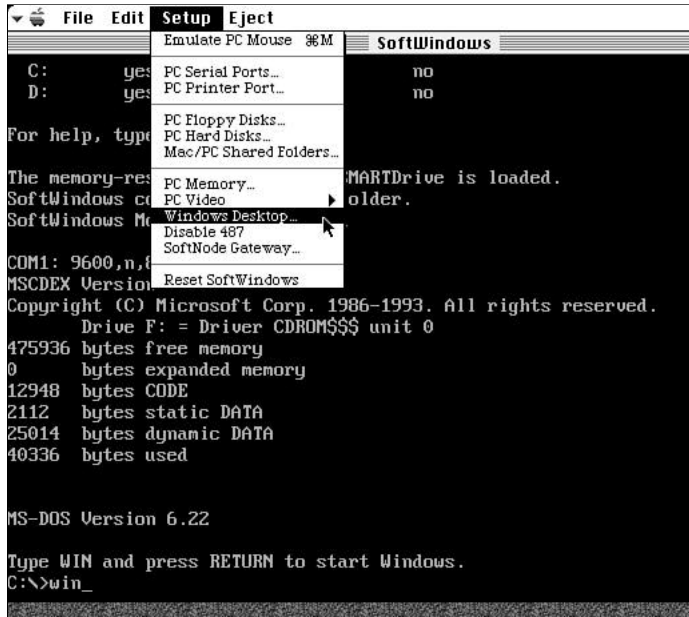

Figure 21.4

Did you ever think you'd see that on a Mac screen?

The only real problem with using SoftWindows is being sure you have the right version. It comes in three flavors, and there's also SoftPC, which enables you to run DOS but not Windows. SoftWindows for Power Mac is the most powerful. Of course, it requires a Power Mac to run. It emulates a 486 PC machine running Windows 3.1 and DOS 6.22. SoftWindows for Macintosh runs on any 030/040 Mac, including Centris, Quadra, LC, and most PowerBooks. It's not as powerful as the Power Mac version. It only emulates the early 286 PC, so it's not going to handle any application that requires a 486 processor. It should be able to handle most 386 programs, albeit very slowly. Both of these emulators include the capability to network with other PCs. SoftWindows provides full MS-DOS and Windows in standard mode, as well as built-in PC network support for Novell NetWare, LAN Manager, Banyan Vines, Windows NT Advanced Server, and TCP/IP. SoftWindows is also compatible with the full range of PC devices and systems, including COM and LPT ports, diskette drives, memory systems, video displays, and CD-ROMs. SoftWindows for Performa is essentially a light version of SoftWindows for Macintosh. It runs the same software, but doesn't have the networking capability. It costs a lot less, too, with a street price of around \$200, as opposed to the Power Mac and Macintosh versions that sell for about one hundred dollars more. SoftWindows for Performa, however, will only run on a Performa.

Ratings

SoftWindows	1	2	3	4	5
Ease of Use					
Great Features					
Coolness					
\$ Value					
Overall Rating					

SoftWindows is fine if you're not in a hurry, but if you need to use Windows frequently or with applications that demand a lot of computing power, consider adding a DOS compatibility card instead. Power Macs, Centris models, and Quadras (except for the 630 and AV models) can accept the plug-in DOS card, which essentially puts a small PC inside your Mac. With a shortcut command, you can switch back and forth between Windows and System 7.x. There are no emulation or compatibility problems. You end up with two computers in the same box, taking turns using the keyboard and screen. The cards include either a Pentium or 586 processor chip, which means that you can run all kinds of Windows applications, even those that require Windows 95. The card also includes Sound Blaster 16 for 16-bit stereo sound support. Obviously, the DOS and Windows programs run faster with the card, but speed isn't cheap. Expect to pay almost as much as you would for an off-brand PC. Cards are currently being made by Apple, Reply Corp., and Orange Micro. Installation is simple and takes only a couple of minutes. The cards plug into either a NuBus or PDI slot, depending on which Mac you're using.

Into the Great Unknown

Going cross-platform isn't difficult if you know where you're going. If you know your client uses Photoshop and Microsoft Word for Windows, you can reasonably expect her to see the words and pictures you've sent in the same form in which you created them—the same colors, the same layout, and the same fonts. Sometimes, however, when you are designing a document to be distributed on the World Wide Web, on a CD-ROM, or over a local network to all the members of a workgroup, you can't check every computer to make sure all have the right software and fonts to look at your carefully formatted report, complete with the tables and graphics you put in and lots of fancy typography. Sending it around as ASCII text certainly won't work. Sending it as a Word file and hoping everyone can figure out how to read it is risky. There's a category of software that solves the problem for you. They're called Electronic Publishers. Some of the most common ones are Adobe Acrobat, No Hands Software's Common Ground, and Envoy, from WordPerfect.

Ratings

Adobe Acrobat	1	2	3	4	5
Ease of Use					
Great Features					
Coolness					
\$ Value					
Overall Rating					

Most of these programs let you send fully formatted pages to any other computer (Mac or Windows) even if the recipient doesn't have the application that created it or the fonts you used. They might need a "viewer" or "reader" program, to open the document, but these are free and distributed everywhere. Acrobat Readers are available for Mac, Windows, DOS, and Unix. There's an Acrobat Viewer on the System 7.5 CD-ROM, and you probably got one or two different viewers with your Internet software or with some other application that used an Acrobat, Envoy, or Common Ground file as a Read Me.

Electronic Publishers work exactly like a printer driver or fax driver. To create an electronic document to share, select the program's driver in the Chooser, and then proceed as if you were going to print it. Adobe Acrobat is perhaps the most common of the Electronic Publishers. It uses several Adobe technologies, including the PostScript language and ATM along with the shrink and stretch capability of multiple master fonts to produce a document that looks exactly as you intended, no matter the computer platform that the viewer is using. Of course, you can print these documents, too, and know that a page printed from your client's Windows machine will look the same as a page printed by your Mac and LaserWriter. Acrobat calls its files PDF files, for Portable Document Format. Built-in compression helps keep the file to a reasonable size. Color and grayscale images are compressed by a factor of 10:1, and text is compressed as much as is feasible. Use of the compression algorithm means, however, that you can't view these documents without the reader, which uncompresses them. The fonts are matched with those on the recipient's machine if possible; otherwise, they're re-created using the Adobe multiple master fonts. Acrobat also shows thumbnails of each page of a multi-page document, making it much easier to find what you are looking for, and lets you annotate your pages with notes, Hypertext links, and bookmarks. Of course, you're going to pay for all this power. The basic package costs \$195, and the pro version will add about \$500 to your credit card bill.

Envoy is another example of an electronic publisher. You can create your document in any application that will print. Use Photoshop, Painter, PageMaker, Word, ClarisWorks, or whatever suits the job. Choose the Envoy driver from the Chooser. When you attempt to print it, Envoy gives you a dialog box (shown in Figure 21.5) that has several options, including saving the document as an Envoy file, launching the Envoy viewer with

your file as the current document, or saving it as a run-time version. The latter choice allows your document to be opened on a Macintosh that doesn't have an Envoy viewer installed. You can also use drag-and-drop to create an Envoy document. Select the closed file, drag it, and drop it on the Envoy viewer icon.

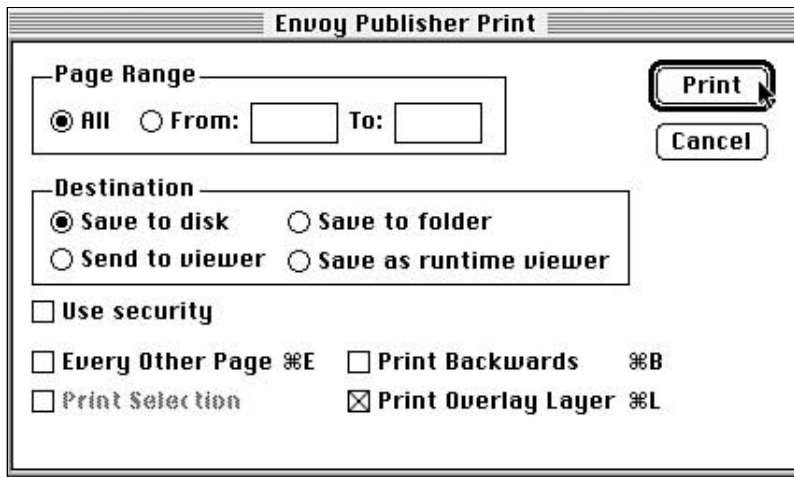

Figure 21.5
Other electronic publishers use a similar print options dialog box.

If you're sending out a desktop presentation or a QuickTime movie, you might need to send the appropriate viewer along with it. Microsoft PowerPoint, Adobe Persuasion, Gold Disk Astound, and other similar programs have Windows players as well as Mac players. These can be distributed freely and can be downloaded from all of the usual sources.

Sharing Our Toys

We all learned in kindergarten, if not earlier, that sharing is good. Macs and PCs haven't really learned that lesson yet. Many of the Mac's "toys," such as the mouse, graphics tablet, and keyboard, attach to the Apple Desktop Bus, a port conspicuously absent on the PC. And many PC goodies plug into a parallel port that is similarly lacking on the Mac. The good news, if you have to use both Mac and PC, is that an increasing number of peripheral devices can speak both languages. Most modems simply need the appropriate cable and software. The contents of the external modem are the same, whether it says Mac or PC on the label. Plug-in cards, of course, are a different matter entirely. Monitors aren't Mac specific anymore. Most of Apple's recent models will support a standard PC monitor (VGA or SVGA), and most manufacturers offer "Multisync" monitors that can accommodate signals from a wide range of PC video cards as well as Mac CPUs.

SCSI devices aren't as standard in the PC world as they are among Macs. SCSI isn't typically built into the PC as it is into the Mac, but there are SCSI adapter cards that (with the addition of the appropriate device drivers) will let you use a SCSI hard drive, scanner, or CD-ROM player with a PC.

Printers are the biggest hurdle for sharing. Most PC printers demand a parallel port, whereas Mac printers use a serial port. PowerPrint, from GDT Software, is the answer. The package includes a serial to parallel converter cable, print spooler, and drivers for all of the common PC printers. PowerPrint is a must-have if you travel with a PowerBook and need to print a document while you're at a client's office. Plug in your cable, choose the appropriate driver, and print. It's that easy. If you don't expect to need it right away, wait awhile before you invest in a copy. Many of the newer office printers now have multiple ports so you can plug in the Mac and the PC side by side, and let the printer switch itself back and forth depending on which machine is sending it data. Eventually, all offices will have either this system or a compatible LAN that will enable you to plug in the PowerBook and swap files with PCs. Perhaps the network will be replaced by an infrared beaming device, like the one in the Newton. And eventually Macs and PCs will be able to run the same programs without translation or emulation. Until that day comes, there are plenty of work-arounds.

Summation

When you chose a Mac, you bought the Swiss Army knife of computers. No matter what you want to do, there's a way to accomplish it, whether it's sending a piece of art across the Internet to a Windows-using client; printing a file to a printer you've never seen before; or sending the same electronic newsletter to DOS, Unix, Mac, and Windows users. You might need to use additional software or hardware solutions, but everything you need is readily available as shareware or from your friendly computer store. You might have to live in a non-Mac world, but with your Mac equipped to deal with the realities, the world is your oyster.

Appendix

This Appendix provides a list of software titles and hardware products. The Software section is arranged alphabetically by product name. The hardware section is arranged according to device: printers, scanners, and so on.

This is not a comprehensive list, but it should provide a good basic reference.

Software

ACT!

Symantec
(408) 253-9600
[http://www.symantec.com/lit/
→app/macap/act2mac.html](http://www.symantec.com/lit/app/macap/act2mac.html)

After Effects

Adobe Systems, Inc.
(800) 628-2320
<http://www.adobe.com/>

Alien Skin Software (plug-ins)

(919) 832-4124
<http://www.alienskin.com>

Andromeda Software, Inc.

(plug-ins)
(800) 547-0055
<http://www.andromeda.com>

Astound

Gold Disk
(800) 982-9888
[http://www.golddisk.com/
→astound.html](http://www.golddisk.com/astound.html)

Batch It!

Gryphon Software Corporation
(619) 536-8815
<http://www.gryphonsw.com>

Canvas

(305) 596-5644
[http://www.deneba.com/dsi_root/
→prodinfo/prodinfo.html](http://www.deneba.com/dsi_root/prodinfo/prodinfo.html)

ClarisImpact

ClarisWorks
(800) 544-8554 ext. 311
[http://www.claris.com/products/
→ClarisImpact/index.html](http://www.claris.com/products/ClarisImpact/index.html)

ClarisOrganizer

ClarisWorks
(800) 544-8554 ext. 311
[http://www.claris.com/products/
→ClarisOrganizer/index.html](http://www.claris.com/products/ClarisOrganizer/index.html)

ClarisWorks

(800) 544-8554 ext. 311
[http://www.claris.com/products/
→ClarisWorks/index.html](http://www.claris.com/products/ClarisWorks/index.html)

Collage

Specular
(800) 433-SPEC
<http://www.specular.com>

CorelDRAW!

(800) 772-6735
[http://www.corel.com/products/
→graphics&publishing/index.htm](http://www.corel.com/products/graphics&publishing/index.htm)

Day-Timer Technologies

Day-Timer Organizer, Version 2.0
(310) 843-0800
[http://www.mobileoffice.com/
→best/kwikspinz/qs_daytimer.html](http://www.mobileoffice.com/best/kwikspinz/qs_daytimer.html)

DeltaGraph Pro

(800) 446-6955
[http://delta.deltapoint.com/
→dgpro/](http://delta.deltapoint.com/dgpro/)

Director

Macromedia Inc.
(800) 597-2468
[http://www.macromedia.com/
→Tools/Studios/DMS/index.html](http://www.macromedia.com/Tools/Studios/DMS/index.html)

ElectricImage

(818) 577-1627
<http://www.electricimg.com/>

Excel

Microsoft
[http://www.microsoft.com/
→macoffice/ProductInfo/pi_xl_
→mac.htm](http://www.microsoft.com/macoffice/ProductInfo/pi_xl_mac.htm)

Expresso

Berkeley Systems
(800) 713-7146 ext. 333
[http://www.berksys.com/www/
→products/expresso.html](http://www.berksys.com/www/products/expresso.html)

**Final Effects AP for Adobe
Premiere**

MetaTools Software
(805) 566-6200
<http://www.metatools.com>

First Things First Software

(503) 246-6200
[http://www.macfaq.com/
→vendor/software/1151.html](http://www.macfaq.com/vendor/software/1151.html)

Fontographer

Macromedia
(800) 597-2468
<http://www.macromedia.com>

form•Z

(614) 488-8838
<http://www.formz.com>

Fractal Design Painter

(408) 688-8800
[http://www.fractal.com/
→p4preview/](http://www.fractal.com/p4preview/)

FreeHand

Macromedia
(800) 597-2468
<http://www.macromedia.com>

Gallery Effects

Adobe Systems, Inc.
(800) 833-6687
<http://www.adobe.com>

Griffin Technology

(615) 255-0990
[http://www.nashville.net/
→~griffin/](http://www.nashville.net/~griffin/)

HoTMetaL Pro

<http://www.sq.com/products>

Illustrator

Adobe Systems, Inc.
(800) 628-2320
<http://www.adobe.com/>

Infini-D

Specular
(800) 433-SPEC
<http://www.specular.com>

Intellihance

Extensis Corporation
(800) 796-9798
<http://www.extensis.com>

Intuit QuickBooks

(800) 224-0991
[http://www.qfn.com/
→quickbooks/](http://www.qfn.com/quickbooks/)

Kid Pix

Brøderbund Software, Inc.
(800) 521-6263
[http://www.broder.com/studio/
→atoz/kipstcd.html](http://www.broder.com/studio/atoz/kipstcd.html)

KPT 3.0

MetaTools Software
(805) 566-6200
<http://www.metatools.com>

KPT Convolver

MetaTools Software
(805) 566-6200
<http://www.metatools.com>

KPT Vector Effects for Illustrator and FreeHand

MetaTools Software
(805) 566-6200
<http://www.metatools.com>

Logomotion

Specular
(800) 433-SPEC
<http://www.specular.com>

M.Y.O.B.

Best!Ware
(201) 586-2200
<http://www.bestprograms.com/>
→[website/myob.html](http://www.bestprograms.com/website/myob.html)

Nisus Writer

<http://www.nisus-soft.com/>
→[product_info.html#NisusWriter](http://www.nisus-soft.com/product_info.html#NisusWriter)

Now Software, Inc.

Up-To-Date
(503) 274-2800
<http://www.nowsoft.com/>

PageMaker

Adobe Systems, Inc.
(800) 628-2320
<http://www.adobe.com/>

PageMill

Adobe Systems, Inc.
(800) 628-2320
<http://www.adobe.com/>

Paint Alchemy

Xaos Tools
(415) 487-7000
<http://www.xaostools.com>

PaperDirect

(800) A-PAPERS

Peachtree Accounting

(800) 247-3224
<http://www.peach.com/>
→[l2pam.html](http://www.peach.com/l2pam.html)

Persuasion

Adobe Systems, Inc.
(800) 628-2320
<http://www.adobe.com/>
→[prodindex/persuasion/main.html](http://www.adobe.com/prodindex/persuasion/main.html)

Photoshop

Adobe Systems, Inc.
(800) 628-2320
<http://www.adobe.com/>

PowerPoint

Microsoft
<http://www.microsoft.com>

Premiere

Adobe Systems, Inc.
(800) 628-2320
<http://www.adobe.com/>

QuarkXPress

(303) 894-8888
<http://www.quark.com>

SiteMill

Adobe Systems, Inc.
(800) 628-2320
<http://www.adobe.com/>

**Star Trek: The Next Generation®
StarDate™ Calendar and Address
Book**

Berkeley Systems
(800) 713-7146 ext. 333
<http://www.berksys.com/www/>
→[products/expresso.html](http://www.berksys.com/products/expresso.html)

Terazzo

Xaos Tools
 (415) 487-7000
<http://www.xaostools.com>

Text Wizard (plug-in)

Cinetic GmbH
 Karlsruhe, Germany
 49 721 94329-0

Word

Microsoft
<http://www.microsoft.com/>

WordPerfect

(800) 772-6735
<http://www.corel.com/>
 ↪[products/wordperfect/index.htm](http://www.corel.com/products/wordperfect/index.htm)

Write Now

Softkey
 (423) 670-2020
<http://www.softkey.com/html3/>
 ↪[catalog/7.html](http://www.softkey.com/html3/catalog/7.html)

xRes

Macromedia
 (800) 597-2468
<http://www.macromedia.com>

Plug-Ins

Alien Skin Software

(919) 832-4124
<http://www.alienskin.com>

Andromeda Software, Inc.

(plug-ins)
 (800) 547-0055
<http://www.andromeda.com>

Cytopla Software Inc.

(415) 364-4594
<http://www.cytopia.com>

Digital Frontiers

(847) 328-0880
<http://www2.interaccess.com/>
 ↪[dfrontiers/](http://www2.interaccess.com/dfrontiers/)

Eastman Kodak Company

(800) CD-KODAK
<http://www.kodak.com>

Extensis Corporation

(800) 796-9798
<http://www.extensis.com>

Flamingo Bay/imageXpress

(770) 564-9924
<http://www.gracenet.com/>
 ↪[scanprep](http://www.gracenet.com/scanprep)

Gallery Effects

Adobe Systems, Inc.
 (800) 833-6687
<http://www.adobe.com>

Gryphon Software Corporation

(619) 536-8815
<http://www.gryphonsw.com>

HighWater Designs

(603) 669-7466
<http://www.highwater.com/>
 ↪[fbi.htm](http://www.highwater.com/fbi.htm)

Knoll Software

(415) 453-2471

Lowly Apprentice Production, A

(619) 438-5790

MetaTools Software

(805) 566-6200
<http://www.metatools.com>

MicroFrontier

(515) 270-8109
<http://www.microfrontier.com/>

Second Glance

(360) 692-3694

Text Wizard (plug-in)

Karlsruhe, Germany
 49 721 94329-0

Total Integration, Inc.

(847) 776-2377
<http://www.totalint.com>

Xaos Tools

(415) 487-7000
<http://www.xaostools.com>

Hardware

Adapters and Cards

Apple
(800) 767-2775
<http://www.apple.com>

ATI
(905) 882-2600

Colortron
(800) 994-2656

Diamond
(800) 468-5846

Matrox Graphics
(800) 361-1408

Number Nine
(800) 438-6463

Radius
(800) 227-2795

Input Devices

Kinesis Corporation
(800) 454-6374
(206) 402-8100

Silicon Valley Bus Company
(800) 775-0555
(408) 623-2300

Mouse

Logitech
(510) 795-8500
<http://www.logitech.com/>

Trackpads

Alps Electric (USA) Inc.
(408) 432-6000
(800) 825-2577
<http://www.alpsusa.com>

Cirque Corp
(801) 467-1100
(800) 454-3375

MicroQue Inc.
(801) 263-1883
<http://www.maclinq.com/>
↳ [microque](http://www.maclinq.com/microque)

Touché Technologies Inc.
(415) 331-6622
(800) 223-6433
<http://www.intltech.com/touche>

Monitors

Acer
(800) 368-2237
<http://www.acer.com>

Addonics
(800) 787-8580

ADI
(408) 944-0100

Amdek
(800) 722-6335

AOC
(800) 343-5777

Apple
(800) 767-2775
<http://www.apple.com>

Arche
(800) 437-1688

ArtMedia
(408) 980-8988

AST

(800) 876-4278

<http://WWW.ast.com/>↪[americas/monitors.htm](http://WWW.ast.com/americas/monitors.htm)**Aydin Controls**

(215) 542-7800

Barco

(404) 590-7900

CalComp

(800) 225-2667

CD Solutions

(510) 820-5400

Compaq

(800) 946-9545

<http://www.compaq.com>**Conrac**

(818) 303-0095

Cornerstone

(800) 562-2552

Covid

(602) 966-2221

CTX

(800) 888-9052

Cutting Edge

(307) 789-0582

DEC

(508) 493-5111

Dell

(800) 289-3355

<http://www.dell.com>**Delta Products**

(919) 380-8883

DTI

(801) 226-2984

Ehman

(800) 257-1666

Epson

(800) 289-3776

<http://www.epson.com/>**ETC Computer**

(510) 226-6250

Focus

(800) 538-8865

Fujitsu

(800) 626-4686

<http://www.fujitsu.com/>**Genova**

(310) 538-4102

Goldstar

(201) 816-2000

<http://www.goldstar.com/>**GVC (MaxTech)**

(800) 289-4821

Hardware That Fits

(800) 364-8737

Hewlett-Packard

(415) 857-1501

<http://www.hp.com/>**Hitachi**

(800) 729-2233

<http://www.hitachi.com/>**Hyundai**

(800) 568-0060

IBM

(800) 426-2968

<http://www.ibm.com/>**IDEK (Iiyama)**

(800) 594-7480

Identity Systems

(800) 723-8258

Iicon

(408) 779-7466

Ikegami

(201) 368-9171

Image Systems

(612) 935-1171

Link

(800) 448-5465

MAG

(800) 827-3998

Magnavox

(800) 835-3506

<http://www.magnavox.com/>

Mantech

(703) 913-2400

Megagraphics

(800) 423-0183

Megatron

(714) 777-6166

Micro Display

(800) 328-9524

Microvitec

(404) 991-2246

Mirror

(800) 654-5294

Mitac

(800) 756-9888

Mitsubishi

(714) 220-2500

Mobius

(510) 654-0556

Moniterm

(612) 935-4151

Nanao

(310) 325-5202

NEC

(800) 632-4636

<http://www.nec.com>

Nokia

(415) 331-4244

NSA (Hitachi)

(800) 649-4849

NutMeg

(800) 777-8439

Optiquest

(800) 843-6784

Orchestra

(714) 891-1386

Packard Bell

(818) 865-1555

Panasonic

(800) 742-8086

PCPC

(818) 884-3092

PDS

(619) 222-7900

Phillips

(800) 835-3506

<http://www.phillips.com>

Pixelink

(508) 562-4803

Portrait Display Lab

(510) 227-2700

Presenta

(818) 960-0420

Princeton Graphics

(714) 751-8405

Proxima

(800) 447-7694

Qume

(800) 448-5465

Radius

(800) 227-2795

RasterOps

(800) 729-2656

Relax

(510) 471-6112

Relisys

(800) 783-2333

Sampo

(770) 449-6220

Samsung

(800) 726-7864

Samtron

(800) 726-8766

Sceptre

(800) 788-2878

Seiko

(201) 529-5730

Sharp (LCD)

(800) 237-4277

Sigma Designs

(510) 770-0100

Silicon Graphics

(415) 960-1980

Smile

(800) 876-4532

Sony

(800) 352-7669

Tatung

(800) 829-2850

ViewSonic

(800) 888-8583

Wen

(914) 347-4100

Modems**Apple**

(800) 767-2775

www.apple.info.com**Global Village**

(800) 736-4821

www.globalvillage.com**Hayes**

(770) 441-1617

www.hayes.com**Supra**

(360) 604-1400

www.supra.com**Telebit**

(800) 835-9848

www.telebit.com**US Robotics**

(800) 342-5877

www.usr.com**Printers****Apple**

(800) 767-2775

www.apple.info.com**CalComp**

(800) 932-1212

www.calcomp.com**Digital**

(800) 777-4343

www.digital.com**Epson**

(800) 289-3776

www.epson.com**Fargo**

(800) 327-4622

www.fargo.com**GCC**

(617) 275-5800

<http://www.gcctech.com>**GDT (PC adapters)**

(604) 473-3600

<http://www.gdt.com/>[products.html](http://www.gdt.com/products.html)**General Parametrics**

(800) 223-0999

www.spectrastar.com**Hewlett-Packard**

(800) 752-0900

www.hp.com**Kodak**

(800) 235-6325

www.kodak.com**Lexmark**

(800) 891-0331

www.lexmark.com**NEC**

(800) 632-4636

www.nec.com**NewGen**

(800) 756-0556

www.newgen.com

QMS

(800) 523-2696

www.qms.com**Seiko**

(800) 848-3545

www.cgg.seiko.com**Shinko**

(800) 997-4465

<http://launcher.g-search.or.jp/>↳ JEIDA/www/datashow/e/↳ x064_e.htm**Summagraphics**

(800) 444-3425

www.summagraphics.com**Tektronix**

(800) 835-6100

www.tektronix.com

Scanners

Agfa

(508) 658-5600

www.agfa.com**Apple**

(800) 767-2775

www.apple.com**Epson**

(310) 782-0770

www.epson.com/prod/scanners/↳ index.html**Hewlett-Packard**

(800) 333-1917

<http://www.dmo.hp.com/>↳ peripherals/scanners/main.html**Howtek**

(800) 444-6983

www.howtek.com**Kodak**

(800) 235-6325

<http://www.kodak.com/>↳ digitalImaging/aboutPhotoCD/↳ aboutPCD.shtml**LaCie**

(800) 999-1179

www.lacie.com**Minolta**

(201) 825-4000

www.minolta.com**Nikon**

(800) 526-4566

www.nikon.com**Optronics**

(800) 331-7568

www.intergraph.com/optronics**Polaroid**

(800) 816-2611

www.polaroid.com/products/↳ scanners.htm**Primax**

(800) 774-6291

deskscan@primaxelec.com**Relisys**

(800) 239-0718

www.relisys.com**Scantron (Eurocore)**

(800) 722-8766

www.scantron.com**ScanView**

(415) 378-6360

Screen

(800) 372-7737

Stalker Software

(415) 927-1026

Umax

(800) 562-0311

www.umax.com/scandir2.html

Storage

Apple

(800) 233-4846

www.apple.info.com**APS**

(800) 677-3294

<http://www.apstech.com>**CharisMac (software)**<http://www.charismac.co>**ClubMac**

(800) 258-2622

Dantz (software)

(800) 225-4880

<http://www.dantz.com>**FWB**

(415) 833-4616

<http://www.fwb.com>**IBM**

(800) 426-3333

<http://www.ibm.com>**Iomega**

(800) 697-8833

(408) 324-0640

(801) 778-1000

<http://www.iomega.com>**LaCie**

(800) 999-0499

<http://www.lacie.com>**Maxtor**

(800) 262-9867

<http://www.maxtor.com>**Megadrive**

(310) 247-0006

<http://www.megadrive.com>**microboards**

(611) 488-9800

Micronet

(714) 453-6100

<http://www.micronet.com>**Micropolis**

(800) 395-3748

<http://www.micropolis.com>**Mirror**

(800) 654-5294

<http://www.dtpdirect.com>**MOST**

(800) 233-6104

Nomai

(800) 556-6624

nomaiusa@applelink.apple.com**Olympus**

(800) 347-4027

Optima

(800) 411-4237

<http://www.optimizech.com/>→[optima](#)**Panasonic**

(800) 742-8086

<http://www.panasonic.com>**Philips**

(800) 235-7373

<http://www.philips.com/pkm/las>→[eroptics](#)**Pinnacle**

(800) 553-7070

<http://www.pinnacle.com>**Plasmon**

(800) 445-9400

<http://www.plasmon.com>**PLI**

(800) 288-8754

ProMax

(800) 977-6629

<http://www.scsidisk.com>**Quantum**

(408) 894-4000

<http://www.quantum.com>**Ricoh**

(800) 225-1899

<http://www.ricoh.com>

Seagate

(800) 400-0310

[http://www.seagate.com/stor/
stortop.shtml](http://www.seagate.com/stor/stortop.shtml)

Sony

(800) 352-7669

<http://www.sony.com>

Symantec (software)

(800) 441-7234

[http://www.symantec.com/lit/
util/macut/macut.html](http://www.symantec.com/lit/util/macut/macut.html)

SyQuest

(800) 245-2278

<http://www.syquest.com>

Toray

(800) 867-2973

<http://www.toray.com>

Toshiba

(212) 596-0600

<http://www.toshiba.com>

Yamaha

(800) 543-7457

<http://www.yamaha.com>

Index

Symbols

- 3-Dimensional Animation (software), 432**
- 3D (3-dimensional)**
 - design, 399, 402-403**
 - file formats, 427
 - hardware requirements, 402-403
 - resources, 444
 - software, 400-401
 - 3-Dimensional Animation, 432
 - ElectricImage, 428-438
 - features chart, 439-443
 - form•Z, 417-427
 - Infini-D, 405-408, 410-416
 - LogoMotion, 404
 - topological levels, 426
- 8/22 sounds, 462-463**
- 8-bit graphics, 452-455**
- 8mm tapes, 204-205**
- 16/44 sounds, 462**
- 16-bit graphics, 453-454**
- 24-bit graphics, 453-454**
- 68k software, 122**
- 601 processors, 137**
- 603e processors, 136**
- 604 processors, 136**
- 7500 Power Macintosh, 147-148**
- 8500 Power Macintosh, 147-148**

A

- A/ROSE (Apple Real-time Operating System Environment), 91**
- A3Mouse, 179**
- accelerators, 117**
 - application-specific, 120-121
 - boards, 311
 - system-wide, 118-120
- Access PC, 511**
- access providers, *see* ISPs (Internet Service Providers)**
- access rates, 193**
- accessing**
 - files, 20
 - Apple menu, 22-24
 - Launcher, 21
 - folders, Controls Panel, 84
- accounting software, 492-493**
 - choosing, 493-494
- Acrobat, 274, 283**
 - ratings, 520
- active virus protection, 124**
- Adaptive option (Photoshop palettes), 285**
- adaptors, 168-169**
 - manufacturers, 170
- ADBs (Apple Desktop Bus connectors), 174**

- Add Bookmark command, 270**
- Additions (PageMaker), 366**
- Adesso keyboards, 175-176**
- adjusting**
 - fonts, 73-74
 - white points, 165
- Adobe Systems**
 - Acrobat, 274, 283
 - ratings, 520
 - After Effects, 402
 - ratings, 448
 - Home Publisher, 352
 - Illustrator, 328, 334-335, 401
 - ratings, 328
 - tools, 336-340
 - PageMaker
 - advantages, 356-357
 - features, 378-384, 393-395
 - CheckList, 393
 - files, 388
 - foreign language extensions, 389
 - keyboard shortcuts, 368-373
 - mailing lists, 354
 - newsgroups, 354
 - plug-ins, 366

- PostScript files, 386-387
- ratings, 353
- troubleshooting, 395
- PageMill, 280, 481
 - ratings, 278
- Photoshop, 306-307, 401
 - automating, 317-319
 - cache cards, 311
 - color calibration, 319-322
 - desktop patterns, 8, 11
 - file formats, 299
 - hard drives, 310
 - icons, 17-18
 - mailing list, 289
 - plug-ins, 311-317
 - RAM requirements, 308-309
 - ratings, 307
- PostScript, 226, 327
- Premiere, 402
 - ratings, 462
- PressWise, 385
- SiteMill, 280
- Streamline, 325-326
- Texture Maker, 11
- Type Manager (ATM), 70
 - ratings, 79
 - version 4.0, 78
- Type Reunion, 79
- URL, 290, 444
- ADT (Aladdin Desktop Tools), 129**
- Advent 3B2, 355**
- Affinity Microsystems, Tempo II Plus, 367**
- AFP (AppleTalk Filing Protocol), 253**
- After Effects, 402**
 - ratings, 448
- AIFF, 463**
- Aladdin Systems, ADT (Aladdin Desktop Tools), 129**
- Albers, Josef, 12**
- aliases, 21, 130**
 - creating, 101
 - utilities, File Buddy, 21
- Alien Skin Software, Black Box filter set, 314**
- aligning icons, 14**
- allocating memory, 35, 53-54, 56-59**
 - Photoshop, 308
- Alps trackpads, 184**
- Alsoft, MasterJuggler, 76-77**
- alt newsgroups, 262**
- altering fonts, Fontographer, 81**
- Alto, 3**
- America Online (AOL)**
 - ratings, 262
 - URL, 289
- American Institute of Graphic Arts, 289**
- Amiga, file formats, 298**
- analog sounds, converting, 460**
- Anarchie, 272**
 - ratings, 288
- animations (3D), 399, 402-403**
 - file formats, 427
 - graphics, 469
 - hardware requirements, 402-403
 - logos, 414-415
- resources, 444
- software, 400-401
 - 3-Dimensional Animation, 432
 - ElectricImage, 428-438
 - features chart, 439-443
 - form•Z, 417-427
 - Infini-D, 405-408, 410-416
 - LogoMotion, 404
 - topological levels, 426
- Anti-virus (Symantec), 124**
- AOL (America Online)**
 - ratings, 262
 - URL, 289
- aperture grill monitors, 156**
- Apple**
 - AppleScript, 28-29
 - hardware/peripherals
 - keyboards, 174-175
 - monitors, 168
 - mouse, 179
 - printers, 228, 232-234
 - scanners, 215
 - software
 - ColorSynch, 383
 - Geoport, 266
 - Language Kits, 389
 - MoviePlayer, 457
 - Multimedia Tuner, 92
 - QuickDraw, 226
 - QuickTake Camera, 468
 - Real-time System Environment (A/ROSE), 91
 - Support and Info Web, 291
 - URL, 444

Apple Adjustable Keyboards, 174
Apple Desktop Bus (ADB) connectors, 174
Apple Guide, 6
Apple menu, 22
 Automated Tasks, 29
 Items folder, 43-44
 navigational tools, 23-24
 Note Pad, 25
 Scrapbook, 26
AppleScript, 28-29
 automation, 126, 317
 ratings, 128
application-specific accelerators, 120-121
applications
 conflicts, avoiding, 35-37
 launching
 aliases, 21
 Apple menu, 22-23
 Launcher, 21-22
 loading, 33-35
 memory
 allocating, 53-54
 partitions, 111
 quitting, force quits, 37
 see also names of individual software applications
applying desktop patterns to utilities, 10
Arachnid, 290
Archie, 272-273
archival back-ups, 39-43
ArtPad, 186
ArtZ II, 186
Ascenders, 73
Astound, 506
Atlas drives, 205

ATM (Adobe Type Manager), 70
 ratings, 79
 version 4.0, 78
audio editors, 289
Auto Backup features, 394
AutoCorrect feature (Word), 486
automated conflict resolution, 95-96
Automated Tasks, 29
automating
 Photoshop
 AppleScript, 317
 Batch-It!, 318-319
 Photomatic, 318
 tasks, 125-127
AutoPage, 366
AutoSave feature (QuarkXPress), 394
Autotrace tool, 336
autotracing, 325, 336

B

BackBurner, 402
backing up
 data, 206
 files, 40-43
 Auto Backup, 394
backup devices, choosing, 42-43
bandwidth, 263-264
banking software, 498
baselines, 73
BAT keyboards, 177
Batch It!, 315, 318-319
BBEedit, 280
Berkeley Systems Espresso, 502
BestWare, M.Y.O.B., 492-493
Bezigon tool (FreeHand), 329, 343
binary searches, 94
bit depth, 460, 462
bitmap fonts
bitmaps, 70, 294-295
 see also images
bits, 452
 bit depth, 460-462
Black Box filter set, 314
black-and-white printers, 225
Blackstar, 291
BMP file format, 298
Bobzilla XTension, 374
bookmarks, adding, 270
Boolean functions
 form•Z, 423
 Infini-D, 410
booting, cold, 37
Broadcast version, ElectricImage, 429
brokers (memory), 63
browsers, 260
 Internet Explorer, 281-282
 Netscape Navigator, 267, 270
Brush tool, 336
Bryce, 419
building animations, 469
bump maps, 410
bus topology, 256
Business LetterWorks, 482-483

businesses

- applications, 475-476
- accounting, 492-494
- banking, 498
- directory assistance, 508-509
- fax/modems, 489-491
- Federal Express shipping software, 508
- PIMs (Personal Information Managers), 500-503
- presentation software, 503-507
- suites, 488-489
- time trackers, 494-498
- word processors, 477-479, 481-487
- works programs, 487-488
- WWW (World Wide Web) uses, 276-277

button bars

- DragStrip, 131-132
- OneClick, 132-133

buttons

- Icon Size, 15
- Net Search, 272
- Set Desktop Pattern, 7-9

buying, see purchasing**bytes, 190****C****C-Curves (control curves), 421****C-Mesh (control mesh), 421****C3 (Complete Conflict Compendium), 94****cables, 192-193**

- null modem, 515
- printers, 229-231

cache

- disk cache, increasing, 114
- memory, 59-61
 - cache cards, 61-62, 311
 - levels, 60-61

Calcomp tablets, 186-187**Calculate Folder Sizes option (Views control panel), 15****calculating**

- graphics file sizes, 454
- memory partition sizes, 111

calibrating colors (Photoshop), 319-322**cameras, Apple QuickTake Camera, 468****Canadian ISPs (Internet Service Providers), 269****Canon, 290****cap heights, 73****Caps Lock (QuarkXPress), 374****Capstans, 224****Capture, 27-28****capturing**

- screen shots, 27
- video, 468

Carbon Copy, 188**cards**

- cache, 60
- PC, 60
 - readers, 62
 - types, 61
- video, 168

cartridges, 39-40**Casady and Greene**

- Conflict Catcher, 88-89, 92-96
- URL, 92

catalog houses, 64**CCDs (charge-coupled devices), 210****CD-ROMs**

- CD audio, 458
- CD-R drives, 194-195, 201-202
- limitations, 472

CDD200 drives, 202**CE Software, QuicKeys, 126****CH Products, trackballs, 183****changing**

- Jigsaw Puzzle images, 12
- memory partitions, 111

CheckList, 393**children's keyboards, 178****Chinese Environment (Sunrise), 389****Chips, 50**

- RAM, 51-52

Chooser, 245**choosing**

- backup devices, 42-43
- ISPs (Internet Service Providers), 266-267
 - regional/national providers chart, 268-269

- keyboard layouts, 98-99

software

- 3D illustration, 399-402
- accounting packages, 493-494
- PIMs (Personal Information Managers), 500-503

- time trackers, 494-498
- word processors, 477-479, 481-482
- see also* purchasing
- ChromaClear monitors, 156**
- CinePak, 465-466**
- CineticGmbh, Text Wizard, 315**
- Claris**
 - ClarisImpact, 507
 - ClarisWorks, 481-488
 - Envelope Assistant, 483
 - Mail Merge Helper, 485
 - Emailer, 287
 - Organizer, 501
- cleaning etched/coated monitors, 160**
- clients, FTP (File Transfer Protocol), 288**
- clip art, 341**
- Clipboard, 24**
 - Photoshop, 310
- clipping sounds, 463**
- Clipping Extension, 92**
- clock-chipping, 119**
- clocks, DigiClock, 24**
- clones, 142**
 - DayStar, 144
 - Power Computing, 143
 - system specifications, 145-146
- Close command (File menu), keyboard shortcuts, 368**
- CloseView, 92**
- CMYK color model (cyan, magenta, yellow, black), 222, 297**
- coatings (monitors), 160**
- cold boots, 37**
- Collect for Output feature (QuarkXPress), 393**
- collecting fonts, Font Sneak, 80**
- Color Book specifications, 195**
- Color Picker, 92**
- color spaces, LAB color, 297**
- color-coding labels, 44-45**
- Color-It!, 301**
- ColorBlind, 384**
- ColorDrive, 384**
- Colorimeters, 167**
- ColorPoint printers, 240**
- colors**
 - calibrating, Photoshop, 319-322
 - color models, 222, 297
 - depths, 452-454
 - monitors, 163
 - scanners, 211
 - desktop patterns, 12
 - displays (monitors), troubleshooting, 169-170
 - gamuts, 164-165
 - management software, 383-384
 - Indexed color, 297
 - matching, 383-384
 - outputting, 222
 - printing, 226
 - process colors, 382
 - spot colors, 382-384
- ColorSynch, 383**
- Combination tool (FreeHand), 342**
- Commands**
 - Edit menu
 - Copy, 8, 17
 - Cut, 10
- Paste, 8
- Select All, 18
- File menu
 - Duplicate, 99
 - Get Info, 17, 35, 53, 90, 308
 - Load, 267
 - New, 8, 17-18, 249
 - Place, 319
 - Sharing, 248
- keyboard shortcuts, 368-373
- Preferences menu, Monitor Preferences, 320
- Resource menu, Create New Resource, 18
- Special menu, Erase Disk, 513
- Tools menu, Envelopes and Lables, 483
- View menu, Tile Documents, 396

Commission International de Eclairage, 297

comp newsgroups, 262

- comp.arch.storage news-group, 208

Compact Pro, 196

comparing prices, memory, 65-66

Complete Conflict Compendium (C3), 94

composite black, 222

composite memory modules, 66

compressing video, 465-468

compression, 41

- LZW, 381
- spatial, 467
- temporal, 467-468

CompuServe

- ratings, 284
- URL, 289

computers

- purchasing, 135-147
- system specifications, 145-146

configuring TCP/IP software, 267**Conflict Catcher, 88, 92-96**

- ratings, 89

conflicts, resolving

- applications, 36-37
- corrupted files, 36-37
- extensions, 93-96
- fonts, 77-78
- INIT/control panel, 35-36
- outdated applications, 37

connecting to the Internet

- hardware requirements, 263-264
- ISPs (Internet Service Providers), 266-269

connectivity, printers, 228**Connectix**

- RAM Doubler, 55, 111
- Speed Doubler, 122-123

Connector tool (FreeHand), 342**connectors, ADBs (Apple Desktop Bus), 174****contrasts, creating (Photoshop), 11****Control curves (C-Curves), 421****Control mesh (C-Mesh), 421****control panels, 3**

- adding, 85
- CloseView, 92
- conflicts, 35

Desktop Patterns, 7-9

File Sharing, 247

Gamma, 165, 319-320

identifying, 90

Keyboard, 98

Labels, 16, 100-101

memory requirements, 88

PC Exchange, 511, 514

removing, 86-87, 91-92

Sharing Setup, 246

Sound, 97

Users and Groups, 249

Views, 14

Control Panels folder, accessing, 84**Control Strip, 129****Convergence, 166****converters**

- analog-to-digital, 460
- digital-to-analog, 461

converting

- file formats
 - HTML conversion utilities, 282-283
 - page layout files, 388
- photos to desktop patterns, 11

Convolver, 312**cooperative multitasking, 52****Copland (System 8), 6****Copy command (Edit menu), 8, 17**

- keyboard shortcuts, 371

copying

- disks, 34
- graphics, 380-381

CopyJet M printers, 236**Cordless Mouseman, 179-180****Corner tool (FreeHand), 342****corruption**

- files, 36-37
- fonts, finding, 77
- RAM, 115-116

counters, 74**crashes, avoiding, 56-57**

- fatal crashes, 33

Create Data Source dialog box, 485**Create New Resource command (Resource menu), 18****creating**

- aliases, 101
- desktop patterns, 10-11
- disk images, 34
- envelopes, 483-484
- fonts, Fontographer, 81
- grids, 12
- icons, 16-18, 45
 - ResEdit, 18
- letters, 482-483
- macros, 126
- multimedia, 469-471
 - animations, 404-438
 - graphics, 451-455
 - sounds, 455-463
 - video, 464-468
- palettes (Photoshop), 285
- QuickTime movies, 468
- RAM disks, 113
 - Photoshop, 309
- slide shows, 504-506
- WWW pages, 278-280,
 - PageMill, 481

cropping graphics, 382

cross-platform files, formatting, 519-521
cross-referencing data, 46-47
cross-sections (Infini-D), 412-413
Curve tool (FreeHand), 342
custom icons, creating, 16, 45
customizing
 desktop, 2-5
 AppleScript, 28
 Automated Tasks, 29
 desktop patterns, 12
 patterns, 7-11
 GUIs (graphical user interfaces), 2-5
 icons, 45
 performance considerations, 106-108
 Photoshop, 16-18
 ResEdit, 18
 Jigsaw Puzzles, 12
 System 8, 6
 windows, 13
 fonts, 14
 labels, 16
Cut command (Edit menu), 10
 keyboard shortcuts, 371
CX printers, 237
Cybermesh, 315
Cytopla Software, PhotoLab, 315

D

Dantz, Retrospect, 40
DAs (Desk Accessories), see control panels
DAT (digital-audio technology), 196
 drives, 196
 tapes, 204

data
 backing up, 206
 cross-referencing, 46
 diskettes, 196-197
 recovering, 36
 storing, 189-192
 Clipboard, 24-25
 drives, 193-195, 198-203
 tapes, 196-197, 204-205
databases, 476
 importing from Windows, 515
Datadesk keyboards, 175
DataViz translators, 517
Datawatch, Virex, 37
Date view, 13
DayStar Digital
 accelerators, 119
 Macintosh clones, 144-146
 Photomatic, 318
DCI home page, 289
DCS (Desktop Color Separation), 298
DDS2 drives, 204
deadlines, meeting, 32
deallocating memory, 89
DeBabelizer, 387, 402, 517
Decal mode (Infini-D), 410
decreasing RAM consumption, 54, 88
defining style sheets, 375-377
Deformation tools (form•Z), 420
defragmenting disk drives, 108-109, 207-208
degaussers, 164
deleting tiles (desktop patterns), 10

Deneba Canvas, 330, 347
Depository Trust Company, logo animation, 414
depths
 bit depth, 460, 462
 color depth, 452-454
Derivative tools (form•Z), 419
descenders, 74
design axis, 73
Design Tools Monthly, 366
designing
 cross-platform files, 519-521
 desktop patterns, 12
 fonts, Fontographer, 81
 icons, 19-20
 multimedia, 446-450
Designlink, 291
DesignSpec, 496-498
Desk Accessories (DAs), see control panels
DeskScan, 217
DeskSetters, 240
desktop, 3
 customizing, 2-5
 AppleScript, 28-29
 files, storing, 44
 navigating, 20
 Apple menu, 22-24
 Launcher, 21
 patterns
 choosing, 7
 creating, 8-12
 rebuilding, 35, 106
 TechTool, 107
Desktop Color Separation (DCF), 298
Desktop Patterns control panel, 7-9

desktop publishing

- files, preflighting, 390-393
- mailing lists, 354
- newsgroups, 354
- software, 352
 - add-ons, 366
 - Advent 3B2
 - Professional, 355
 - capabilities, 374-379
 - choosing, 354-365
 - color systems, 382-384
 - electronic imposition, 385-387
 - foreign language extensions, 389
 - FrameMaker, 358, 361-363
 - graphics-handling, 380-381
 - keyboard shortcuts, 367-373
 - limitations, 355
 - PageMaker, 353
 - QuarkXPress, 353, 361
 - UniQorn, 355
 - VivaPress
 - Professional, 355

DeskWriters, 234

- ratings, 233

diagnostic software, 38**dial-up software, configuring, 267****dialog boxes**

- Create mail Merge, 485
- Erase Disk, 513
- Fax Print, 489
- General Preferences, 310
- Global Update Options, 376-377

- Lens Flare, 407
- Levels, 321-322
- PostScript file, 386
- Printing inks setup, 321-322
- Transfer Settings, 514-515
- Velocity, 408

DigiClock, 24**Digital Frontiers, HVS Color, 315****Digital PhotoAlbum, 62****digital technology**

- audio, 459-463
- photography, 61-62
- video, 464-468

digital signal processors (DSPs), 311**digital-to-analog converters, 461****digitizing**

- sounds, 460-463
- videos, 464-466

DIMMs (Dual Inline Memory Modules), 50

- advantages, 137-138
- installing, 64
- interleaving, 114-115

Direct Selection tool, 336**Director, 402**

- files
 - importing, 469-471
 - minimizing, 471-472
- graphics, converting to 8-bit, 455
- ratings, 450

directory assistance software, 508**disabling extensions, 91-92**

- Quark XTensions, 396

Disinfectant, 124-125**disk arrays, 110****disk cache sizes, increasing, 114****Disk Cache setting (Memory control panel), 59****disk drives, defragmenting, 108-109****disk images, creating, 34****Disk tools, 207-208****DiskDoctor, 38, 208****disks**

- copying, 34
- floppy, 196-197
- formatting, DOS, 513
- RAM, 50
 - creating, 113, 309

displaying Keyboard menu, 99**displays (monitors), 151-153**

- color depth, 163
- distortion, 164
- dot pitch, 155-156
- etchings/coatings, 160
- raster images, 158-159
- refresh rates, 157
- resolutions, 161-162
- screen curvature, 154-155
- troubleshooting, 169-170
- white points, 165

distortion (monitors), 164**Distortion plug-ins, 338****dithered images, 452****DLTs (digital-linear tapes), 196, 204****Document Setup command (File menu), keyboard shortcuts, 368****documents, converting, 282-283**

DocuNet Digital Document Services, 291

DOS

- compatibility cards, 519
- emulating, 517-519
- files
 - exporting to
 - Macintosh, 512-515
 - extensions, 512-513
 - translating, 516-517

DOS Mounter, 511

DOSWasher, 517

dot pitch, 152-153, 155-156

dots per inch (DPI), 161-162, 224, 295, 327

DoundApp, 289

downloading

- fonts, 274
- graphics, 270
- software, 274-275

DPI (dots per inch), 161-162, 224, 295, 327

Drafting mode (form•Z), 421-423

drag-and-drop color (FreeHand), 346

DragStrip, 131-132

DRAM (Dynamic Random Access Memory), 50-52, 116

- corruption, 115-116

Drawing tools, 334

- form•Z, 419

DrawingSlate II, 186-187

DrawTools, 349

Dream World Productions, logo animations, 414-415

drivers, 228-231

drives

- access/transfer rates, 193
- cabling, 192
- capacities, 41
- choosing, 42-43, 191-195
- DAT (digital-audio technology), 196
- defragmenting, 207-208
- disk tools, 207
- optical, 194-195, 201-203
 - manufacturers, 200
- print servers, 227
- purchasing, 190
- RAIDs (redundant arrays of inexpensive drives), 205-206
- ratings
 - Compact Pro, 196
 - Iomega Zip, 198
 - SyQuest, 199-200
 - Winchester, 193-194
- drum scanners, 213, 219, 224**
- DSPs (digital signal processors), 311**
- DTP Internet Jumplist, 209, 289**
- Dual Inline Memory Modules, see DIMMs**
- DuoScan, 214**
- Duplicate command (File menu), 99**
- duplicate extensions, conflicts, 97**
- duplicate fonts, conflicts, 77**
- duplicating files, 34**
 - DXF files, 295

dye-sublimation printers, 223-224

- manufacturers, 238-240

Dynamic Random Access Memory, see DRAM

dynamic ranges, scanners, 212

E

email servers, 254

Easter Eggs, 24

Easy Access, 92

Easy Open, 387

Edit menu commands

- Copy, 8, 17
- Cut, 10
- Paste, 8
- Select All, 18

editing video, 468

EDO (Extended Data Output), 50

EfiColor, 383

EINet Galaxy, 289

ElectricImage, 401, 428-429

- features chart, 439-443
- files, importing, 433
- models, linking, 431-433
- plug-ins, 433
- sample animations, 434-438
- tools, 429-431
- URL, 444

electronic imposition, 384

- software, 385-387

electronic publisher software, 519-521

Elite printers, 235

em dashes, 486

EM Extension, 92

Emailer, 287

embedding graphics, 380-381

emulating Windows, 517-519

en dashes, 486

Encapsulated PostScript (EPS), 298

encryption, 41

Envelope filter (SoundEdit 16), 463

envelopes, printing, 483-484

Envelopes and Labels dialog box, 484

Envelopes and Labels command (Tools menu), 483

Envoy, 519-521

Epilogue, 316

EPS (Encapsulated PostScript) files, 298, 381

- nesting, 381-382

Epson

- printers, Stylus, 233
- scanners, 216

Equation editor (FrameMaker), 363

Equilibrium Software

- DeBabelizer, 402, 517
- URL, 444

Erase Disk command (Special menu), 513

ergonomic keyboards, 176-177

error messages, QuarkXPress, 395-396

ESP Converter, 387

etchings (monitors), 160

Ethernet, 3, 228, 244

Eudora, 287

Eurocore Hi Scan, 219

EX105 drives, 197-198

Exact option (Photoshop palettes), 285

Excel, 504

expanding memory, 111-114

Export Clipboard option (Photoshop), 310

exporting

- files
 - DOS, 512-515
 - form•Z, 427
 - text, 388

Extended Data Output, *see* EDO

Extension Manager, 91

- ratings, 85
- utilities, 88

Extension mapping, 512

extensions, 3, 91-92, 512-513

- conflicts, resolving, 93-96
- duplicates, 97
- Netscape, 281-282
- sets, 93
- System Folder, 84
 - adding, 85
 - identifying, 90
 - memory requirements, 88
 - removing, 86-89, 91-92

Extensis Software, 316

external drives, choosing, 140-141

external modems, 265

EZ 105 drives, 200

EZ 135 drives, 197-199

EZVision, 458

F

FAQs (frequently asked questions), 275-276

Fargo printers, 238-239

FastEdit Deluxe, 316-317

fat binary applications, 122

fatal crashes, avoiding, 33

Fauve Software, xRES, 303-305

Fax Print dialog box, 489

faxes

- fax machines, 490
- fax/modems, 476, 489-490
- fonts, choosing, 491
- sending, 266, 489-490
- software, 491

FAXstf, 491

FBI plug-in, 315

Federal Express shipping software, 508

Fetch, 288

File Buddy, 21, 105-106

file mapping, 54-55

File menu commands

- Duplicate, 99
- Get Info, 17, 35, 53, 90, 308
- keyboard shortcuts, 368
- Load, 267
- New, 8, 17-18, 249
- Place, 319
- Sharing, 248

file servers, 253

file sharing, 243, 246-247

- assess, restricting, 251
- groups, creating, 250

File Sharing control panel, 247

File Transfer Protocol (FTP), 288**FileMaker Pro, 497****filename extensions, 512-513****files**

accessing, 20

Apple menu, 22-24

Launcher, 21

backing up, 40-43

Auto Backup, 394

conflicts, 35, 37

corrupted, 36-37

digital audio, 459-463

DOS/Windows

importing, 512-515

translating, 516-517

duplicating, 34

exporting, 427

extensions, 512-513

Finder, 4

formats, 298-300, 381

animation programs, 427

bitmaps, 294

FilmStrip, 299

GIF (Graphics

Interchange

Format), 284-286

HAM (Hold and Modify) file format, 298

IFF (International File Format), 298

JPEG (Joint Photographic Experts Group), 286

LRG file format, 299, 303-305

PDF (Portable Document Format), 283, 520

PNG (Portable Network Graphics), 517

translating, 387-388

vector-based, 295

fragmentation, 108

linked, 469-471

loading, 33-37

Ole No Moire, 321

organizing, 31-34, 46-47

tools, 43-45

preflighting, 390-393

printing

electronic imposition, 386-387

Print Inks preferences, 320-322

Read Me, 34

saving, Autosave, 394

sizes, 295-296

storing, 38-39

back-ups, 42-43

System File, 4-5

transferring, 287-288

unlinked, 469-471

fills, 324**film imposition, 386-387****Film version,****ElectricImage, 429****FilmStrip file format, 299****filters**

Black Box, 314

desktop patterns, 11

Gallery Effects, 314

IntelliHance, 316

KPYVector, 313

L1, 462

plug-ins, 338

Finder, 4

views, 13-14

First Things First PIM (Personal Information Manager), 502-503**FITS technology, 306****Flash-it, 27-28****flat-screen monitors, 154-155****flatbed scanners, 214****floppy disks, choosing, 196-197****floppy drives, 191****FM (frequency modulation) screening, 382****Folder Icon Maker, 18****folders**

files, organizing, 44

Font, organizing, 74-78

sizes, calculating, 15

System Folder, 4, 83

Control Panels, 84-87

Extensions, 84-87

Font Manager, 4, 76**Font menus, organizing, 79****Font Sneak, 80, 393****Font/DA Mover, 96****Fontographer, 81****Fonts, 69, 227**

choosing (faxes), 491

collecting, Font Sneak, 80

conflicts, resolving, 77-78

corruption, 36

creating, Fontographer, 81

foreign language fonts, 389

installing, 70-71

kerning, 72-73

listing, 391

Multiple Master fonts, 73-74

- organizing, 74
 - management utilities, 75-79
 - suitcases, 75
 - samples, printing, 80
 - type styles, 70-72
- FontsOnline, 274**
 - URL, 289
- force-quits, 37**
- form•Z, 400**
 - Boolean functions, 423
 - features chart, 439-443
 - files, exporting, 427
 - help system, 427
 - interface, 417
 - modeling, 421-426
 - tools, 418-420
 - modifiers, 426
 - URL, 444
- formats (files), 298-300**
 - FACT, 427
 - files, 381
 - GIF (Graphics Interchange Format), 284-286
 - HAM (Hold and Modify) file format, 298
 - IFF (International File Format), 298
 - JPEG (Joint Photographic Experts Group), 286
 - LRG file format, 299, 303-305
 - PDF (Portable Document Format), 283, 520
 - PNG (Portable Network Graphics), 517
 - translating, 387-388

- formatting**
 - cross-platform files, 519-521
 - disks, DOS, 513
- forms (WWW), 481**
- Fractal Design Painter, 302-303**
- fragmentation, 56, 108**
- Frame mode (ElectricImage), 430**
- FrameMaker, 358**
 - advantages, 361-363
 - features
 - color systems, 383-384
 - embedded graphics, 380-381
 - master pages, 378
 - navigational tools, 374
 - style sheets, 376-377
 - keyboard shortcuts, 368-373
 - p1 patch, 391
 - PostScript files, generating, 386-387
 - text, exporting, 388
- FreeHand, 323, 328**
 - drag-and-drop color, 346
 - Inspector palette, 344
 - ratings, 328
 - tools, 342-343
- Freehand tool, 336**
- frequency modulation (FM) screening, 382**
- Frontier, 127**
- FTP (File Transfer Protocol), 288-289**
- FWB, Sledgehammer disk arrays, 110**

G

- Gallery Effects, 314**
- Gamma control panel, 165, 319-320**
- gas plasma displays, 150**
- GCC printers, 235**
- GDT Software, PowerPrint, 522**
- General MIDI (GM) standard, 456**
- General Preferences dialog box (Photoshop), 310**
- generating PostScript files, 386-387**
- geometry settings (monitors), 167**
- Geoport modems, 266**
- Get Info command (File menu), 17, 35, 53, 90, 308**
- Get Info window, 53, 90**
 - memory partition options, 111
- GIF (Graphics Interchange Format), 284-286, 298, 381**
 - interlaced, 285
 - transparent (GIF89s), 286
- GIF89s, 286**
- gigabytes, 190**
- glare (monitors), reducing, 165**
- Global Prepress Center, 291**
- Global Update Options dialog box, 376-377**
- GM (General MIDI) standard, 456**
- GNN's Whole Internet Catalog, 289**
- GNNPress, 480**
- Gold Disk, Astound, 506**

Grabber hand (page layout programs), 374

grammar checkers, 486-487

Grammatic Mac, 486

Graphic Converter, 387

Graphical User Interfaces, see GUIs

graphics

- animating, 469
- colors
 - color depth, 453-454
 - color systems, 383-384
- converting to 8-bit, 455
- cropping, 382
- embedding, 380-381
- files, 381
 - converting, 387
 - formats, 284-286, 298-300, 517
- fills, 324
- organizing, 47
- PostScript, 327
- raster, 324
- referencing, 380-381
- resolution, 451-452
- scanning, 382
- sizes, 454
- slide shows, creating, 505-506
- translating, 517
- vectors, 323-324

Graphics Design Books Information, 289

Graphics Interchange Format, see GIF

Graphics on Call, 291

Graphics tablet, 334

Graphion's Online Type Museum, 274

URL, 289

grayscale document, printing, 225

grids, creating, 12

Group Selection tool, 336

groups, creating, 250

Gryphon Software Corp., Batch It!, 315, 318-319

GUIs (graphical user interfaces), 4-5

- customizing, 2-3
- Finder, 4

H

Hagiwara Sys-Com trackpads, 184

halftones, 224

HAM (Hold and Modify) file format, 298

Han Korean Kit (Hansoft), 389

hard drives, 190-191, 205

- access/transfer rates, 193
- aliases, creating, 23
- cablings, 192
- capacities, 41
- limitations, 109
- maintenance, 104-107
- optical, 194-195, 201
 - manufacturers, 200
- optimizing
 - defragmentation, 108-109
 - disk arrays, 110
 - Photoshop, 310
 - purchasing, 139-141
 - Winchester, 193-194

hardware, 263-264

- cables, 192-193
 - null modem, 515
- compressors, 465-466

DOS-compatibility cards, 519

drives, 40-42, 203

- access/transfer rates, 193
- cables, 192
- LaCie Joule, 200
- maintenance, 104-109
- manufacturers, 197-200
- optical, 194-195, 201-202
- optimizing, 110
- purchasing, 190-191
- RAIDs (redundant arrays of inexpensive drives), 205-206
- SyQuest, 199-200
- Winchester, 193-194
- Zip, 198

fax/modems, 476

imagesetters, 224

Macintosh/PC compatibility, 521-522

modems, 264

- fax/modems, 489-490
- purchasing, 265-266

monitors, 149, 163-169

- displays, 150-160, 452
- manufacturers, 170-172
- secondary, 153-154
- sizes, 150-154
- troubleshooting, 161-163, 169-170

video cards, 168

printers, 221

- choosing, 225-226
- drivers, 228-231
- inkjet, 222-223

- interpolation, 224
- laser, 223
- print speeds, 227
- purchasing, 232-240
- thermal-wax, 223
- troubleshooting, 397
- system requirements,
 - multimedia, 447
- tapes, 204-205
- hardware accelerators, 117-119**
- hardwiring, 174**
- Hayden Books URL, 444**
- Health Care Keyboard, 176**
- Health Rider, animations, 434-436**
- heaps, 52**
- Help systems (form•Z), 427**
- Help!, 38**
- Hewlett-Packard**
 - printers
 - DeskWriters, 233-234
 - LaserJets, 235-236
 - scanners, 216
 - URL, 290
- hi-fi process printing, 382**
- High Sierra format, 195**
- HighWater Designs, FBI plug-in, 315**
- Hitachi tablets, 187**
- Hold and Modify (HAM) file format, 298**
- Hollywood Online, 449**
- home pages (WWW)**
 - creating, 278-280
 - marketing, 281-282
- Home Publisher, 352**
- HORDE Concert Tour CD animation, 436-438**

- horizontal/vertical placement settings (monitors), 167**
- HSL (hue, saturation, lightness) color model, 297**
- HTML (HyperText Markup Language), 278-280, 479**
 - conversion utilities, 290
 - editors, 480-481
- HVS Color, 315**
- HyperTerminal, 514**
- HyperText Markup Language, see HTML**

I

- I/O devices, PC cards, 61**
- IBM, 290**
- ICC (International Color Consortium), 383**
- Icon Size radio button, 15**
- Icon view, 13**
- icons**
 - aligning, 14
 - creating, 17-20
 - customizing, 16, 18
 - performance considerations, 106-108
 - resizing, 15
 - sizing, 44
- iContraption, 18**
- IDE drives, 192**
- identifying**
 - control panels, 90
 - extensions, 90
 - extension conflicts, 93-96
- IDs**
 - fonts, conflicts, 77-78
 - SCSI, setting, 207
- IFF (International File Format), 298**
- Illustrator, 323, 334-335, 401**
 - clip art, 341
 - files, exporting to Photoshop, 319
 - ratings, 328
 - special effects, 340
 - tools, 336-340, 344
 - typographic features, 340
- Image View (IVUE) format, 299**
- Image2Mesh, 433**
- images, 293**
 - color models, 297, 383-384
 - depths, 452
 - files
 - formats, 298-300, 381
 - sizes, 295-296
 - fills, 324
 - image-processing software, 300
 - Color-It!, 301
 - Fractal Design Painter, 303
 - Gractal Design Painter, 302
 - Live Picture, 305-306
 - Photoshop, 306-322
 - xRES, 303-305
 - Jigsaw Puzzle, changing, 12
 - PostScript, 327
 - raster, 324
 - referencing, 380-381
 - resolution, 294-296
 - scanning, 382
 - screen captures, 27-28
 - storing, Scrapbook, 26
 - vector, 323-324

- viewing, image viewers, 26
- WWW (World Wide Web), 284-286
- imagesetters, 224**
 - manufacturers, 240
- ImageWriters, 229**
- ImMedia, iContraption, 18**
- importing**
 - files
 - Director, 469-471
 - DOS/Windows, 512-515
 - graphics, 380-381
 - style sheets, 376
- imposition, 385-387**
- increasing**
 - disk cache, 114
 - memory, RAM Doubler, 55
 - processor speeds, 118-119
 - productivity, 130-133
 - automation, 125-127
 - utilities, 128-129
- Indexed color, 297**
- Infini-D, 400**
 - features chart, 439-443
 - interface, 405
 - sample animations, 414-416
 - Workshop, 411-413
 - World
 - Boolean functions, 410
 - ShadowCatchers, 410
 - surface composition, 410
 - tools, 405-408
 - velocity controls, 408
- Infini-D Production Studio, 403**
- Infogrip, BAT keyboard, 177**
- InfoSeel, 291**
- inkjet printers, 222-223**
 - Apple StyleWriters, 232-233
 - Epson Stylus, 233
 - Hewlett-Packard DeskWriters, 233-234
 - Tektronix, 234
- INposition Lite, 385**
- Insignia Solutions**
 - SoftWindows, 517-519
- Inspector palette (FreeHand), 344**
- Installer, 35**
- installing**
 - DOS-compatibility cards, 519
 - files, 33-37
 - fonts 70-71
 - memory, 64-65
- integrating media, 469-471**
- IntelliHance, 316**
- interlaced GIFs, 285**
- interlaced monitors, 154**
- interleaving, 138-139**
 - RAM, 114-115
- internal cache, 60-61**
- internal hard drives, 190-191**
 - purchasing, 140-141
- internal modems, 265**
- International Color Consortium (ICC), 383**
- International File Format (IFF), 298**
- Internet, 259-260**
 - connecting to
 - hardware requirements, 263-264
 - ISPs (Internet Service Providers), 266-269
 - resources
 - design information, 275-276
 - font houses, 274
 - software suppliers, 275
 - stock houses, 273
 - search engines, 271-273
 - URLs, 291
 - WWW (World Wide Web), 260, 479-481
 - browsers, 267, 270
 - commercial uses, 276-277
 - pages, 278-282
- Internet Explorer, 281-282**
- Internet Font Archives, 289**
- Internet Font Browser, 289**
- Internet Service Providers (ISPs)**
 - choosing, 266-267
 - national/regional providers chart, 268-269
- Interpolation, 224**
 - scanners, 211
- intranets, 260**
- Intuit QuickBooks, 498-499**
- Invar monitors, 156**
- Inverse Kenematics (ElectricImage), 432**
- Iomega drives, Jaz, 202**
- Iomega, Zip drive, 197-198**
- ISDN connections, 264**
 - advantages, 191

isolating extension conflicts, 93-96

ISPs (Internet Service Providers)

America Online (AOL), 262, 289

choosing, 266-267

CompuServe, 284

national/regional providers chart, 268-269

Itac, Mouse-Trak, 183

Items folder (Apple menu), 43-44

IVUE (Image View), 299

J

Jade, 26

Jaz drives, 203

Jigsaw Puzzle images, changing, 12

job types, cross-referencing, 47

Jobs, Steve, 3

Joint Photographic Experts Group (JPEG), 299

Joule drives, 200

journals, page layout software, 359-360

JPEG (Joint Photographic Experts Group), 286, 299, 381

Jughead, 272-273

K

Kai's Power Tools, 311-312

Kensington

Thinking mouse, 180

trackballs, 182

kerning text, 72-73

page layout software, 378-380

Keyboard control panel, 98

Keyboard menu, displaying, 99

keyboard shortcuts

⌘+D, 99

⌘+I, 18, 35

⌘+M, 101

⌘+Option+Esc, 37

⌘+Option+P+R, 95, 117

⌘+Shift+3, 27

⌘+X, 10

summary chart, 368-373

keyboards, 173-174

Apple standard, 175-176

children's, 178

ergonomic, 176-177

layouts, choosing, 98-99

trackball keyboards, 175

trackpad keyboards, 176

KidBoard, 178

Kids Keys (keyboards), 178

Kind view, 13

Knoll Software

CyberMesh, 315

Gamma control panel, 165

Kodak

CMS, 384

imagesetters, 240

printers, 239

slide scanners, 218

Korean Kit (Hansoft), 389

KPT

Bryce, 313

Seamless Welder, 11

Texture Explorer, 11

Vector, 313

L

L1 filter, 462

LAB color model, 297

Label view, 13

labels (icons), 15, 99-100

color-coding, 44-45

customizing, 16

selecting, 101

Labels control panel, 16, 100-101

LaCie

drives, 200

scanners, 217

landscape generators, KPT Bryce, 313

Language Kits, 389

languages

foreign languages, page layout extensions, 389

programming

AppleScript, 28-29

HTML, 479-481

SmallTalk, 3

laser printers, 223

Apple LaserWriters, 234

drivers, 229-231

drivers, 229-231

fonts, 227

GCC, 235

Hewlett-Packard, 235-236

history, 3

QMS, 237

Tectronix, 237

Xerox, 237

LaserJets, 235-236

LaserWriters, 234

drivers, 229, 230-231

NBP Lookup Requests, 246

Launcher, 21-22
launching applications
 aliases, 21
 Apple menu, 22-23
 Launcher, 21-22
LCD displays, 150
LEDs (light-emitting diodes), 223
Lens Flare dialog box, 407
Letraset, 289
letters
 creating, 482-483
 mail merges, 484-485
LetterWorks, 482-483
levels, cache memory, 60-61
Levels dialog box, 321-322
LifeGuard, 509-510
Light Floater (Infini-D), 406
light-emitting diodes (LEDs), 223
LIM-DOW, 201
line feed characters, removing, 517
lines per inch (LPI), 224, 295
linked files, 469-471
linking models (ElectricImage), 431-433
links (hyperlinks), 270, 481
List by Label option (Finder), 100-101
listing fonts, 391
Little Mouse ABD, 179
Live Picture, 305-306
Load command (File menu), 267
loading
 files, 33-37
 URLs, 267

LocalTalk, 228, 243
lock-ups, see conflicts
Logitech
 Cordless Mouseman, 179-180
 trackballs, 183-184
LogoMotion, 400, 404
 features chart, 439-443
logos, animating, 414-415
Lowly Apprentice, Photoshop plug-ins, 316
LPI (lines per inch), 224, 295
LRG file format, 299, 303-305
Lycos, 272
LZW compression, 381

M

M.Y.O.B., 492-493
Mac's Clean Sweep, 105-106
MacAlly
 keyboards, 175
 URL, 177
MacBinary formatting, turning off, 514-515
MacinTalk, 86, 459
MacInTax, 499
Macintosh Extensions Guide Web page, 91
MacLink Plus, 387
MacOS Purge, 89, 115
MacPaint, 299, 381
MacPublisher, 352
Macromedia
 Director, 402, 469-471
 ratings, 450
 FreeHand, 323, 328, 342-344
 SoundEdit 16, 460-463
 URLs, 290, 444, 473
macros, creating, 126
MacTRAC, 183
magazines, layout software, 359
magnetism, effects on monitors, 164
Magneto-optical (MO) drives, 194-195, 200-201
mail merges, 484-485
mailing lists
 desktop publishing, 354
 Photoshop, 289
maintenance, hard drives, 104-109
managers, 4-5
 Alias, 21
 Extensions, 85, 91
 Fonts, 76
 Memory, 52, 56-57
 Modem Memory, 50
 Startup, 92
 conflict resolution, 95-96
 Type, 70
manufacturers (hardware/software), see names of individual manufacturers
maps (ElectricImage), 430
market research, WWW (World Wide Web) resources, 277
marketing WWW (World Wide Web) pages, 281-282
MarksTools II, 395
Markzware, PM-QXP XTension, 388
master pages, 375-378
MasterJuggler, 76-77
matching colors, 383-384

MathType preference file,
392

Matrix, Millenium, 120

manual conflict resolution,
94

Maui Software,
TimeTracker, 494-495

measuring

bandwidth, 264

image resolution, 295

meeting deadlines, 32

megabytes, 190

memory

allocating, 35, 53-59

Photoshop, 308

boards, 67

cache memory, 59-61

fragmentation, 56

installing, 64-65

managing, 49-50

modules, 66-67

partitions, 111

purchasing, 62, 137-139,
141

brokers, 63

catalogs, 64

cost considerations,
65-66

manufacturers, 63

questions to ask,
66-67

RAM, 51-52, 114

corruption, 115-116

deallocating, 89

performance,
110-113

purchasing, 67

SRAM (Static
Random Access
Memory), 59-61

VRAM (Video
Random Access
Memory), 58-59

requirements, Multiple
Master fonts, 73

virtual, 53-54

memory brokers, 63

Memory control panel

Disk Cache setting, 59

RAM disks, creating,
113

Memory Manager, 52,
56-57

Mesh tools (form•Z),
419-420

MetaTools

KPT Bryce, 313, 419

KPT Vector, 313

KPT Convolver, 312

Metrolive Software, MacOS

Purge, 115

Micro Frontier, Color-It!,
301

microboards, 202

MicroMat Computer
Systems, TechTool, 96,
117

microprocessors

purchasing, 136-137

speeds, 141

MicroQue trackpads, 184

Microsoft

Easy Open, 387

Internet Explorer,
281-282

Office, 488-489

PowerPoint, 505-506

URL, 290

Word, 477

WordPerfect, 478-479

Works, 487-488

Microspeed

MacTRAC, 183

mouse, 181

Microtech International,
Digital PhotoAlbum, 62

MIDI (Musical Instrument
Digital Interface),
456-458

Millenium, 120

Mini-save feature
(PageMaker), 395

minimizing Director file
sizes, 471-472

Minolta scanners, 218

mirroring drives, 205-206

misc newsgroups, 262

"missing" memory,
115-116

Mitsubishi monitors,
152-153

MO (magneto-optical dri-
ves), 200-201

modeling (3D), 348, 403
form•Z, 421-426

models

choosing, 135-144

linking, ElectricImage,
431-433

specifications, 145-146

Modem Memory Manager,
50

modem servers, 255

modems, 264

cables, 515

fax/modems, 489-490

purchasing, 265-266

modified graphics, import-
ing, 381

Modifiers (form•Z tools),
426

modifying

desktop patterns, 8

fonts, Fontographer, 81

modules (memory), 66-67
Monitor Expander, 159
Monitor Preferences command (Preferences menu), 320
monitors, 149
 adaptors, 168-169
 colorimeters, 167
 digital settings, 166-167
 Macintosh/PC compatibility, 521
 manufacturers, 170-172
 ratings
 Apple, 168
 NEC, 156
 Radius, 166
 Sony, 150
 secondary, 153-154
 sizes, choosing, 150-154
 specifications, 150-151
 color depth, 163
 colors, 165
 dot pitch, 152-156
 etchings/coatings, 160
 pixel depth, 452
 raster images, 158-159
 refresh rates, 157
 resolutions, 161-163, 296
 screen curvature, 154-155
 white points, 165
 troubleshooting, 169-170
 distortion, 164
 glare, 165
 video cards, 168
Monitors preferences setting, 320
MOST, 201

mouse, 178, 331
 cordless, 179
 multi-button, 180-181
 optical, 179
 single-button, 179
Mouse Systems, 179
Mouse-in-a-Box, 180
MouseTrak, 183
MoviePlayer, 457
Multi-Ad Creator, 352, 365
multi-button mouse, 180-181
multimedia, 445
 animations, 400-403
 creating, 469-471
 delivery, 471-472
 Windows platforms, 473
 designing, 446-450
 graphics
 color depth, 452-455
 resolution, 451-452
 playback, WWW (World Wide Web), 449
 programming, 450
 software, 507
 sounds
 CD audio, 458
 creating, 455
 digital audio, 459-463
 MIDI files, 456-458
 synthesized speech, 458-459
 system requirements, 447
 testing, 451
 video, 464-468
multiple master fonts, 73-74
multiple monitors, 152-153
multisynch monitors, 521

multitasking, cooperative, 52
Multitimer, 495
music, playback, 456-458
Musical Instruments (extension), 92
Musical Instrument Digital Interface (MIDI), 456-458

N

Name view, 13
nanoseconds, 50
native software, 121-122
Natural Intelligence, DragStrip, 131-132
navigating the desktop, 20
 Apple menu, 22-24
 Launcher, 21
Navigation Floater (Infini-D), 406
Navigator (Netscape), 270
 plug-ins, 270
 Acrobat, 274
 ratings, 267
NaviPress, 290
NBP (Name Binding Protocol), 246
NCSA Mosaic, 290
near-line storage, 39
NEC
 monitors, 156
 URL, 290
nesting EPS (Encapsulated PostScript) files, 382
Net Search button, Netscape, 272
Net, see Internet
Netphone, 290
NetPresenz, 288
Netscape
 Dynamic Document Features, 289

- extensions, 281-282
- Navigator
 - plug-ins, 270
 - ratings, 267
- URL, 290
- networking, 243**
 - Chooser, 245
 - Ethernet, 244
 - file sharing, 246
 - access restrictions, 251
 - groups, 250
 - LocalTalk, 243
 - Open Transport, 244
 - packets, 245
 - protocols
 - AFP (AppleTalk Filing Protocol), 253
 - NBP (Name Binding Protocol), 246
 - TCP/IP (Transmission Control Protocol/Internet Protocol), 253
 - ZIP (Zone Information Protocol), 246
 - rendering, 258
 - servers, 253
 - topologies, 256
- networks**
 - Internet, 259-264
 - Usenet, 261-263
 - wireless, 257
- New command (File menu), 8, 17-18, 249**
 - keyboard shortcuts, 368
- news readers, 263**
 - NewsWatcher, 261
- news servers, 261-262**

- newsgroups, 261**
 - comp.arch.storage, 208
 - desktop publishing, 354
 - subscribing to, 262-263
- newspapers, page layout software, 364**
- Nikon scanners, 219**
- Nisus Writer, 478**
- No Hands Software, Common Ground, 519**
- Noise filters, 11**
- non-composite memory modules, 66-67**
- non-interlaced monitors, 154**
- Normalize filter (SoundEdit 16), 463**
- Norstad, John, 124-125**
- Norton**
 - DiskDoctor, 38
 - Utilities, 109
- Note Pad, 25**
- Now Software**
 - Contact, 501
 - ratings, 476
 - Startup Manager, 88, 92
 - conflict resolution, 95-96
 - Up-to-Date, 500
 - Utilities, 128
 - WWW site, 92
- null modem cables, 515**
- nurbs, 421**

O

- Object Floater (Infini-D), 406**
- object-oriented software, 323**
- oblique typefaces, 72**
- Ocean Systems, MO (magneto-optical drives), 201**
- OCR (optical character recognition), 490**
- off-line storage, 39**
- Olbicard, Image2Mesh, 433**
- Ole No Moire files, 321**
- OmniPage, 210**
- on-line storage, 38**
- one-button mouse, 179**
- OneClick, 127, 132-133**
- Online Prepress Service, 291**
- Onyz, Tree Pro, 433**
- OPC (organic photoconductor) drums, 223**
- Opcode, EZVision, 458**
- Open command (File menu), keyboard shortcuts, 368**
- Open Transport, 244**
- operators (Boolean functions), 410**
- optical character recognition (OCR), 490**
- optical drives, 194-195**
 - CD-R drives, 201-202
 - manufacturers, 200
- optical mouse, 179**
- OptiMem, RAM Charger, 55**
- optimizing**
 - hardware, 103
 - accelerators, 120-121
 - hard drives, 104-110
 - hardware accelerators, 117-119
 - memory, 54-55, 60-61, 110-117
 - Photoshop, speed, 308-311
 - software, 121-123

Optronics

- imagesetters, 240
- scanners, 220

organic photoconductor (OPC) drums, 223**Organizer (Claris), 501****organizers, see PIMs (Personal Information Managers)****organizing**

- files, 31-34, 46-47
 - aliases, 130
 - button bars, 131-132
 - storage methods, 38-39
 - tools, 43-45
- fonts, 74
 - management utilities, 75-79
 - suitcases, 75
- software, 46-47
- System Folder, 99-101

OS (operating system), 1-5

- crashes, avoiding, 56-57
- reinstalling, 35
- System 8, 6

outdated applications, system conflicts, 37**output parameters, 392****outputting**

- colors, 222
- files, 390-393

overlays, 478

P**packets, 245****page layout**

- documents, converting, 388
- files, preflighting, 390-393

- mailing lists, 354
- newsgroups, 354
- software, 352-353, 358, 361-363
 - add-ons, 366
 - Advent 3B2, 355
 - capabilities, 378-379
 - choosing, 354-360, 364-365
 - color systems, 382-384
 - foreign language extensions, 389
 - graphics-handling, 380-381
 - keyboard shortcuts, 367-373
 - limitations, 355
 - master pages, 378
 - style sheets, 375-377

see also FrameMaker;PageMaker;
QuarkXPress**Page Setup command (File menu), keyboard shortcuts, 368****PageMaker**

- advantages, 356
- features
 - CheckList, 393
 - color systems, 383-384
 - embedded graphics, 380-381
 - foreign language extensions, 389
 - Kerning, 379
 - keyboard shortcuts, 368-373
 - master pages, 378
 - mini-saves, 395
 - navigational tools, 374

- style sheets, 376-377
- typographical controls, 357
- mailing lists, 354
- newsgroups, 354
- plug-ins, 366
- PostScript files, generating, 386-387
- text, exporting, 388
- troubleshooting, 395

PageMill, 280, 481

- ratings, 278

Paint Alchemy 2, 313**Paint Style dialog box, 338****Painter (Fractal Design), 302-303****palettes**

- creating, 285
- keyboard shortcuts, 370
- System Palette, 454-455

Panasonic drives, 202**panning, 167****Pantone, 382-384****PaperDirect, 509****Parameter RAM (PRAM), 95-96****Partial Response Maximum Likelihood (PRML), 194****partitions (memory), calculating, 111****passive virus protection, 124****Password Security extension, 92****PastboardXT, 366****Paste command (Edit menu), 8**

- keyboard shortcuts, 371

paths (Infini-D), 412-413**patterned fills, printing, 391**

patterns (desktop)

- applying to utilities, 10
- customizing, 8-11
- designing, 12
- setting, 7

PC cards, 60-61

- digital photography applications, 61-62
- readers, 62

PC Exchange, 511, 514

- ratings, 512

PCMCIA (Personal Computer Memory Card Industry Association), 50, 60-62**PCs**

- files, translating, 387
- Macintosh compatibility, 511

PCX, 299**PDF (Portable Document Format), 283, 520****PDS (Processor Direct Slot), 118****Peachpit Press, 444****Peachtree Accounting, 493****Pen tool, 333**

- FreeHand, 342
- Illustrator, 344

performance, optimizing, 103

- hardware
 - accelerators, 117-121
 - hard drives, 104-110
- memory, 110-117
- software, 121-123

peripherals

- Macintosh/PC compatibility, 521-522
- purchasing, 147
- tablets, 185-187
- trackballs, 181-184
- trackpads, 184

Personal Information

Managers, see PIMs

Personal Computer Memory Card Industry Association (PCMCIA), 50, 60-62**Perspective, 289****Persuasion (Adobe), 504****Phaser printers, 237-238****Philips Electronics, CDD2000 drives, 202****PhoneDisc, 508****Photo CD file format, 299****PhotoDisc, 273**

- URL, 291

photography, digital, 61-62**PhotoLab, 315****Photomatic, 318****PhotoNavigator, 316****photos**

- reducing, 11
- viewing, 12

Photoshop, 306, 401

- automating
 - AppleScript, 317
 - Batch-It!, 318-319
 - Photomatic, 318

- cache cards, 311

- Clipboard, exporting to, 310

- colors, calibrating, 319-322

- desktop patterns

- creating, 11
- customizing, 8

- file formats, 299

- hard drives, 310

- icons, creating, 17-18

- Illustrator files, importing, 319

- mailing list, 289

- plug-ins, 315-317

- Adobe Gallery Effects, 314

- Convolver, 312

- filters, 316

- Kai's Power Tools, 311-312

- Xaos Tools, 313

- RAM, 308-309

- ratings, 307

Pianzhang, 366**PICT (Macintosh Picture) file format, 299****PICT Resource format, 299****Pictura 310 printers, 238****PIMs (Personal Information Managers), 476, 500-503****pincushioning monitors, 167****Pinnacle Micro drives, 202****Pixar format, 300****pixelated images, 295****PixelPaint, 300****pixels, 294-295, 451-452**

- pixels per inch (PPI), 161-162, 295

Place command (File menu), 319**PlainTalk, 86-88****Plasmon drives, 202****PlayWrite drives, 202****plug-ins, 122**

- distortion plug-ins, 338

- filters, 338

- Netscape Navigator, 270

- PageMaker, 366

- Photoshop, 315-316

- Convolver, 312

- Gallery Effects, 314

- Kai's Power Tools, 311-312

- Xaos Tools, 313

- PM-QXT XTension, 388**
- PNG (Portable Network Graphics) format, 300, 517**
- Portable Document Format (PDF), 283**
- Portable Network Graphics (PNG) format, 300, 517**
- PostScript, 226, 327**
 - files, generating, 386-387
 - outline fonts, 70
 - printers, troubleshooting, 397
- PostScript file dialog box, 386**
- Power Computing, 143**
 - Macintosh clones, 145-146
- Power Mac Pruning Web page, 91**
- Power Macs**
 - refresh rates, 67
 - system requirements, 113-114
- PowerBar, 132**
- PowerBook extensions, Password Security, 92**
- PowerDrive, 202**
- PowerPCs**
 - microprocessors, choosing, 136-137
 - system specifications, 145-146
- PowerPlug, 92**
- PowerPoint, 504-506**
- PowerPrint, 522**
- PowerTalk, 87**
- PPARC (Palo Alto Research Center), 3**
- PPI (pixels per inch), 161-162, 295**
- PRAM (Parameter RAM), 95-96**
 - corruption, 116
 - resetting, 117
- Preferences command (File menu), keyboard shortcuts, 368**
- Preferences files, 391-392**
- Preferences menu commands, Monitor Preferences, 320**
- preflighting, 390-393**
- Premiere, 402**
 - ratings, 462
- Prepress Digest, 354**
- PrePress Online, 291**
- presentation software, 503-507**
- PressView, 165**
- PressWise, 385**
- Primax scanners, 217**
- Primera Pro printers, 239**
- print servers, 227, 254**
- print speeds, 227**
- printers, 221**
 - choosing, 225-226
 - connectivity, 228
 - DPI (dots per inch), 327
 - drivers, 228-231
 - dye-sublimation, 223-224, 238-239
 - fonts, 227
 - inkjet, 222-223, 232-234
 - interpolation, 224
 - laser, 223, 234-237
 - Macintosh/PC compatibility, 522
 - print speeds, 227
 - resolution, 296
 - thermal-wax, 223, 238-240
 - troubleshooting, 397
- printing**
 - envelopes, 483-484
 - font samples, 80
 - print quality, 295-296
 - troubleshooting, 397
- Printing Inks preferences files, creating, 320-322**
- Printing inks Setup dialog box, 321-322**
- PRML (Partial Response Maximum Likelihood), 194**
- process colors, 382**
- processing images, 293-294**
 - color models, 297
 - file formats, 298-300
 - software, 300-307
- Processor Direct Slot (PDS), 118**
- processor speeds, 138, 141**
 - increasing, 118-119
- product ratings, see ratings**
- productivity, increasing, 130-133**
 - automation, 125-127
 - utilities, 128-129
- programs, see names of individual software programs**
- Project Window (ElectricImage), 430**
- ProMax drives, 206**
- protocols**
 - AFP (AppleTalk Filing Protocol), 253
 - Ethernet, 3
 - FTP (File Transfer Protocol), 288
 - NBP (Name Binding Protocol), 246
 - TCP/IP (Transmission Control Protocol/Internet Protocol), 253

ZIP (Zone Information Protocol), 246

PSFontReport, 393

purchasing

hardware

adaptors, 168-169

computer systems, 143-146

drives, 139-141, 193-195, 198-203

microprocessors, 136-137

modems, 265-266

monitors, 150-172

printers, 223-226, 232-240

tapes, 196-197, 204-205

peripherals, 147

keyboards, 173-178

mouse, 179-181

tablets, 185-187

trackballs, 181-183

trackpads, 184

memory, 62, 112-114, 137-139, 141

brokers, 63

catalogs, 64

cost considerations, 65-66

questions to ask, 66-67

VRAM, 59

software

3D illustration, 399-402

accounting packages, 492-494

image processing, 300-307

page layout, 354-365

PIMs (Personal Information Managers), 500-503

time trackers, 494-498

Q

QMS printers, 237

QPS (Quark Publishing System), 364-365

Qualcomm (Eudora), 291

Quantum drives, 205

Quark

Connect, 365

CopyDesk, 364

Dispatch, 364-365

Immedia, 353

Publishing System (QPS), 364-365

Xposure, 353

XPress, 376-377, 393-395

advantages, 356

features, 379-384

files, 386-388, 396

keyboard shortcuts, 368-373

mailing lists, 354

ratings, 353

troubleshooting, 395-397

version 4.0, 361

XTensions

disabling, 396

INposition Lite, 385

MarksToolsII, 395

Passport, 389

QuickBooks, 498

QuickDraw, 70, 74, 226

QuickDraw Manager, 4

Quicken, 499

QuicKeys, 367

ratings, 127

QuickShow, 26-27

QuickTake Camera, 468

QuickTime

movies

creating, 468

playing, 465, 473

Musical Instruments, 92, 457-458

PowerPlug, 92

Quit command (File menu), keyboard shortcuts, 368

quitting applications, force quits, 37

R

Radius monitors, 166

RAIDs (redundant arrays of inexpensive drives), 205-206

Rails (Infini-D), 412-413

RAM (Random Access Memory), 50-52

allocating, 56-59

consumption, decreasing, 88

deallocating, 89

disks, 50, 113

drives, 192

fragmentation, 56

installing, 64-65

interleaving, 114-115, 138-139

partitions, 111

performance, 110-113

Photoshop, 308-309

purchasing, 62-64, 112-114, 137-141

cost considerations, 65-66

questions to ask, 66-67
 scanners, 212
 SRAM (Static Random Access Memory), 59-61
 VRAM (Video Random Access Memory), 58-59
RAM Charger, 55
RAM Doubler, 54, 111
 extension conflicts, 96
 ratings, 55
Random Access Memory, see RAM
Raster, 158-159
ratings
 hardware
 Apple Adjustable keyboard, 174
 Apple printers, 228
 Apple monitor, 168
 Color StyleWriters (Apple), 232
 Compact Pro, 196
 Hewlett-Packard scanners, 216
 HP DeskWriters, 233
 HP LaserJet 4MV, 236
 Iomega Zip, 198
 NEC monitors, 156
 Radius monitors, 166
 Sony, 150
 StuffIt Lite, 197
 SyQuest, 199-200
 Umac scanners, 218
 video cards, 120
 ISPs (Internet Service Providers)
 America Online, 262
 CompuServe, 284

peripherals
 Apple mouse, 179
 TurboMouse, 182
 software
 Acrobat, 520
 After Effects, 448
 Anarchie, 288
 Apple Guide, 6
 Apple QuickTake Camera, 468
 AppleScript, 128
 BBEdit, 280
 Claris Emailer, 287
 ClarisWorks, 487
 Conflict Catcher, 89
 Director, 450
 Disinfectant, 125
 Eudora, 287
 Eudora Lite, 287
 Excel, 504
 Extension Manager, 85
 Fetch, 288
 FileMaker Pro, 497
 Fontographer, 81
 Fractal Design Painter, 302-303
 FreeHand, 328
 Frontier, 127
 Gallery Effects, 314
 Illustrator, 328
 Internet Explorer, 281-282
 Kai's Power Tools, 312
 Live Picture, 305-306
 MacInTax, 499
 Master Juggler, 77
 Photoshop, 307
 PowerPoint, 504
 Navigator, 267

NewsWatcher, 261
 Nisus Writer, 478
 Norton Utilities, 109
 Now Contact, 476
 OmniPage, 210
 PageMaker, 353
 PageMill, 278
 PC Exchange, 512
 Persuasion, 504
 PlainTalk, 88
 PowerTalk, 87
 Premiere, 462
 PressView, 165
 QuarkXPress, 353
 Quicken, 499
 QuicKeys, 127
 RAM Doubler, 55
 RealAudio, 270
 SAM (Symantec Anti-virus), 124
 Shockwave for Director, 271
 SoftWindows, 519
 Streamline, 326
 StuffIt Deluxe, 197
 Suitcase 3.0, 76
 Type Manager, 79
 Type Reunion, 79
 Videoshop, 464
 VideoVision, 466
 Virex, 123
 Word 5.1, 477
 WordPerfect, 479
 Works (Microsoft), 487

RAW file format, 300
ray tracing, 295
RCD 5040 drives, 202
Ready,Set,Go! GX, 352

RealAudio
 ratings, 270
 URL, 289
rebuilding desktop, 35, 106-107
rec newsgroups, 262
recording sounds, 463
recovering data, 36
reducing monitor glare, 165
referencing graphics, 380-381
Reflect tool, 337
refresh rates, 157
 memory modules, 67
registering WWW (World Wide Web) pages, 281-282
reimporting graphics (QuarkXPress), 396
reinstalling OS (operating system), 35
Relisys scanners, 217
remote access servers, 255
removable drives
 choosing, 140-141
 Iomega Zip, 197-198
 LaCie, 200
 SyQuest, 199-200
removable storage, 190
removing
 control panels, 86-87, 91-92
 DOS line feed characters, 517
 extensions, 86-89, 91-92
rendering, 403
 form•Z, 423-426
replacing
 ABD (Apple Desktop Bus) connectors, 174
 clock chips, 119

researching clients/industries, 277
ResEdit icons, customizing, 18
resetting RAM, 115-117
resizing icons, 15
resolution
 images, 294-296
 monitors, 161-162, 296
 multimedia graphics, 451-452
 scanners, 210
 WWW (World Wide Web) images, 284
resolving conflicts
 extensions, 93
 automated resolution, 95-96
 manual resolution, 94-95
 fonts, 77-78
Resource menu commands, Create New Resource, 18
restricting file access, 251
Retrospect, 40
RGB (red, green, blue) color model, 297
ripping to screen, 303-305
robots, 271
ROM, 4-5
Rotate tool, 337
rotation (monitors), 167

S

S video cables, 174
SAM (Symantic Anti-virus), 124
sampling rates, 460-461
Sandra's ClipArt server, 291
Save As command (File menu), keyboard shortcuts, 368
Save command (File menu), keyboard shortcuts, 368
saving files, Autosave, 394
SavvySearch, 291
Scale dialog box, 337
Scale tool, 337
ScanMate scanners, 220
scanners, 209
 alternatives, 213
 CCDs (charge-coupled devices), 210
 color depth, 211
 drum scanners, 213, 219
 dynamic range, 212
 flatbed scanners, 214
 interpolation, 211
 manufacturers
 Apple, 215
 Epson, 216
 Hewlett-Packard, 216
 LaCie, 217
 Nikon, 219
 Primax, 217
 RAM, 212
 Relisys, 217
 ScanView, 217
 Umax, 218
 resolution, 210
 slide scanners, 212, 218
scanning images, 382
ScanView scanners, 217
sci newsgroups, 262
Scitex CT file format, 300
Scrapbook, 26
Scratch Disks (Photoshop), 310
scratch space, 108

- screens**
 - captures, 27-28
 - curvature (monitors), 154-155
 - resolution, 451-452
- scripts, see Managers**
- SCSI (Small Computer System Interface), 140-141, 192-193**
 - IDs, setting, 207
 - Macintosh/PC compatibility, 522
- Seamless Welder filter, 11**
- search engines, 271-273**
 - URLs, 291
 - WWW (World Wide Web) pages, registering, 281-282
- searching WWW (World Wide Web), 271-272**
- Second Glance, Photoshop plug-ins, 316**
- secondary monitors, purchasing, 153-159**
- security backups, 41**
- Seiko printers, 240**
- Select All command (Edit menu), 18**
- Select New Type box, 18**
- Select Phone, 508-509**
- selecting**
 - desktop patterns, 7
 - labels, 101
- Selection tools, 336**
- Self-Copy modifiers, 426**
- sending faxes, 489-490**
- sequencing software, EZVision, 458**
- serifs, 74**
- server**
- servers, 253-254**
 - backing up, 42-43
 - email servers, 254
 - software, NetPresenz, 288
- service providers, see ISPs (Internet Service Providers)**
- Set Desktop Pattern button, 7-9**
- setting**
 - desktop patterns, 7
 - internal SCSI IDs, 207
 - monitor preferences, 320
- ShadowCatchers (Infini-D), 410**
- Sharing command (File menu), 248**
- Sharing Setup control panel, 246**
- Sharpen Edges filter, 11**
- Shear tool, 337**
- Shockwave for Director, 271**
- shooting video, 468**
- shopping tips, see purchasing**
- Show Comments option (Views control panel), 15**
- Show Disk Info In Header option (Views control panel), 15**
- Shrinkwrap, 34**
- silhouettes, creating, 382**
- SIMMs (Single Inline Memory Modules), 50**
 - interleaving, 114-115
- single-button mouse, 179**
- SiteMill, 280**
- sites, WWW (World Wide Web)**
 - 3D Design resources, 444
 - Casady and Greene, 92
 - Complete Conflict Compendium (C3), 94
 - Design Tools Monthly*, 366
 - Gamma (Knoll Software), 165
 - graphics FAQs, 165
 - MacAlly, 177
 - Macintosh Extensions Guide, 91
 - Macromedia, 473
 - modem information, 266
 - Power Mac Pruning Page, 91
 - reference chart, 289-291
 - storage device FAQs, 208
- Size view, 13**
- sizing icons, 15**
- Sledgehammer disk arrays, 110**
- slide scanners, 212, 218**
- slide shows, creating, 504-506**
- Small Computer System Interface, see SCSI**
- Small Icon view, 13**
- SmallTalk, 3**
- smart quotes, 486**
- SmartXT, 316**
- soc newsgroups, 262**
- SoftPC, 518-519**
- Softpress Systems, UniQorn, 355**
- software**
 - downloading, WWW (World Wide Web), 274-275

- organizing, 46-47
 - see also* names of individual software packages
- SoftwareDesignSpec, 496-498**
- SoftWindows, 473, 517-519**
- Sony monitors, 150**
- Sound control panel, 97**
- SoundEdit 16, 98, 460-461**
 - 8/22 sounds, creating, 463
- SoundExtractor, 289**
- SoundHack, 289**
- SoundMachine, 289**
- sounds, 97-98**
 - CD audio, 458
 - creating, 455
 - digital audio, 459-463
 - MIDI files, 456-458
 - synthesized speech, 458-459
 - synchronizing, 465
- spanned drives, 205**
- spatial compression, 467**
- Special menu commands, Erase Disk, 513**
- Specular**
 - BackBurner, 402
 - Collage, 316
 - Infini-D, 400
 - Infini-D Production Studio, 403
 - LogoMotion, 400
 - TextureScape, 401
 - URL, 444
- speech, synthesizing, 458-459**
 - MacinTalk, 86
 - PlainTalk, 86-88
 - ratings, 88
- Speed Disk, 108-109**
- Speed Doubler, 122-123**
- speeds**
 - printers, 227
 - processors, 118-119
 - RAM, 112-116
 - video cards, 120
- spelling checkers, 486**
- SplineForms, 411-413**
- spot color systems, 382-384**
- spreadsheets, importing from Windows, 515**
- SRAM (Static Random Access Memory), 50, 59-61**
- stacks, 52**
- Stanford University URL, 291**
- STAR configuration, 256**
- Star Trek: The Next Generation's StarDate, 502**
- Startup Manager, 88, 92**
 - conflict resolution, 95-96
- static memory, PC cards, 61**
- Static Random Access Memory, *see* SRAM**
- Stickies, 25**
- Stingray trackballs, 183-184**
- Stochastic screening, 382**
- stock houses, 273**
 - URLs, 291
- Stock solution, 291**
- storage devices**
 - access/transfer rates, 193
 - cabling, 192-193
 - choosing, 189-192
 - disks, 196-197
 - drives, 198, 203
 - Iomega Zip, 197-198
 - LaCie Joule, 200
 - optical, 194-195, 201-202
 - SyQuest, 199-200
 - Winchester, 193-194
 - FAQs Web site, 208
 - tapes, 196-197, 203-205
- storing**
 - files, 38-39, 42-43
 - images, Scrapbook, 26
- Streamline, 325-326**
- Stripper, 122**
- stripping System Folder, 86-89, 91-92**
- strokes, 324**
- StudioPad, 187**
- StuffIt , 197**
 - URL, 291
- style sheets, 375**
- StyleWriters, 323-233**
 - drivers, 229
- styling text, 71-72**
- Stylus printers, 233**
- Submit It!, 291**
- subscribing to newsgroups, 262-263**
- Suitcase 3.0, 75-76**
- suitcases, 75**
- suites (software), 488-489**
- Sunrise, Chinese Environment, 389**
- SuperFlares (Infini-D), 407**
- Surface Floater (Infini-D), 408**
- surfing the Internet, 263-269**
- SyJet drives, 203**

- Symantec**
 - Anti-virus (SAM), 124
 - Sam, 37
 - Suitcase 3.0, 75-76
 - synch-on-green problems (monitors), 169-170**
 - synthesized speech, 458-459**
 - SyQuest, 192**
 - drives, 197-200, 203
 - System 6, Font/DA mover, 33**
 - System 7.0**
 - fonts, installing, 70
 - system suitcase, 97
 - System 7.1**
 - fonts, installing, 70-71
 - system suitcase, 97
 - System 8 (Copland), 6**
 - System File, 4-5**
 - System Folder, 4, 83**
 - control panels, 84
 - adding, 85
 - memory requirements, 88
 - removing, 86-87, 91-92
 - extensions, 84, 91-92
 - adding, 85
 - conflicts, 93-96
 - identifying, 90
 - memory requirements, 88
 - removing, 86-89, 91-92
 - files, organizing, 99-101
 - System option (Photoshop palettes), 285**
 - System Palette, 454-455**
 - System requirements, 142-146**
 - memory, 54, 141
 - multimedia, 447
 - processor speed, 141
 - System 8, 6
 - System suitcase, 96**
 - keyboard layouts, 98-99
 - sound files, 97-98
 - System, *see* OS (operating system)**
 - system-wide accelerators, 118-120**
- I**
- T1 connections, 264**
 - Table editor (FrameMaker), 363**
 - tablets, 185-187**
 - Tagged Image File Format (TIFF), 300**
 - tags**
 - HTML (HyperText Markup Language), 278, 479-481
 - viewing, 279
 - Netscape, 281-282
 - PageMaker, 377
 - XPress, 377
 - talk newsgroups, 262**
 - tape drives, 41**
 - tapes**
 - 8mm, 204-205
 - choosing, 196-197
 - DAT (digital-audio technology), 204
 - DLT (digital-linear tape), 204-205
 - Targa (TGA) file format, 300**
 - tasks, automating, 125-127**
 - TCP/IP (Transmission Control Protocol/Internet Protocol), 253, 260**
 - technical publications, page layout software, 358**
 - TechTool, 96, 107, 117**
 - Teknoskys, Help!, 38**
 - Tektronix printers, 234, 237-238**
 - Telecom software, 514**
 - templates, tracing, 327**
 - Tempo II Plus, 367**
 - temporal compression, 467-468**
 - Terrazzo, 11, 313**
 - testing multimedia, 451**
 - text**
 - exporting, 388
 - fonts
 - creating, 81
 - Multiple Master fonts, 73-74
 - organizing, 74-79
 - printing, 80
 - types, 70-71
 - kerning, 72-73, 378-380
 - styling, 71-72
 - Text Wizard, 315**
 - texture, adding to tiles, 11**
 - Texture Maker, 11**
 - TextureScape, 401**
 - texturizers**
 - KPT Texture Explorer, 11
 - Paint Alchemy 2, 313
 - TGA (Targa) file format, 300**
 - theoretical maximum capacity, 41**
 - thermal-wax printers, 223**
 - manufacturers, 238-240

Thinking mouse, 180
 thumbnail drag technique, QuarkXPress, 396
 TIFF (Tagged Image File Format), 300, 381
 Tile Documents command (View menu), 396
 Tile library, 10
 Tiles (desktop patterns), 7
 deleting, 10
 grids, creating, 12
 library, 10
 modifying, 8
 texture, adding, 11
 Timbuktu Remote, 188
 time, managing, 32-33
 Time mode (ElectricImage), 430
 time-tracking software, 494-498
 TimeSlice, 495
 TimeTracker, 494-495
 Toby cards, 159
 Token Ring, 92
 Tony Stone Images, 291
 Toolbox, 4
 Infini-D, 406-408
 Managers, 4-5
 tools
 ElectricImage, 429-431
 form•Z, 418-420
 Illustrator, 334-336
 Infini-D, 406-408
 Tools menu commands
 Envelopes and Labels, 483
 Topological Level Modifiers (form•Z), 419, 426
 topologies, bus, 256
 Total Integration, Inc., Photoshop plug-ins, 316-317

Touché trackpads, 184
 Tracer, 326
 tracing templates, 327
 Trackball Pro, 183
 trackballs, 181-184
 trackball keyboards, 175
 tracking, 378-380
 trackpads, 184
 trackpad keyboards, 176
 Transfer rates, 193, 264
 Transfer Settings dialog box, 514-515
 transferring files, 287
 FTP (File Transfer Protocol), 288
 to PCs, 512-517
 translating files, 387-388
 DOS/Windows files, 516-517
 translators, DataViz, 517
 transparent GIFs, 286
 Tree Pro, 433
 Trojan horses (viruses), 125
 troubleshooting
 diagnostic software, 38
 extension conflicts, 94-96
 files
 graphics files, 382
 output, 390-393
 memory installation, 65
 monitors
 distortion, 164
 greenish casts, 169-170
 resolution, 161-163
 shimmying/shaking, 169
 PageMaker, 395
 printing problems, 397
 QuarkXPress, 395-396

Tru-Form keyboards, 176
 TrueType fonts, 70-71
 TruMatch, 383-384
 Turbo trackball, 182
 TurboMouse, 182
 turning off extensions, 91-92
 MacBinary formatting, 514-515
 type
 blending, Fontographer, 81
 foreign language type-faces, 389
 kerning, 72-73, 378-380
 samples, printing, 80
 styles, 71-72
 see also fonts
 Type 1 fonts, 70-71
 Type I/II/III cards, 61
 Type Manager (Adobe), 70, 78-79
 Type Reunion, 79
 TypeBook, 80
 Typecaster, 313
 TypeIndexer, 80
 typographical controls
 Illustrator, 340
 PageMaker, 357

U

Umax scanners, 218
 UNB Graphics Services, 289
 “unexpected quit” error messages (QuarkXPress), 395-396
 UniQorn, 355, 365
 University of Michigan Mac Archive, 291
 unlinked files, 469-471
 Unsharp Mask filter, 11

upgrading

- memory, 62-67
- storage, 191-192
- systems, 139

URLs (uniform resource locators)

- Casady and Greene, 92
- Complete Conflict Compendium (C3), 94
- Design Tools Monthly, 366
- Gamma (Knoll Software), 165
- graphics FAQs, 165
- loading, 267
- MacAlly, 177
- Macintosh Extensions Guide, 91
- Macromedia, 473
- Now Utilities, 92
- Power Mac Pruning Page, 91
- reference chart, 289-291
- storage device FAQs, 208

Usenet, 261

- newsgroups, 262-263
- URL, 289

Users & Groups control panel, 249**utilities, see names of individual utilities**

V**Variables feature****(FrameMaker), 361****vector-based images, 295****vectors, 323-324****Velocity dialog box, 408****Veronica, 272-273****video**

- adaptors, 168-169
- cards, 168
 - manufacturers, 170
 - speeds, 120
- digital, 464
 - capturing, 468
 - compressing, 465-468
 - editing, 468
 - soundtracks, synchronizing, 465

Videoshop, 464**VideoVision, 466****View menu commands (Tile Documents), 396****viewers, 521****viewing HTML tags, 279****views, 13-14**

- ElectricImage, 429-430
- keyboard shortcuts, 372

Views control panel, 14**Views Floater (Infini-D), 407****View menu, 13-14****Virex, 37**

- ratings, 123

virtual memory, 53

- file mapping, 54
- Photoshop applications, 308

viruses, 36-37, 123

- protection software, 124-125
- Trojan horses, 125

Visionary Software

- First Things First PIM, 502-503
- LifeGuard, 509-510

VivaPress Professional, 355**VRAM, 58-59, 116-117**

W**Wacom tablets, 186****Waves Technology, L1 filter, 462****Web, see WWW (World Wide Web)****WebCrawler, 291****WestCode, OneClick, 127, 132-133****What You See Is What You Get, see WYSIWYG****What's New lists, 282****white points, 165****Will Harris House, 289****Winchester-style drives, 193-194****Windows, 511**

- customizing, 13
- emulation software, 473
- files
 - exporting to Macintosh, 512-515
 - formats, 44
 - translating, 516-517
- fonts, 14
- icons
 - aligning, 14
 - customizing, 15
 - labeling, 15-16
- Macintosh compatibility, 515-517
- multimedia playback, 473
- telecom software, 514
- views, 13-14

Wireframe files, 295**wireless networks, 257****Word, 477**

- AutoCorrect, 486

envelopes, printing, 483-484

Mail Merge, 485

word processors

envelopes, printing, 483-484

grammar checkers, 486-487

letters, creating, 482-483

mail merges, 484-485

programs

- ClarisWorks, 481
- Nisus Writer, 478
- Word, 477
- WordPerfect, 478-479
- WriteNow 4.0, 482

spelling checkers, 486

typewriters, compared, 486

WordPerfect, 478-479

- Envoy, 519-521

workflow, organizing, 45-47

WorkGroup Server 60

- memory refresh rates, 67

works programs, 487-488

Workshop (Infini-D), 411-413

workspaces, organizing

- aliases, 130
- button bars, 131-132

World (Infini-D), 405

- Boolean functions, 410
- ShadowCatchers, 410
- surface composition, 410
- tools, 406-408
- velocity controls, 408

WorldScript, 389

Worm drives, 195

WriteNow 4.0, 482

- Grammatic Mac, 486

WWW (World Wide Web), 260

browsers

- Internet Explorer, 281-282
- Netscape Navigator, 267, 270

commercial uses, 276-277

graphics, downloading, 270

multimedia, playing, 449

pages, 479-481

- creating, 278-280
- links, 270
- marketing, 281-282

resources

- design information, 275-276
- font houses, 274
- software suppliers, 275
- stock houses, 273

search engines, 271-272

- URLs, 291

sites

- 3D design resources, 444
- Casady and Greene, 92
- Complete Conflict Compendium (C3), 94
- Design Tools Monthly, 366
- graphics FAQs, 165
- MacAlly, 177
- Macintosh, Extensions Guide, 91

Macromedia, 473

modem information, 266

Now Utilities, 92

Power Mac Pruning Page, 91

reference chart, 289-291

storage device FAQs, 208

WWW Virtual Library, 289

WYSIWYG (What You See Is What You Get), 69, 480

- menus, 81

X

X-height, 74

Xaos Tools

- Photoshop plug-ins, 313
- Terrazzo, 11

XChange, 366

Xerox

- PARC (Palo Alto Research Center), 3
- printers, 237

XL1208 printers, 235

XPress (Quark), 376-377, 393-395

- advantages, 356
- features, 379-384
- files, 386-388, 396
- keyboard shortcuts, 368-373
- mailing lists, 354
- ratings, 353
- troubleshooting, 395-397
- version 4.0, 361

XPrint printers, 237

xRES, 303-305

XTensions (Quark)

disabling, 396

MarksToolsII, 395

Passport, 389

Xyvision, Advent 3B2, 355

Y-Z

Yahoo, 271

URL, 289

**Yale C/AIM WWW Style
Manual, 290**

Yamaha drives, 202

**Ziffnet, Mac's Clean Sweep,
105-106**

**ZIP (Zone Information
Protocol), 246**

Zip drives, 140-141, 197

ratings, 198

zooming, 167

